

Catalog Numbers • Les Numéros de Catalogue • Números de Catálogo: PW-100D/PW-101D

Country of Origin: Made in China • Pays d'origine: Fabriqué en Chine • País de origen: Hecho en China

SPECIFICATIONS

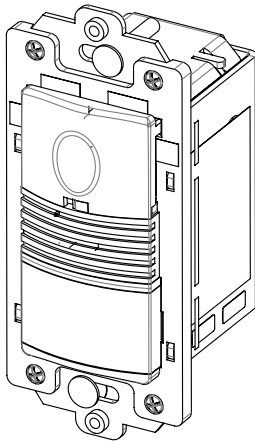

Voltages:

PW-100D 120/277VAC, 50/60Hz
PW-101D 120VAC, 50/60Hz

Load Limits for each relay:

@120VAC 700W Single Gang, 400W Two Gang, 350W Three Gang
@277VAC (PW-100D only) ... 1200W Single Gang, 900W Two Gang, 800W Three Gang

Load Type Compatibility:

PW-100D Incandescent, Ballast and 2-wire Fluorescent Ballast
PW-101D Incandescent, Ballast, Quartz Halogen, Magnetic Low Voltage,
..... LED and 2-wire Fluorescent Ballasts

Time Delay Adjustment 5 to 30 minutes

Walk-Through Mode 3 minutes if no activity after 30 sec.

Test Mode 5 sec. at initial power up or DIP switch reset

PIR Adjustment High or Low (DIP switch)

Light Level Adjustment 8fc to 180+fc

Alerts Selectable Audible

Fade rates 1.5 seconds to turn ON, 5 seconds to turn OFF

DESCRIPTION AND OPERATION

The PW Passive Infrared Dimmable Wall Switch sensors use advanced passive infrared (PIR) technology.

The PW sensor can turn a load **ON**, and hold it **ON** as long as the sensor detects occupancy. After no movement is detected for the selected time delay, the lights switch **OFF**. A “walk-through” mode can turn lights **OFF** after only 3 minutes, if no activity is detected after 30 seconds following an occupancy detection.

The PW sensor contains dimming capability so that the user can set the ideal light level for any occasion. The user is able to set the desired preset level so that the lights will always turn **ON** to this level.

The PW has one relay and one **ON/OFF** button. Pressing a button toggles the state of the corresponding relay. Pressing and holding the button will dim the lights up or down. A double tap to the button will turn the lights **ON** to full bright.

PW sensors contain a light level sensor. If adequate daylight is present, the sensor holds the load **OFF** until light levels drop, even if the area is occupied. Users can override this function by pressing the **ON/OFF** button. See Light Level Adjustment.

Time Delays

The PW sensor holds the load **ON** until no motion is detected for the selected time delay. Select the time delay using DIP Switch Settings.

NOTE: Shaded cells below indicate default operation and switch setting.

Test/20 min (DIP #1, 2, & 3 OFF)	A Test Mode with a short time delay of 5 seconds is set when DIP Switches 1, 2, & 3 are OFF . It cancels automatically after ten minutes, or when you set a fixed time delay. When the Test Mode times out, the sensor assumes a 20 minute time delay. To restart Test Mode, change the time delay setting to any fixed amount, and then return it to the Test setting.
Fixed Time Delay (DIP #1 ON , 2 & 3 OFF)	Time delays are 5, 10, 15, 20 (default), 25, or 30 minutes.

Walk-Through

The Walk-Through mode shortens the time delay to reduce the amount of time the load is **ON** after a brief moment of occupancy, such as returning to an office to pick up a forgotten item, then immediately exiting.

Walk-Through Mode (DIP #4 ON)	The PW sensor turns the load OFF three minutes after the area is initially occupied, if no motion is detected after the first 30 seconds. If motion continues beyond the first 30 seconds, the set time delay applies.
No Walk-Through (DIP #4 OFF)	Walk-Through mode disabled.

PIR Sensitivity Adjustment

The PW sensor constantly monitors the controlled environment and automatically adjusts the PIR to avoid common ambient conditions that can cause false detections, while providing maximum coverage.

High (DIP #5 OFF)	Default setting. Suitable for most applications.
Low, 50% (DIP #5 ON)	Reduces sensitivity by approximately 50%. Useful in cases where the PIR is detecting movement outside of the desired area (also consider masking the lens) and where heat sources cause unnecessary activation.

Preset Light Level

The PW dimmable sensor contains a preset light level feature that determines how bright the lights are when they initially turn **ON**. The user has the option to set a locked preset level (factory default is 85% brightness) or let the preset level be the last light level set before the lights were turned **OFF**.

To change the locked preset level, move DIP Switch #6 to the **OFF** position, set the lights to the desired level, and then move DIP Switch to the **ON** position.

Locked preset light level (DIP #6 ON)	The lights will always turn back ON to the locked preset level. Factory default preset is 85% brightness. This allows the lights to turn ON to the same level regardless of the light level when they were turned OFF .
Last light level set (DIP #6 OFF)	When the lights are turned ON the level is the last light level set before the load was turned OFF .

Alerts

The PW can provide audible alerts as a warning before the load turns **OFF**.

Audible Alerts (DIP #7 ON)	Unit will beep at one minute*, at 30 seconds and at 10 seconds before turning OFF load. When Walk-Through is active, the unit beeps three times at 10 seconds before the load goes OFF .
No Audible Alerts (DIP #7 OFF)	No audible warnings provided.

Turning ON the Load

The relay can be set either **Auto ON** or **Manual ON**. In either mode, the load can be turned **ON** or **OFF** using the **ON/OFF** button.

Auto ON (DIP #8 OFF)	Load turns ON and OFF automatically based on occupancy. If the load is turned OFF manually, it stays OFF until 5 minutes after the last occupancy detection, at which time the sensor timeouts. This prevents the load from turning ON automatically after it was deliberately turned OFF . Pressing the button to turn lights ON returns the sensor to Auto ON mode.
Manual ON (DIP #8 ON)	Occupants must press the ON/OFF button to turn ON the load. The sensor keeps the load ON until no motion is detected for the selected time delay. There is a 30 second re-trigger delay. If occupancy is detected during the delay, the sensor turns the load back ON . After the re-trigger delay elapses the ON/OFF button must be pressed to turn ON the load.

Load Control

The type of load that is being controlled will determine the setting of the DIP Switch.

Load Type (DIP #9 ON)	Fluorescent.
Load Type (DIP #9 OFF)	Incandescent (Factory Default).

DIP SWITCH SETTINGS

Time Delay	1	2	3
Test/20 min	↓	↓	↓
5 minutes	↓	↓	↑
10 minutes	↓	↑	↓
15 minutes	↓	↑	↑
20 minutes	↑	↓	↓
25 minutes	↑	↓	↑
30 minutes	↑	↑	↓
Service	↑	↑	↑
Walk-Through	4		
Enabled	↑		
Disabled	↓		
Service bypasses occupancy & light level functions. Control the load manually using the ON/OFF button.			

Time Delay	1	2	3	4
Walk-Through	ON	ON	ON	ON
PIR Sensitivity	5			
Low, 50%	↑			
High	↓			
Preset Light Level	6			
Locked level	↑			
Last level set	↓			
*Factory default 85%				

Audible Alert	7
Enabled	↑
Disabled	↓
ON Mode	8
Manual On	↑
Auto On	↓
Load Type	9
Fluorescent	↑
Incandescent	↓

↑=ON ↓=OFF ◀=Factory Setting

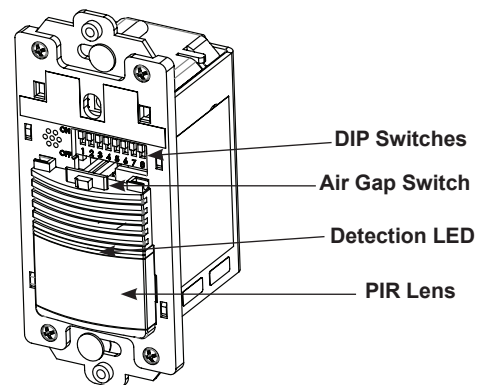
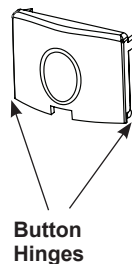

COVERAGE PATTERNS

Coverage testing has been performed according to the NEMA WD 7 guideline. For best performance, use in spaces not larger than 15' x 12'.

PIR Sensor

The sensor has a two-tiered, multi-cell viewing Fresnel lens with 180 degree field of view. The red LED on the sensor flashes when the PIR detects motion.

Masking the lens

Opaque adhesive tape is supplied so that sections of the PIR sensor's view can be masked. This allows you to eliminate coverage in unwanted areas. Since masking removes bands of coverage, remember to take this into account when troubleshooting coverage problems.

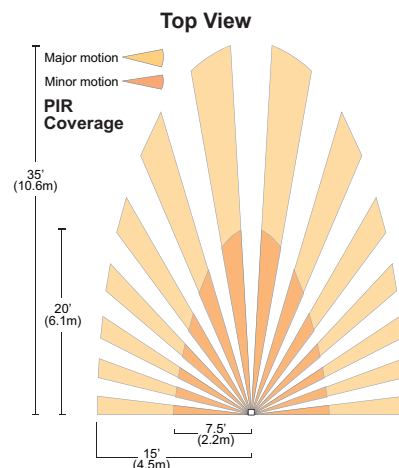
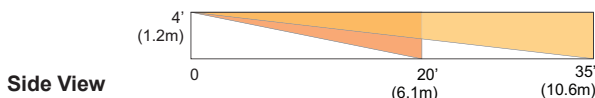

SAFETY FEATURE

Use the air gap switch feature to replace lamps safely. Move air gap switch to right position (**OFF**) and replace lamp. Return the air gap switch to left position (**ON**) after lamp replacement.

INSTALLATION

1. Make sure that the power has been turned **OFF** at the circuit breaker.
2. Connect wires to the PW flying leads as shown in the wiring diagram that are appropriate to the PW model and electrical supply. **The ground wire (green) must be fastened to ground for the sensor to work properly.**
3. Attach the sensor to the wall box by inserting screws into the two wide holes on the top and bottom of the attached metal bracket. Match them up with the holes in the wall box and tighten.
4. Turn the circuit breaker **ON**. Wait one minute, then push the **Auto ON/OFF** switch for each load and the lights will turn **ON**. There is a delay due to initial power-up of the sensor that only occurs during installation.
5. Test and adjust the sensor if necessary.
6. Attach the cover plate.

⚡ **WARNING: TURN THE POWER OFF AT THE CIRCUIT BREAKER BEFORE WIRING.** ⚡

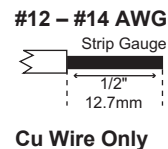

Caution: To reduce the risk of overheating and possible damage to other equipment, do not install to control a receptacle, or a motor-operated appliance, a non-dimmable fluorescent lighting fixture, or a transformer-supplied appliance.

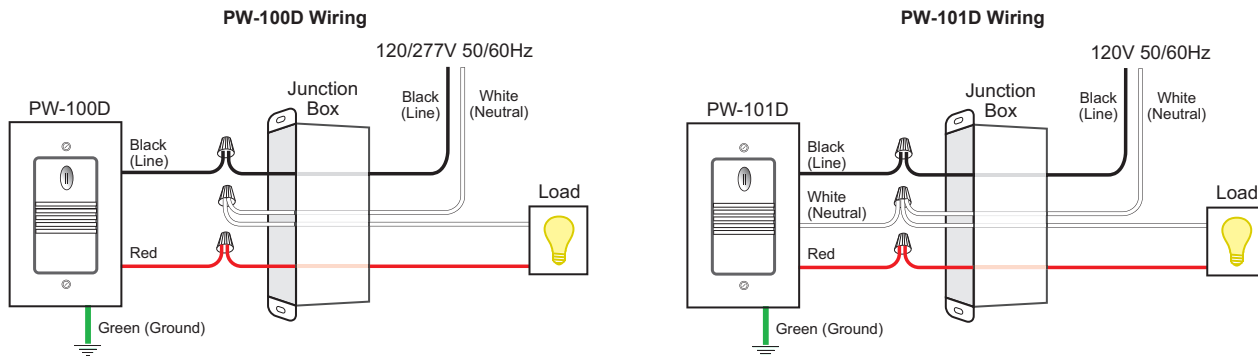

ADJUSTMENTS

Sensor Adjustment

Remove the wall plate. Remove the button cap by firmly squeezing together the top sides of the button assembly. Gently pull it away from the unit.

When the adjustments are completed, replace the button cap by inserting its hinges into the tabs on the main unit and then squeeze the top of the button while pressing it into the unit. Reinstall the cover plate.

Light Level Adjustment

The light level can be set with loads **ON** or **OFF**. To enable light level control and set the threshold: 1) Make sure the room is lit appropriately. 2) Put the sensor into TEST mode (see Time Delay switches). You have 5 minutes to complete the procedure. 3) Press and hold the **ON/OFF** button for 3 seconds, until you hear a beep. 4) Step away from the sensor. After 25 seconds a beep sounds, indicating that the threshold level is set. This threshold is retained, even if power is lost, until it is re-set or disabled.

To disable light level control, press and hold the Relay 1 button for 7 seconds, until a double beep tone sounds.

Reset to Default

To reset the PW to factory settings, press and hold the Relay 1 button for **20** seconds, until a triple beep sounds. This resets the sensor occupancy history and disables light level control (the brightest ambient light will not hold the light **OFF**).

Fluorescent Loads

If controlling a fluorescent load, change DIP Switch #9 to the **ON** position before powering up the device.

TROUBLESHOOTING

Light do not turn **ON** with motion or button press (LED does not flash)

1. Make sure that the air gap switch is set to the **ON** (left) position.
2. If lights still do not turn **ON**, call 800.879.8585 for technical support.

Lights do not turn **ON** with motion (LED does flash)

1. Press and release each button to make sure that the correct lights come **ON** for each relay. If the lights do **NOT** turn **ON**, check wire connections, especially the Load connection. If the lights turn **ON**, verify that the correct **ON Mode** is selected in DIP Switches 8 and 9.
2. Check to see if light level control is enabled: cover the sensor lens with your hand. If the lights come **ON**, adjust the light level setting.
3. If lights still do not turn **ON**, call 800.879.8585 for technical support.

Lights do not turn **ON** with motion (LED does not flash)

1. Press and release each button to make sure that the correct lights come **ON** for each relay. If the lights turn **ON**, verify that Sensitivity is on **High**.
2. Check the wire connections, particularly, the Line connection. Verify that connections are tightly secured.
3. If lights still do not turn **ON**, call 800.879.8585 for technical support.

Lights do not turn **OFF**

1. There can be up to a 30 minute time delay after the last motion is detected. To verify proper operation, set DIP Switch 1 to **ON**, then reset switches 1, 2, and 3 to **OFF** to start Test Mode. Move out of view of the sensor. The lights should turn **OFF** in approximately 5 seconds.
2. Verify that the sensor is mounted at least six feet (2 meters) away from any heating/ventilating/air conditioning device that may cause false detection. Verify that there is no significant heat source (such as a high wattage light bulb) mounted near the sensor.
3. If the lights still do not turn **OFF**, call 800.879.8585 for technical support.

Sensing motion outside desired areas

1. Select PIR Sensitivity – Low (DIP Switch 5 = **ON**) if necessary.
2. Mask the PIR sensor's lens to eliminate unwanted coverage area.

ORDERING INFORMATION

Catalog Number	Description
PW-100D	Passive infrared dimmable wall switch sensor; 120/277VAC, 50/60Hz; 700W incandescent or two-wire fluorescent ballasts
PW-101D	Passive infrared dimmable wall switch sensor; 120VAC, 50/60Hz; 700W universal dimmer

Units come in White (-W), Light Almond (-LA), Ivory (-I), Grey (-G), Black (-B). Add color designator to catalog number when ordering.

WARRANTY INFORMATION

Wattstopper warrants its products to be free of defects in materials and workmanship for a period of five (5) years. There are no obligations or liabilities on the part of Wattstopper for consequential damages arising out of, or in connection with, the use or performance of this product or other indirect damages with respect to loss of property, revenue or profit, or cost of removal, installation or reinstallation.

INFORMATIONS RELATIVES À LA GARANTIE

Wattstopper garantit que ses produits sont exempts de défauts de matériaux et de fabrication pour une période de cinq (5) ans. Wattstopper ne peut être tenu responsable de tout dommage consécutif causé par ou lié à l'utilisation ou à la performance de ce produit ou tout autre dommage indirect lié à la perte de propriété, de revenus, ou de profits, ou aux coûts d'enlèvement, d'installation ou de réinstallation.

INFORMACIÓN DE LA GARANTÍA

Wattstopper garantiza que sus productos están libres de defectos en materiales y mano de obra por un período de cinco (5) años. No existen obligaciones ni responsabilidades por parte de Wattstopper por daños consecuentes que se deriven o estén relacionados con el uso o el rendimiento de este producto u otros daños indirectos con respecto a la pérdida de propiedad, renta o ganancias, o al costo de extracción, instalación o reinstalación.