



EOPC-100

Wireless Lighting Control System
Wireless Self-Powered PIR Ceiling Mount
Extended Range Occupancy Sensor

SPECIFICATIONS

Input Voltage:	Self-Powered, Optional Battery
Operating Life at Full Charge:	72 hrs
Time Delay:	5-30 minute adjustable
Connection to Wireless Network:	Transmits signal to Wall Switch Receiver (EOSW) via Radio Frequency
Environment:	For Indoor Use Only
Operating Temperature:	32° to 131°F (0° to 55°C)
Storage Temperature:	23° to 176°F (-5° to 80°C)
Relative Humidity:	5 to 95% (non condensing)
Patent Pending	

This device complies with part 15 of the FCC rules. Operation is subject to the following two conditions:
 1) this device may not cause harmful interference and 2) this device must accept any interference received, including interference that may cause undesired operation.

UNIT DESCRIPTION

WattStopper's EOPC-100 Wireless Self-Powered Passive Infrared (PIR) Ceiling Mount Extended Range Occupancy Sensor turns loads on and off based on occupancy and ambient light levels. It is self-powered using two built-in solar cells that draws on available ambient light to power itself and can operate for up to 72 hours (3 days) in total darkness. It must be fully charged prior to installation by exposing it to 20fc or 215lux for 4 hours to operate 24 hours, and charge for 12 hours to operate 72 hours. An optional battery (CR2032, or equivalent) can be used for applications without available ambient light, or for instant operation at power up (not included with product).

SENSOR PLACEMENT (12' MAX. HEIGHT)

PLACEMENT GUIDELINES

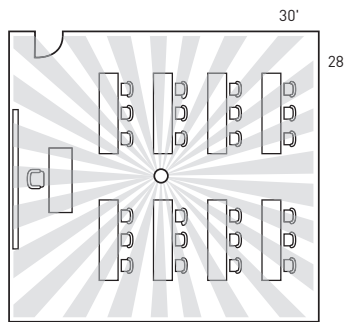

○ Sensor

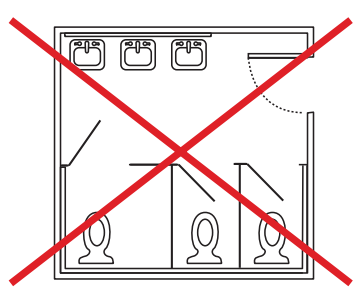

Warning: Do Not Mount in a dark room (< 3 fc).
 If necessary, please insert optional battery.

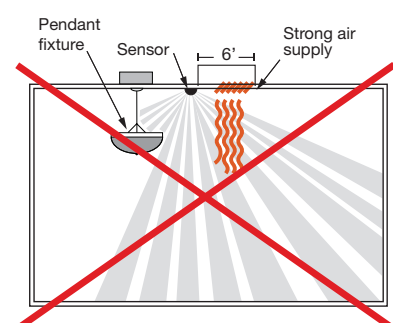

Mount sensor at least 6' away from air supply.
 Avoid obstacles that block sensor's line-of-sight.

COVERAGE PATTERN

The EOPC-100 provides a 360° coverage pattern. The coverage shown represents maximum coverage for walking motion at a mounting height of 8 feet.

Masking the PIR Lens: Opaque adhesive tape is supplied so that sections of the PIR lens can be masked. This restricts the sensor's view and allows you to eliminate PIR coverage in unwanted areas such as hallways outside of the desired coverage area. Since masking removes bands of coverage, remember to take this into account when troubleshooting coverage problems.

TOP VIEW
 44ft diameter @8ft

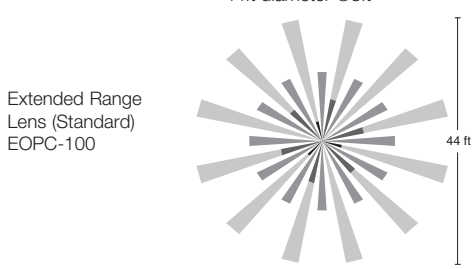

Extended Range Lens (Standard)
 EOPC-100

SIDE VIEW
 Extended Range Lens (Standard)

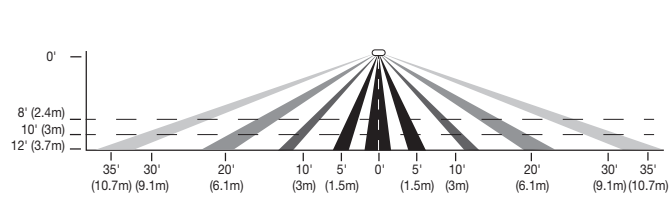

OPERATION

The EOPC-100 depends on either the EOSW-101/102 or EOSW-111/112 Wireless Receiver for operation. In order to establish communication with one another, all devices need to be Paired together. Pairing refers to establishing a link between two or more devices for communication purposes. The EOPC can only be Paired to other devices as it has no direct connection to a load.

EOPC-100 BUTTON LOCATIONS

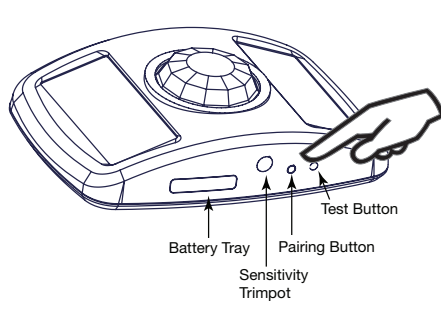

- The wireless receivers receive signals from the Occupancy Sensor (EOPC) via radio frequency once they are paired to the occupancy sensor.
 - The EOPC-100 uses radio frequencies to transmit signals to the wireless system.
- Note:** It is recommended that pairing of devices be done prior to installing ceiling sensor.



IMPORTANT NOTE: THE MAXIMUM NUMBER OF OCCUPANCY SENSORS (EOPC-100) AND WALL SWITCHES (EOSW-1XX) THAT CAN BE PAIRED TOGETHER IS TEN. WHEN THE MAXIMUM NUMBER OF DEVICES HAVE REACHED THE LIMIT, THE GREEN PAIRING "P" LED WILL FLASH RAPIDLY TO INDICATE THAT IT IS FULL.

PAIRING OF SENSOR TO RECEIVERS

*It is recommended that pairing of devices be done prior to installing ceiling sensor.

Step 1: Enter Pairing Mode

Press and Hold "Pairing" Button "P" on Receiver for 3 seconds then release:

- "Pairing" LED blinks 2 times/second to confirm pairing mode

For EOSW-101/EOSW-111

- Load 1 turns ON and is ready to be paired

For EOSW-102/EOSW-112

- Load 1 & 2 turn ON and are ready to be paired
- Button 1 & 2 LED are Solid ON

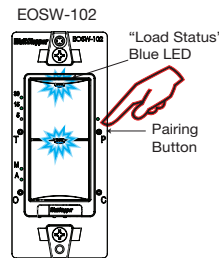
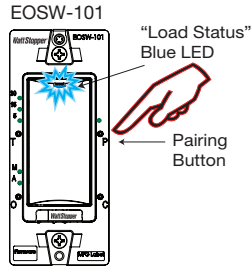

Step 2: Selecting a Specific Load to Pair (EOSW-102/EOSW-112)

*By default, both loads turn On at the same time in Pairing Mode. If both loads are to be controlled by Occupancy Sensor than skip this step.

Tap the "Pairing" Button "P" once while in pairing mode:

- Load 2 turns OFF and Load 1 remains ON
- Load 1 is now active and ready to be paired to selected transmitters
- Load 1 LED is Solid ON

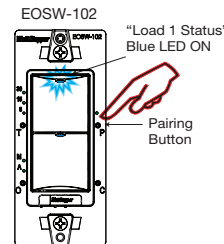

Tap the "Pairing" Button "P" once again while in pairing mode:

- Load 1 turns OFF and Load 2 turns ON
- Load 2 is now active and ready to be paired to selected transmitters
- Load 2 LED is Solid ON

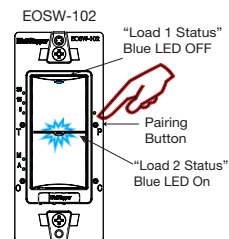

Tap the "Pairing" Button "P" a third time while in pairing mode:

- Load 1 and Load 2 turn ON again, indicating both loads are ready to be paired.

Step 3: Pair Occupancy Sensor to Receiver

* While the receiver is in pairing mode and the load you want to pair the sensor with is ON:

Tap the "Pair" Button on the Occupancy Sensor

- The selected load(s) will flash OFF/ON for visual pairing confirmation

EOPC-100 BUTTON LOCATIONS

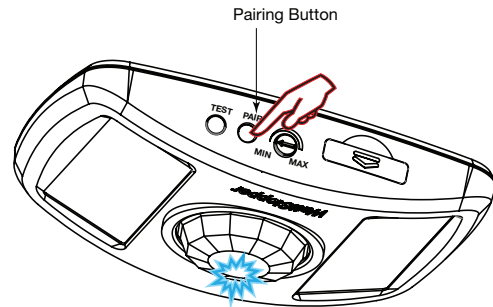

IMPORTANT NOTE: YOU WILL HAVE ONLY 30 SECONDS TO COMPLETE THE PAIRING MODE OPERATION

Step 4: Exit "Pairing" Mode on Receiver

Once a device is paired with the receiver the receiver will automatically exit "pairing" mode.

- The receiver will also exit "pairing" mode if no device is paired to it within 30 seconds.
- Pressing and holding the "Pairing" button "P" for 3 seconds also exits the pairing process.

Note: To pair additional devices to the same load, repeat Step 1 to re-enter "Pairing" mode.

Step 5: Verify Occupancy Sensor is "Paired" with the Receiver(s)

Tap the "Pairing" button "P" on the EOPC-100 while in normal operating mode.

- The load(s) will turn OFF, and will turn ON immediately (and remain On) if motion is detected.

TO "UN-PAIR" ALL CONNECTED DEVICES

Press and hold the Pairing button "P" on the receiver for about 10 seconds. The green LEDs will flash 3 times indicating un-pairing has occurred.

TESTING THE OCCUPANCY SENSOR

"Test" mode allows you to perform a sensor walk test to define the coverage area, optimum sensitivity settings, and product placement.

* WattStopper recommends you use a battery to perform test mode otherwise the sensor may not have enough power. A Lithium battery CR2032 or equivalent are recommended for use with the EOPC-100 sensor.

In "Test" mode, the sensor turns OFF all loads of receivers within range after 5 seconds of no detection and begins a 10 minute test period.

Step 1: To Enter Test Mode

Tap the "Test" button on the Occupancy Sensor

- The corresponding Time Delay LED on the EOSW receiver(s) blinks to confirm time delay selection for receiver(s) paired with the sensor that is in "Test" mode. The LED at "15" over the Time Delay "T" is to indicate the wall switches are in test mode with the occupancy sensor EOPC-100.

- The LED stops blinking once the sensor exits test mode, or by pressing and releasing the "Test" button on the EOPC-100 at any time during the test mode.

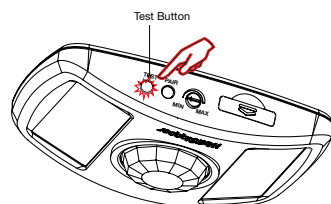

- When the sensor doesn't detect motion, all loads controlled by the sensor will turn OFF after 5 seconds of operation.

Step 2: Exit "Test" Mode

- The sensor will automatically exit test mode after 10 minutes and each load will either go back to the user defined set value or back to their selected time delay default value (i.e. Load 1 = 15 minutes, Load 2 = 30 minutes.)

Note: The 10 minute window is more than likely to require that the sensor be fully charged or use the battery. To manually exit "Test" mode to bypass the 10 minute window and reset it back to normal operation:

Tap the "Test" button on the Occupancy Sensor again

- The sensor exits test mode and the EOSW receiver LED stops blinking.

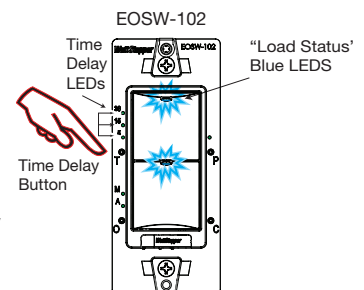

SENSOR MOUNTING

Mounting to junction box with mounting plate:

The EOPC-100 can be mounted to a pre-installed junction box using the mounting plate that is provided. The mounting plate works on single or double gang J-boxes.

1. Attach mounting plate to junction box with the provided screws.
2. Snap the sensor onto the mounting plate using the threaded screw.

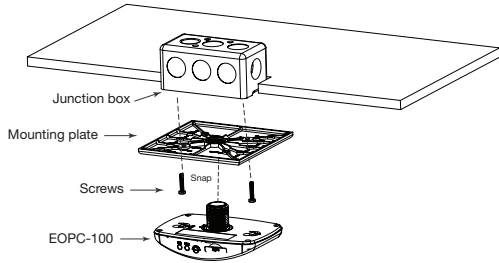

Mounting directly to junction box:

The EOPC-100 can also be mounted directly to a junction box using the provided screws.

1. Use two machine screws (included with the J-Box) to attach the sensor to the mounting tabs on the J-Box.
2. Align the sensor in the J-Box so that the mounting screw tabs on the J-Box match the key holes on the sensor's rear housing.
4. Slide sensor onto the junction box.

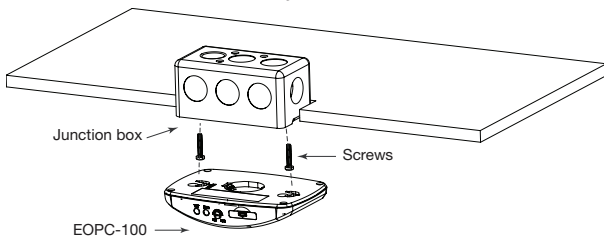

WARNING: Do Not Install To Cover a Junction Box Having Class 1, 3 or Power and Lighting Circuits.

Mounting to wood or non metal surfaces

The EOPC-100 can be mounted to any flat surface, or placed directly on the surface using the reversible mounting disc provided. One side of the disc is backed with foam tape for mounting to non-metal surfaces; the reverse side provides a super-magnet for mounting to metal.

1. Use the pull tab to release the mounting disc.
2. Snap the mounting disc into insert on back of sensor, tape end face up.
3. Attach the sensor to the desired location with the tape.

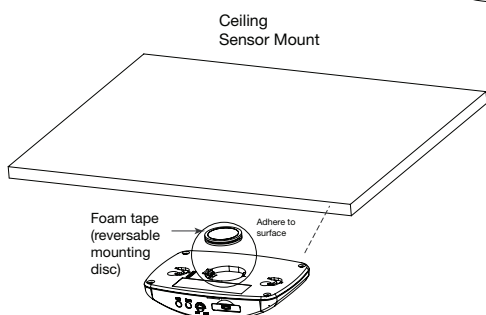
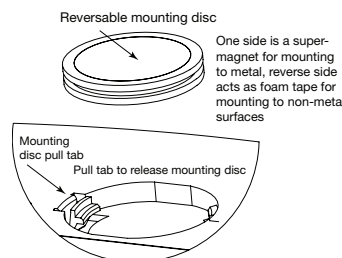

Through ceiling tile:

The EOPC-100 can be mounted through the ceiling tile using the mounting plate that is provided.

1. Attach mounting plate to ceiling tile as shown.
2. Drill hole in ceiling.
3. Line up threaded screw with hole in ceiling tile.
4. Snap the sensor onto the mounting plate through the hole in ceiling tile using the threaded screw.

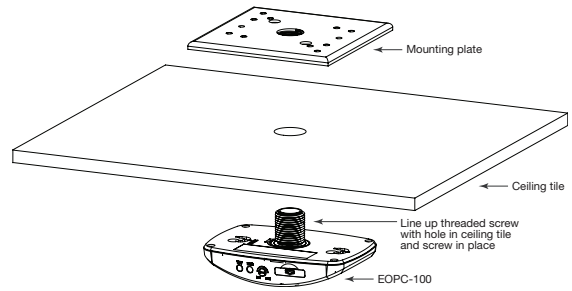

Mounting to solid wall:

The EOPC-100 can be mounted to a solid wall using the paper template that is provided.

1. Use the paper template to mark the surface of the wall with appropriate hole spacings.
2. Drill holes in wall.
3. Use two machine screws (included) to mount the EOPC-100 to the surface. Line up screws to markings on surface.
4. Align the sensor so that the mounting screws on the wall match the key holes on the sensor's rear housing and secure.

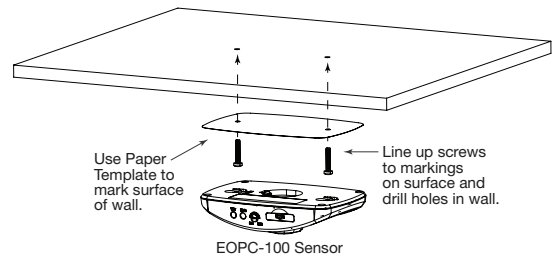

Mounting to metal surfaces

Use the super-magnet on the reversible mounting disc (included) to mount to any metal surface such as fixtures or metal desks.

1. Use the pull tab to release the mounting disc.
2. Snap the mounting disc onto insert on back of sensor, magnet end face up.
3. Simply snap the sensor onto the surface.

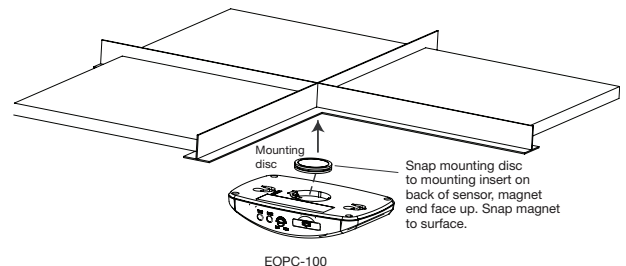

TROUBLESHOOTING

Does the system work more reliably at close range (without obstructions)?

Consider Factors Affecting the Environment:

In an indoor environment, the wireless controls have a typical range of 30-150 feet. If there are obstructions and/or noise interference the range will be less than the typical range.

Obstructions:

The range can be reduced by metal objects (metal decreases the effectiveness of RF transmission).

- Identify nearby metal, concrete and other objects possibly affecting signal strength
- If possible, try relocating the device (even slightly) away from obstructions to improve the system performance.

Does the system work better at certain times of the day?

- Look for pieces of equipment that may affect wireless performance when they are ON
- Noise interference can be either line noise (from motors) or Radio Frequency (RF)

Sensor does not learn:

- Please charge for 10 minutes in indoor light or sunlight before attempting to use, or insert optional battery

Sensor does not communicate to receiver:

- Check pairing of the sensor after install and commissioning, press test button to test the range (WITH A CHARGED SENSOR) if the load toggles, the range is good. If the load does not toggle, pull the sensor off the ceiling, verify charge by seeing the LED on the SENSOR flash, then press test button to test with the device close to the receiver, if still no load toggle, the device is either not charged or has not been paired properly (or may have even been unlearned) (see pairing section above)

If device still doesn't respond:

- Make sure the sensor is paired to the receiver by placing the receiver into pairing mode then tapping once on the sensor's pairing button.
- If the above steps do not resolve the problem call technical support at: 800.879.8585.

WARRANTY INFORMATION

WattStopper warranties its products to be free of defects in materials and workmanship for a period of five (5) years. There are no obligations or liabilities on the part of WattStopper for consequential damages arising out of or in connection with the use or performance of this product or other indirect damages with respect to loss of property, revenue, or profit, or cost of removal, installation or reinstallation.

WattStopper®

2800 De La Cruz Blvd.
Santa Clara, CA 95050

Phone: 800.879.8585
www.wattstopper.com

11/2013
16585r1

Please Recycle 