

Catalog Number • Numéro de Catalogue • Número de Catálogo: LMBC-300

Country of Origin: Made in China • Pays d'origine: Fabriqué en Chine • País de origen: Hecho en China
 LMBC-300-U is BAA and TAA compliant (Product produced in the U.S.)

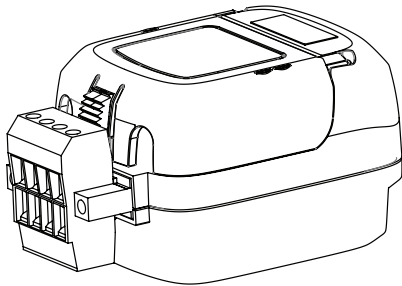

This unit is pre-set for Plug n' Go™ operation, adjustment is optional.

For full operational details, adjustment and more features of the product, see the DLM System Installation Guide provided with Wattstopper room controllers, and also available at www.legrand.us/wattstopper.

Installation shall be in accordance with all applicable regulations, local and NEC codes. Wire connections shall be rated suitable for the wire size (lead and building wiring) employed.

For Class 2 DLM devices and device wiring: To be connected to a Class 2 power source only. Do not reclassify and install as Class 1, or Power and Lighting Wiring.

SPECIFICATIONS

Voltage	24VDC
Current Consumption	36mA
Power Supply	Wattstopper Room Controller
Connection to the DLM Local Network.....	2 RJ-45 ports
Segment Network	
Conforms to BACnet MS/TP master communication protocol	
Baud rates (selectable)	38,400 default, 9,600; 19,200;
.....	57,600; 76,800 or 115,200
DLM Local Network characteristics when using LMRC-11x/2xx room controllers:	
Low voltage power provided over Cat 5e cable (LMRJ);	
max current 800mA. Supports up to 64 load addresses,	
48 communicating devices including up to 4 LMRC-10x series and/or LMPL-101 controllers.	
Free topology up to 1,000' max.	
Environment	For Indoor Use Only
Operating Temperature	32° to 158°F (0° to 70°C)
Storage Temperature	23° to 176°F (-5° to 80°C)
Relative Humidity	5 to 95% (non condensing)
Other:	
RoHS compliant	
UL2043 Plenum rated	
Patent Pending	

DESCRIPTION AND OPERATION

The LMBC-300 Network Bridge module provides a network connection for a group of Wattstopper Digital Lighting Management (DLM) Local Network room level devices. The DLM local network must include at least one LMRC-100 series or one LMRC-200 series room controller. Connecting the LMBC-300 to the DLM local network then to either the DLM Segment Manager or a third party system using the BACnet protocol exposes the status and parameters of all connected devices to the broader network.

MOUNTING AND INSTALLATION

Determine a suitable location for the LMBC-300. This will usually be in the plenum associated with the DLM local network devices you are adding to the broader network (although it may be convenient to locate in a more easily accessible space like a hallway outside a classroom). The LMBC-300 is UL2043 Plenum rated. A DIN rail mounting plate is provided with the LMBC for enclosure mounting if needed.

If code requires that the LMBC-300 be mounted in an enclosure, it can be mounted inside a 4" x 4" junction box, inside a 2 1/8" deep (or deeper) 2-gang wall box, in a 4" octagonal box, or on a 35mm DIN rail inside a building automation panel.

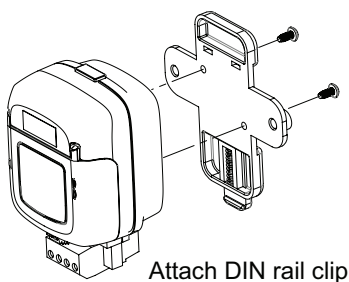

Attach DIN rail clip

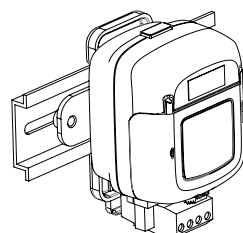

Option 1: Attach to DIN rail

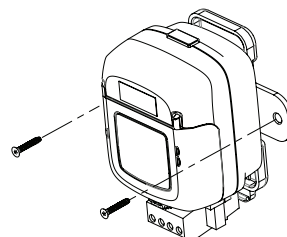

Option 2: Mount to wall

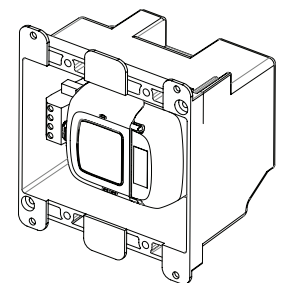

Inside a 2-gang J- box (no clip)

Attach the LMRJ Local Network Cable

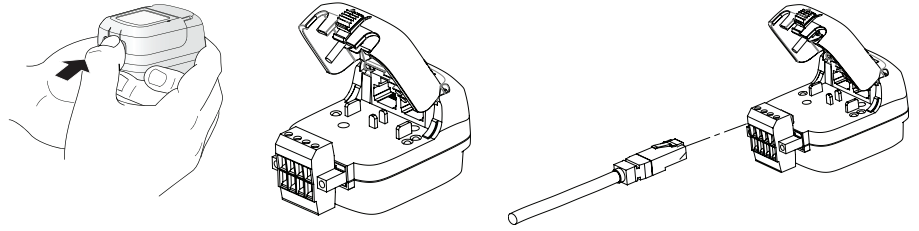

WIRING TO LOCAL NETWORK

The DLM local network uses free topology low voltage wiring. The LMBC-300 can connect anywhere on the DLM local network using LMRJ cables.

Use a Wattstopper LMRJ series cable or a Cat5e patch cable to connect the LMBC-300 to one of the RJ-45 jacks on any of the DLM local network devices. When connected to a powered DLM local network the red Transmit LED blinks rapidly. The red Config LED blinks at the same rate as the other DLM local network devices.

WARNING: Connect the LMBC-300 RJ-45 jack only to DLM lighting control devices. Do not connect Ethernet to the LMBC-300 RJ-45 jack.



CAUTION: TO CONNECT A COMPUTER TO THE DLM LOCAL NETWORK USE THE LMCI-100. NEVER CONNECT THE DLM LOCAL NETWORK TO AN ETHERNET PORT – IT MAY DAMAGE COMPUTERS AND OTHER CONNECTED EQUIPMENT.

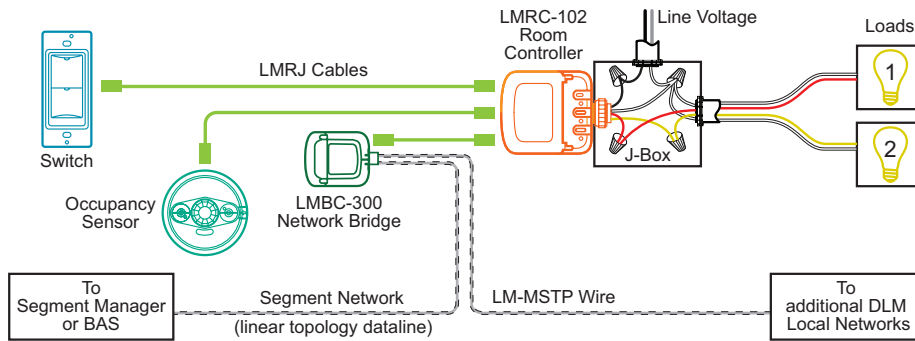

WIRING TO MS/TP NETWORK

1. Connect the MS/TP network wire to the Segment Network Terminals on the LMBC-300, observing positive (+) and negative (-) polarity.

When using Wattstopper LM-MSTP series wire, the positive is the white conductor, the negative is the black, and the reference is the green conductor.

Connect the incoming LM-MSTP wire's shield conductor to the outgoing LM-MSTP wire's shield conductor as shown on the next page. **DO NOT** connect shield to the LMBC's terminal block.

NOTE: The shield conductor should be connected to an earth ground at the Segment Manager or Router only. This means the "S" terminal is not normally used.

2. With the network terminals connected to an active network, both the red Transmit and green Receive MS/TP LEDs blink rapidly.

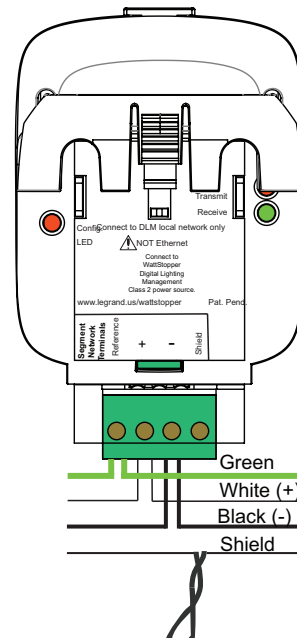

Connect Shield wires together. Do not connect to last (Shield) terminal.

WIRING INSTRUCTIONS - CONNECTING NETWORK BRIDGE TERMINALS TO THE SEGMENT NETWORK

- Strip back the outer jacket of the LM-MSTP wire about 3" and clip off both the foil wrapper and the string. Do NOT clip off the bare shield drain conductor.

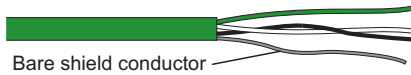

- Hold the two LM-MSTP wire ends together so that the jacket ends are even. Twist the bare shield drain conductors together and then wrap them around the two segment wires near the end of the jackets.

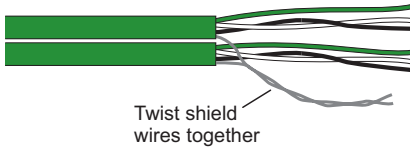

- Tape this connection down securing the two wires together in the process. Do NOT use wire nuts to secure the bare drain conductors.

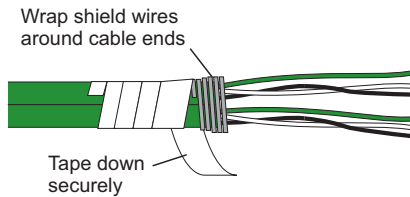

- Clip off the six insulated conductors to 1-1/2" long so that they are exactly the same length. Strip each conductor about 1/4", or just far enough to completely seat the connection in the terminal block.

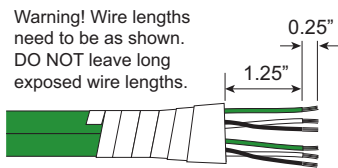

- Install the two black conductors into each of the "-" terminals. Install the white conductors into the each of "+" terminals. Install the green conductors into each of the "R" terminals. The DLM Segment Network connections to Network Bridges require exactly two wires in each terminal ("+", "-" and "R").

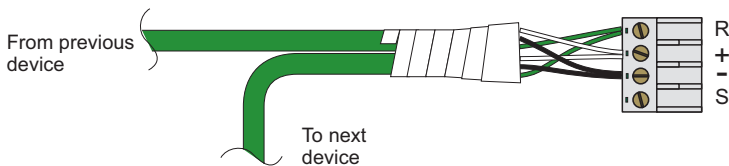

- Tug on the connections to make sure they are solid and inspect the terminal block to ensure that there are no loose strands of wire.

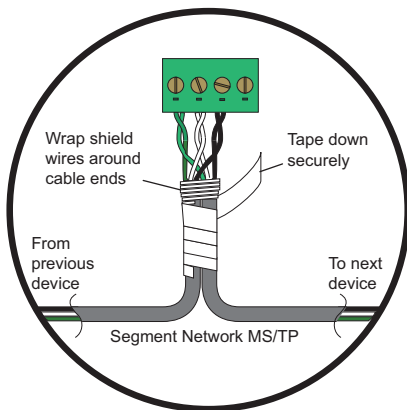

Termination Resistor

The last device on each end of a segment network MS/TP wire run must have a termination resistor. 120 ohm resistors are provided with the LMSM-201 and LMSM-603 for this purpose.

If the LMBC-300 is the last device on the MS/TP segment wire run, connect the resistor between the LMBC-300 positive (+) and negative (-) terminals along with the MS/TP wire connections.

When the LMBC-300 is the last DLM segment network device on the wire run, cap or tape the shield conductor to isolate it from ground or other contact.

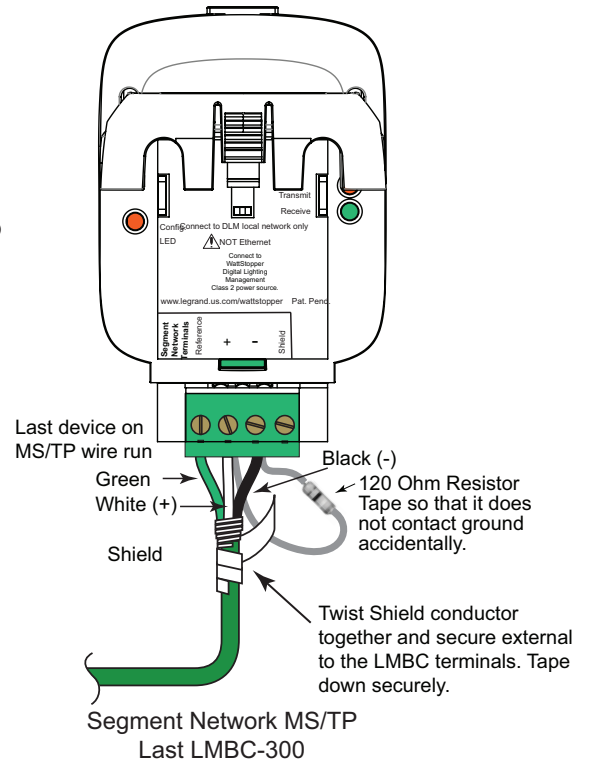
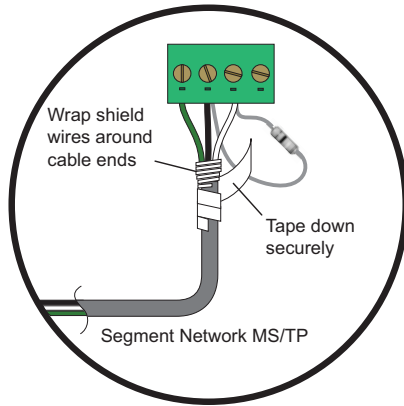

IF USING ON 2-WIRE MSTP NETWORKS

The LMBC-300 may be used on third party MSTP networks that do not employ a third wire reference conductor only if properly grounded. To ground the LMBC-300, connect a wire between the Reference terminal on the LMBC-300 to the nearest electrical system ground reference such as a junction box.

WARRANTY INFORMATION

Wattstopper warrants its products to be free of defects in materials and workmanship for a period of five (5) years. There are no obligations or liabilities on the part of Wattstopper for consequential damages arising out of, or in connection with, the use or performance of this product or other indirect damages with respect to loss of property, revenue or profit, or cost of removal, installation or reinstallation.

INFORMATIONS RELATIVES À LA GARANTIE

Wattstopper garantit que ses produits sont exempts de défauts de matériaux et de fabrication pour une période de cinq (5) ans. Wattstopper ne peut être tenu responsable de tout dommage consécutif causé par ou lié à l'utilisation ou à la performance de ce produit ou tout autre dommage indirect lié à la perte de propriété, de revenus, ou de profits, ou aux coûts d'enlèvement, d'installation ou de réinstallation.

INFORMACIÓN DE LA GARANTÍA

Wattstopper garantiza que sus productos están libres de defectos en materiales y mano de obra por un período de cinco (5) años. No existen obligaciones ni responsabilidades por parte de Wattstopper por daños consecuentes que se deriven o estén relacionados con el uso o el rendimiento de este producto u otros daños indirectos con respecto a la pérdida de propiedad, renta o ganancias, o al costo de extracción, instalación o reinstalación.