

Catalog Numbers • Les Numéros de Catalogue • Números de Catálogo: LMLS-500/LMLS-500-L

Country of Origin: Made in China • Pays d'origine: Fabriqué en Chine • País de origen: Hecho en China

Models ending in -U are BAA and TAA compliant (Product produced in the U.S.)

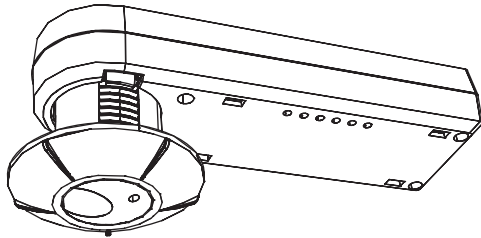

UNIT DESCRIPTION

The LMLS-500 is an open loop photosensor that measures daylight in order to automatically switch or dim up to three zones of lighting. It is part of a Digital Lighting Management (DLM) system and sends light level signals to control loads connected to DLM switching or dimming room controllers. The LMLS-500 has a photodiode with an extended range of 1-6,553 footcandles (fc) and photopic correction to mimic the human eye for precise measurement of visible light.

The LMLS-500 operates on Class 2 power supplied to a DLM local network by one or more DLM room controllers. Once set up, the LMLS-500 uses switching or dimming setpoints and other control parameters to manage the light levels throughout the day regardless of changing daylight contribution.

Sensor Installation and Configuration Overview

1. Mount the photosensor so that the Daylight Viewing Port directly views the daylight entering the space through a window or a skylight. See Placement Guidelines and Mounting the Photosensor.
2. Complete all wiring and turn ON power to the room controller.
3. Use the LMCS-100 or LMCT-100 configuration tool to complete the configuration process. The LMLS-500 will not operate properly until the configuration and calibration is successful.
 - a. Select the LMLS-500 to configure and select Zone Setup.
 - b. Choose the desired number of zones (1-3), then select the operating mode for each zone (Switched, Bi-Level, Tri-Level, Dimmed).
 - c. Assign individual loads to each of the configured zones.
 - d. Calibrate the LMLS-500. Use a light meter to measure the light level at each zone with the lights ON and OFF to determine the relationship between the light level at the task and light level at the LMLS-500.
 - e. Adjust Zone Settings and Advanced Settings to meet specific sequence of operation requirements.
 - f. Use Test Mode to verify the LMLS-500 operation.

SPECIFICATIONS

Light sensor range.....	1 to 6,553 fc
Voltage	24VDC
Current Consumption	max 13mA, typical 3mA
Power Supply	Wattstopper Room Controllers
Connection to the DLM Local Network.....	1 RJ45 port
Environment:	
Operating Temperature	32° to 131°F (0° to 55°C)
Storage Temperature	23° to 140°F (-5° to 60°C)
Relative Humidity	5 to 95% (non condensing)
Other:	
RoHS compliant, 5-year warranty	
Dimensions:	
LMLS-500/500-L	
Length.....	3.9" (99mm)
Width	1.2" (30mm)
Depth	Minimum 1.0" (25mm)
	Maximum 1.5" (38mm)
Tube Diameter.....	0.88" (22mm)
Ceiling Tile Thickness:	
LMLS-500	0"- 5/8" (16mm)
LMLS-500-L.....	5/8" (16mm) - 1.25" (31mm)

Factory Defaults

Switching Operation:	
ON Setpoint*	35 fc
OFF Setpoint*	53 fc
ON Time Delay.....	20 sec
OFF Time Delay.....	10 min
Dimming Operation:	
Setpoint*.....	50 fc
Ramp Rate Up	20% per sec
Ramp Rate Down.....	2% per sec
Cut Off Delay.....	Never
Advanced Parameters:	
Allow Override.....	No
Override Time.....	Infinity
Hold Off	No
Scenes Stop Daylighting.....	No
Ignore After Hours.....	No

* Setpoints change automatically upon calibration

PLACEMENT GUIDELINES



WARNING: DO NOT USE THE DLM LOCAL NETWORK TO CONTROL LOADS OTHER THAN LIGHTING IF THE LOAD IS NOT IN VIEW OF A PERSON AT ALL CONTROL LOCATIONS. DO NOT USE DLM TO CONTROL ANY LOAD THAT MIGHT BE DANGEROUS OR CAUSE A HAZARDOUS SITUATION IF ACCIDENTALLY ACTIVATED.

The LMLS-500 switches or dims electric light in response to daylight. It is important to select a location where the photosensor measures daylight contribution only. For proper operation the photosensor should not see any electric light contribution.

When the primary source of daylight is a window (sidelighting), the LMLS-500 is typically ceiling mounted between one to three feet away from the window. Figure 1a shows a typical placement location for a sidelit application. Figure 1b shows when the primary source of daylight is a skylight, mount the photosensor on the south of the light well with the lens facing north.

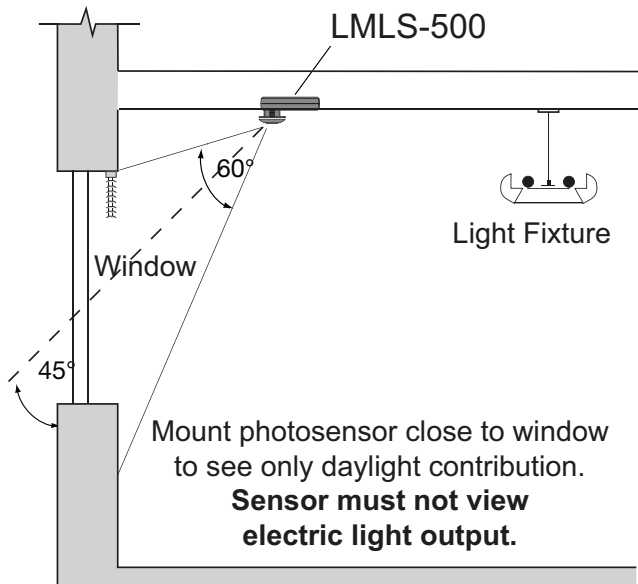

Fig. 1a: Ceiling Location

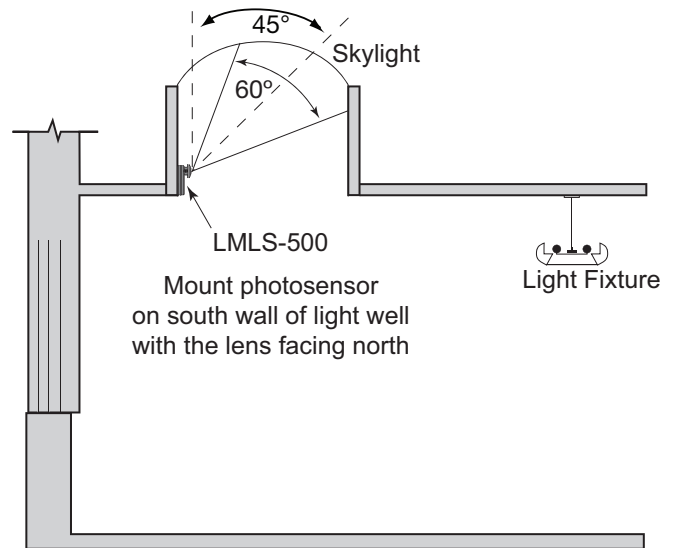

Fig. 1b: Skylight Location

IR COMMUNICATION

If the photosensor is mounted at ceiling heights greater than 20', communication with the photosensor must be through another IR-enabled DLM device such as an occupancy sensor or a wallswitch.

Infrared signalling can be affected by high ambient light such as direct sunlight, floodlights, and some halogen or fluorescent lamps, as well as plasma screens.

Be sure to point the remote at a DLM IR enabled device that is within range. To test, see if you can put the local network into PnL using the remote from your current position.

- If not successful, move closer to the IR enabled local network device and more directly in front of it, or try pointing toward a different IR enabled device.
- If still not successful, the IR lenses on the DLM devices may be dirty. Clean the lenses with a soft material such as an eyeglass lens cleaning cloth.

CONNECT THE LMRJ CABLE



WARNING: NEVER CONNECT THE DLM LOCAL NETWORK TO A COMPUTER'S ETHERNET PORT. NEVER CONNECT AN ETHERNET CABLE TO A DLM DEVICE – DLM IS NOT COMPATIBLE WITH ETHERNET.

The LMLS-500 receives power, and communicates with other DLM devices through a LMRJ cable that plugs into the RJ45 socket on the end of the unit.

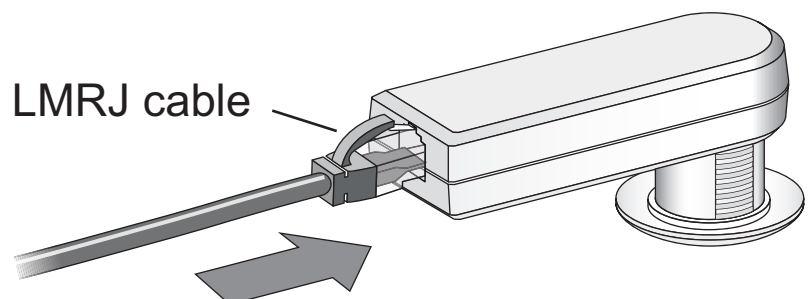

Fig. 2: Attaching the LMRJ Cable

MOUNTING THE PHOTOSENSOR

In most applications, the unit is mounted through a ceiling tile, with only the lens being visible from inside the room; the remainder of the unit rests on top of the tile. It can also be mounted on or through the wall of a skylight light well. In these types of applications, an accessory plastic mounting bracket is required. An accessory for mounting the unit to a J-Box is also available. The device has an adjustable head to accommodate multiple mounting methods and building materials or fixture walls up to 1.25" thickness.

Ceiling Mounted

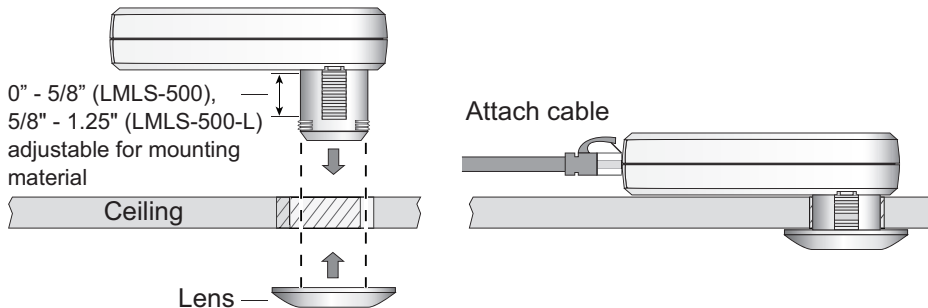

Fig 3: Mount Sensor to Ceiling

NOTE: For ceiling thickness lower than 5/8", the LMLS-500 must be used.

Skylight Wall Mounted

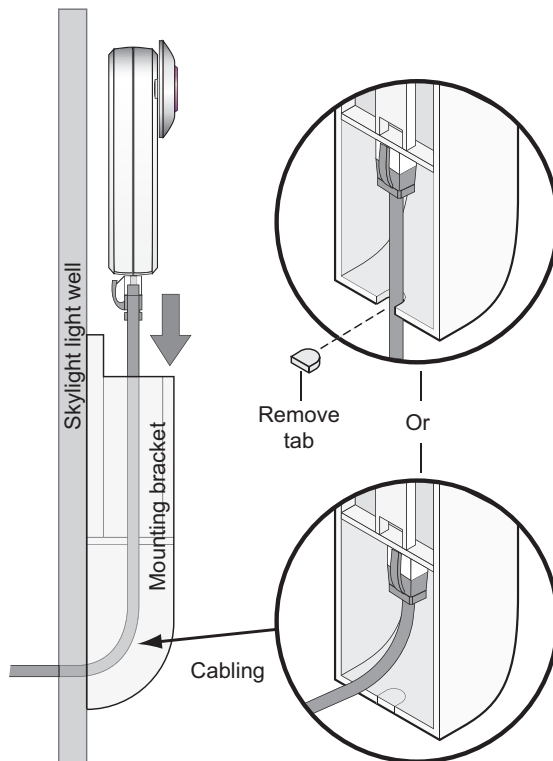

Fig 4a: Surface Mount using LMLS-MB2 Mounting Bracket

J-Box Mounted

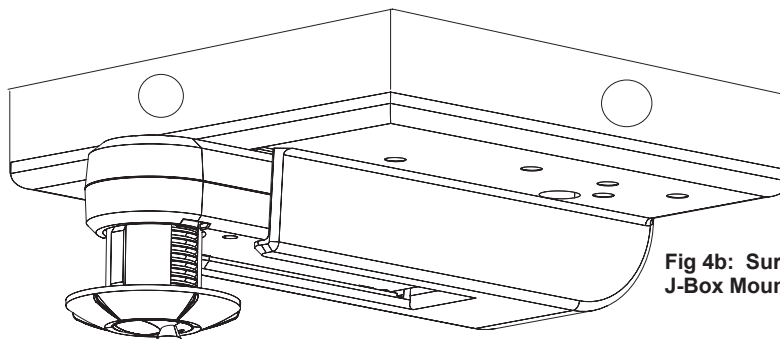

Fig 4b: Surface Mount using LMLS-MB1 J-Box Mounting Bracket

NOTE: For Skylight and J-Box mounting, the shorter-tube LMLS-500 model is recommended.

WIRING DIRECTIONS

Installation shall be in accordance with all applicable regulations, wiring practices, and codes.

The DLM Local Network is free topology low voltage wiring. The LMLS-500 can connect anywhere on the DLM Local Network. The following illustration is for example only.

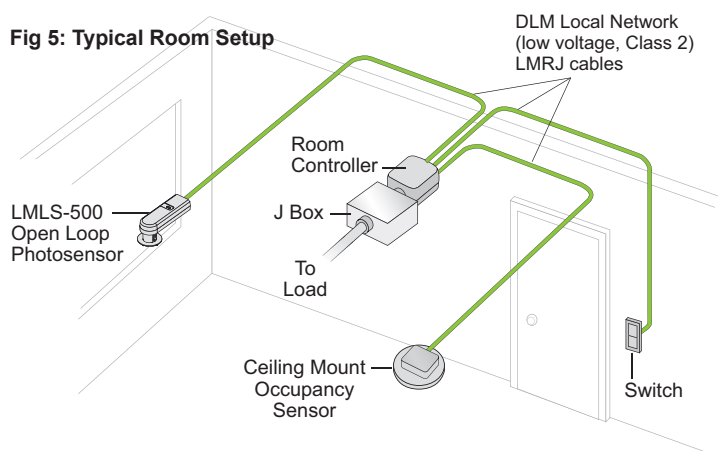

STATUS LEDs

Blue and red status LEDs are located in the sensor dome and are visible from all angles when lit or flashing.

Red LED

- Flicker for 0.5 sec. = IR message received
- Flashing = In PnL mode
- Flashing on 3 seconds, off for 1 second and repeat. Daylighting control is disabled.
- Solid = Sensor failure

Blue LED

- Flash once per second = Test or Demo mode
- Flash once per 4 seconds = Override mode
- Solid = Load binding test or PnL display

OPERATION

The LMLS-500 communicates to all other Lighting Management devices connected to the DLM Local Network. It is dependent on a DLM Room Controller (LMRC-100 series for ON/OFF switched loads, LMRC-200 and -300 series for ON/OFF switched loads and dimming capable loads). Options: A DLM Switch for override control, a DLM Occupancy Sensor for motion detection.

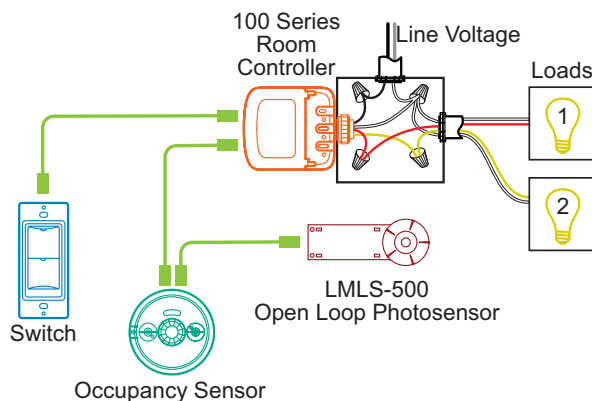

Fig. 6: DLM Local Network Example for Switched Loads

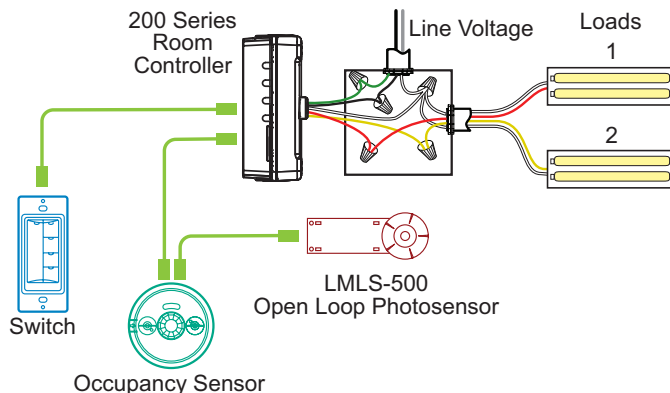

Fig. 7: DLM Local Network Example for Dimmed or Switched Loads

SENSOR PUSHBUTTONS

USER Button

- **Quick press** – cycle through load binding verification test
- **Press and hold for two seconds** – activate/deactivate test mode. Test mode automatically times out in 5 minutes.

CONFIG Button

- **Quick press** – if the system is not presently in PnL mode, the red LED will flash once. If the system is in PnL mode at the time of the press, the system will advance to select the next load on the IRB in sequence.
- **Press and hold for two seconds** – when the button has been held down for two seconds, the red LED will flash; releasing the button at this time will cause the system to enter PnL mode if it is not presently active (and the red LED will begin to flash slowly), or exit PnL mode if active (and cause the red LED to cease flashing).
- **Press and hold for 10 seconds** – when the button has been held down for ten seconds, the red LED will stop flashing and turn ON solid; releasing the button at this time will cause the LMLS-500 to clear its load bindings, but otherwise leave its internal parameters unmodified.
- **Press and hold for 20 seconds** – if the button is held down for twenty seconds or more, the red LED again starts to flash; releasing the button at this time will cause the device to completely reset to its factory defaults, and remove any configuration locks.

Fig. 8: USER Button

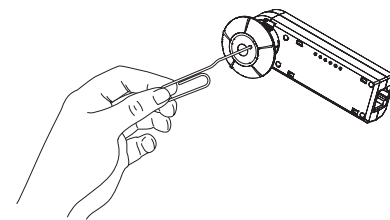
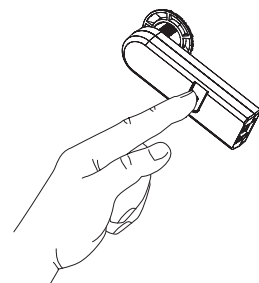

Fig. 9: CONFIG Button



OPERATING MODES

Plug n' Go

The LMLS-500, unlike most other DLM Components, will not auto-configure. The LMLS-500 must be manually configured using the LMCT-100 or LMCS-100.

Push n' Learn

Push and Learn™ (PnL) provides for remote load binding and configuration within the room, without requiring direct access to the Room Controller(s). While the LMLS-500 must be configured through the use of a configuration tool (e.g., LMCT-100), the CONFIG button at the back of the product can be used to force the system into or out of PnL, and/or to step to the next load in sequence.

Confirmation of Load Binding

To provide a confirmation of load bindings after installation, a quick press using a paper clip on the USER button sequences through three states:

1st press - all controlled loads forced ON at 100%

2nd press - all controlled loads forced OFF at 0%

3rd press - exit load binding confirmation mode and resume normal control. (Confirmation mode cancels automatically after 5 minutes if no further action is taken after the 1st or 2nd press.)

Test Mode

In Test Mode, time delays are reduced to 5 seconds (to create near-immediate reactions to changes in measured light levels), and the ramp rate increases to 20%/second (to cause the changes to be immediately visible).

To activate Test Mode, press and hold the USER button for 2 seconds or use a configuration tool. If not cancelled by the user, the controller automatically exits Test Mode after 5 minutes.

User Override of Levels Set by Daylighting Control

The electric light levels of loads configured for daylighting control can be adjusted from DLM wall switches, within limitations established by LMLS parameters that are set using the Advanced Settings screen of the LMCT-100.

The light level can always be reduced (by turning off loads in a switched zone, or by lowering the level of loads in a dimmed zone) without restriction. When a load is dimmed down from its daylighting-permitted level, the new level set becomes the maximum electric light level for that load (a "cap" level), regardless of daylight contribution, until the load is turned off and back on again, or until the level is adjusted upwards. If a load has been dimmed, a single tap on the top of a controlling switch's rocker will return the level to the maximum allowed by daylighting at that time, and cancel the level restriction ("cap") set by the earlier user adjustment.

Increasing the light level above that set by daylighting is possible only if **Allow Override** is set to **Yes** (the default is **No**). For switched modes, this means that the loads can be turned on even when the present ambient light level is above the On Setpoint. In the case of dimmed mode, a load will turn on and adjust to its daylighting-permitted level, but a subsequent tap on the top of a controlling switch will increase the level to maximum. In either mode, the affected loads will be temporarily removed from daylighting control, and be placed in an "override" state. The levels of the overridden loads can be changed or adjusted, and they will not return to daylighting control unless they are turned off and back on again (for example, by a cycle of occupancy).

If the **Override Time** parameter is changed from its default (**Infinity**) to a fixed time (e.g., 1 hour), all loads presently overridden will return to automatic daylighting control after the selected time period lapses.

Any loads not affected by the switch actions causing the override will continue to be controlled by daylighting; overrides occur on a load-by-load basis.

If any daylighting loads are presently overridden, the blue LED in the sensor head will flash once every four seconds.

To provide the ability to set arbitrary light levels in Dimmed applications, a switch with a dimming control rocker (e.g., LMDM-101 or LMSW-105) should be used.

Scene Control and Daylighting

Setting a new light level using a scene switch is possible, provided **Hold Off** is set to **No** (default). Such a light level change is not considered an override. If daylighting control is active when the new scene is selected, daylighting control suspends until the new scene is displayed, and then resumes, with the new light level established by the scene as the maximum electric light level ("cap" level), on a load-by-load basis, until a subsequent user action changes the level. Any daylighting loads not included in the scene will continue to operate as before the recall.

Optionally, daylighting control can be temporarily disabled for any loads on which a scene has been recalled. If **Scenes Stop DL** is set to **Yes**, daylighting control for a load affected by a scene will not resume until the level of the load is changed by another user action, or the load is turned off and on again.

CONFIGURATION

The configuration process establishes the appropriate parameters for operation. This is done through the use of an LMCT-100 configuration tool. If no configuration steps are taken, the sensor will use its default values for setpoints.

The LMCT-100 Wireless IR Configuration Tool is a handheld tool for setup and testing of Wattstopper Digital Lighting Management (DLM) devices. It provides wireless access to occupancy and daylighting sensors for setup and parameter changes, Wattstopper Push n' Learn™ (PnL) technology for load configuration, switch and dimmer assignment and operating parameter changes. The LMCT-100's display shows menus and prompts to lead you through each process. The navigation pad provides a familiar way to navigate through the customization fields. The LMCT-100 allows modification of the system without requiring ladders or tools; simply with a touch of a few buttons.

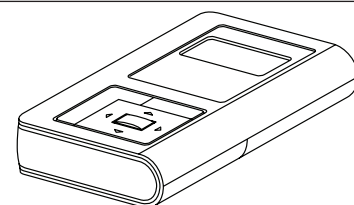

Fig. 10: LMCT-100

Operation

The LMCT-100's IR transceiver allows bi-directional communication between DLM devices and the LMCT-100. Simple menu screens let you see the current status of the system and make changes.

For systems including the LMLS-500 daylighting sensor the LMCT-100 can also set or change the daylight parameters. The LMCT-100 can change dimming system options such as scene assignments, ramp rates and other options not available through the standard user interface.

Batteries

The LMCT-100 operates on three standard 1.5V AAA Alkaline batteries or three rechargeable AAA NiMH batteries.

The battery status displays in the upper right corner of the display. Three bars next to BAT= indicates a full battery charge. A warning appears on the display when the battery level falls below a minimum acceptable level.

To conserve battery power, the LMCT-100 automatically shuts OFF 10 minutes after the last key press.

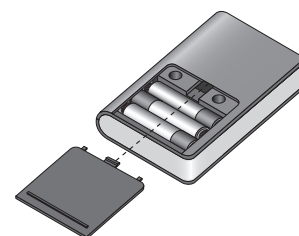

Fig. 11: Battery Location

Navigation

You navigate from one field to another using ▲ (up) or ▼ (down) arrow keys. The active field is indicated by flashing (alternates between yellow text on black background and black text on yellow background).

Once active, use the **Select** button to move to a menu or function within the active field.

Value fields are used to adjust parameter settings. They are shown in “less-than/greater-than” symbols: <value>. Once active, change them using ◀ (left) and ▶ (right) arrow keys. In general the ▶ key increments and the ◀ key decrements a value. Selections wrap-around if you continue to press the key beyond maximum or minimum values. Moving away from the value field (using ▲ / ▼ keys) overwrites the original value.

The Home button takes you to the main menu.

The Back button can be thought of as an undo function. It takes you back one screen. Changes that were in process prior to pressing the Back key are lost.

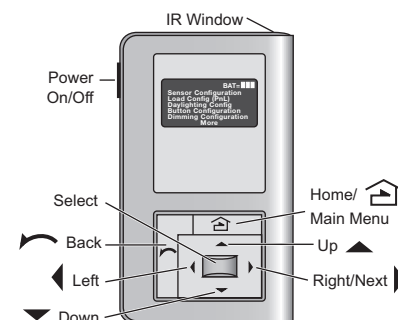
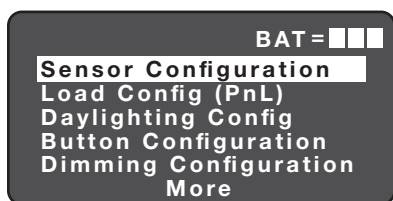
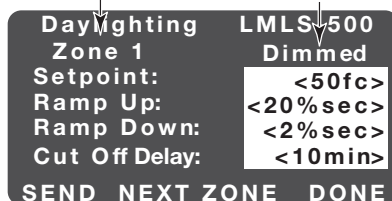

Fig. 12: LMCT-100 Controls

Function Fields (on Home Menu)



Parameters Value Fields



Press Left/Right arrow to select a value

Home Menu

The Home (or Main) menu displays after the power-up process completes. It contains information on the battery status and six menu choices.

Press ▲ / ▼ to locate the desired function then press **Select**.

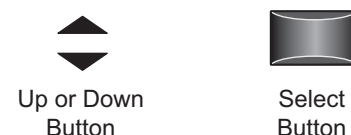
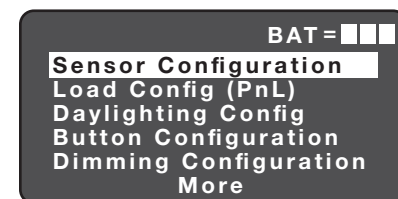

SPECIFIC PHOTOSENSOR

Daylighting LMLS-500

Specific Photosensor

Search Photosensors

Press Select

Point to the desired Photosensor and press 'Select'

Point and Press Select

LMLS-500 0293724909

Serial number will be different for each LMLS-500

Zone Setup

Calibration

Zone Settings

Advanced Settings

Control Mode

SEARCH PHOTOSENSOR

The Search Photosensor function allows you to identify which LMLS-500 will be commissioned. After enabling and pointing the LMCT-100 at any DLM device, a list of all LMLS-500s in the DLM Local Network appears on the screen. Each LMLS-500 has its own serial number.

Daylighting LMLS-500

Specific Photosensor

Search Photosensors

Choose Search Photosensors Press Select

Point to Any IR enabled device on the network

Press 'Select'

Point and Press Select

Daylighting LMLS-500

'Select' a device ID

0293724909

Choose Desired Photosensor Press Select

LMLS-500 0293724909

Serial number will be different for each LMLS-500

Zone Setup

Calibration

Zone Settings

Advanced Settings

Control Mode

LMLS-500 Daylighting Menu

LMLS-500 CONFIGURATON PROCESS

BAT =

Sensor Configuration

Load Config (PnL)

Daylighting Config

Button Configuration

Dimming Configuration

More

Choose Daylighting Config Press Select

Daylighting Config

LMLS-305/LS-301

LMLS-400

LMLS-500

LMLS-600

Choose LMLS-500 Press Select

ZONE SETUP

Selecting the Operation Mode

Zone Setup allows you to select the number of zones, change the operation mode of a zone, specify if a selected load is to be controlled by Daylighting and to bind loads to the LMLS-500.

LMLS-500 0293724909

Zone Setup

Calibration

Zone Settings

Advanced Settings

Control Mode

Press Select

Zone Setup LMLS-500

Number of Zones <3>

Choose the number of Daylighting Zones

CONTINUE

Press Left/Right arrow to select the number of Zones (1, 2, or 3)

Zone Setup LMLS-500

Number of Zones <3>

Choose the number of Daylighting Zones

CONTINUE

Choose CONTINUE Press Select

Point to Any IR enabled device on the network

Press 'Select'

Point and Press Select

Zone Setup LMLS-500

Zone 1: <Bi-Level>

Zone 2: <Switched>

Zone 3: <Tri-Level>

Pick a control type for ALL Zones

CONTINUE

Press Left/Right arrow to choose the desired operation mode for each Zone: <Switched>, <Bi-Level>, <Tri-Level> or <Dimmed>

Point to any IR enabled device on the Network

Press 'Select'

Point and Press Select

After choosing Zone Setup and pressing Select, the current operation mode is displayed. This can be changed to Switched, Bi-Level, Tri-Level, or Dimmed.

Switched

Switched mode provides ON/OFF switching within the daylighting zone controlled by the photosensor.

Load 1 - OFF 0%

Load 1 - ON 100%

Bi-Level

Bi-level mode provides three light levels within the daylighting zone controlled by the photosensor by using 2 load circuits.

Off = 0% Load 1 - OFF Load 2 - OFF

Med = 50% Load 1 - ON Load 2 - OFF

Max = 100% Load 1 - ON Load 2 - ON

ZONE SETUP (CONTINUED)

Tri-Level

Tri-level mode provides four light levels within the daylighting zone controlled by the photosensor by using 2 load circuits.

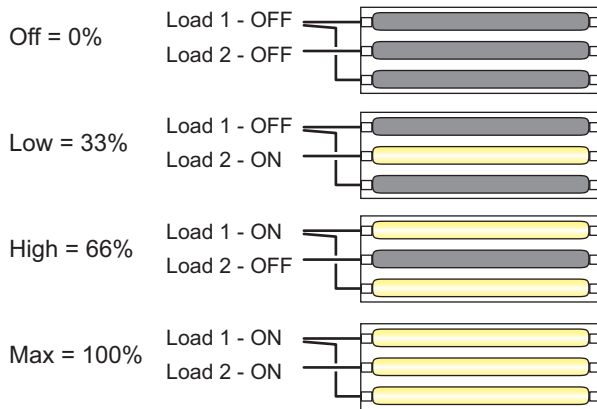

Dimmed

Dimmed mode provides continuous dimming within the daylight zone controlled by the photosensor.

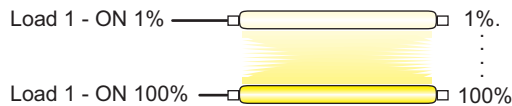

Load Assignments

To do load binding the load needs to be assigned.

Zone Setup LMLS-500
Bi-Level

Load: 1
Zone: <None>

NEXT PRIOR DONE

Zone Setup LMLS-500
Bi-Level

Load: 1
Daylight Load: <Yes>
ON When: <Max>

NEXT PRIOR DONE

Load 1: Press Left/Right arrow to select the Zone

If a Zone is selected, **ON When** appears after scrolling down.

Press Left/Right arrow to choose a specific value

For Bi-level and Tri-level only, press the Down arrow for On When to appear.

Zone Setup LMLS-500
Bi-Level

Load: 1
Zone: <1>
On When: <Med & Max>

NEXT PRIOR DONE

Zone Setup LMLS-500
Bi-Level

Load: 1
Zone: <1>
On When: <Med & Max>

NEXT PRIOR DONE

Bi-level and Tri-Level only:
Press the Down arrow for 'On When' to appear

Press Left/Right arrow:
For Bi-Level select Med & Max or Max
For Tri-Level select Low & Max or High & Max

Next

To continue to assign Daylight Load binding to load 2, choose NEXT.

Zone Setup LMLS-500
Bi-Level

Load: 1
Zone: <1>
On When: <Med & Max>

NEXT PRIOR DONE

Point to an IR enabled device on the Network

Press 'Select'

Choose NEXT Press Select

Point and Press Select

Zone Setup LMLS-500
Tri-Level

Load: 2
Zone: <2>
On When: <Low & Max>

NEXT PRIOR DONE

Zone settings for the next load is displayed.

Bi-level and Tri-Level only:
Press the Down arrow for 'On When' to appear

Press Left/Right arrow:
For Bi-Level select Med & Max or Max
For Tri-Level select Low & Max or High & Max

Prior

To continue to assign Daylight Load binding to the previous load, choose PRIOR. This function behaves the same for all Operation Modes.

Zone Setup LMLS-500
Bi-Level

Load: 1
Zone: <1>
On When: <Max>

NEXT PRIOR DONE

Point to an IR enabled device on the Network

Press 'Select'

Choose PRIOR Press Select

Point and Press Select

Done

When you have completed all load bindings, choose DONE. This function behaves the same for all Operation Modes.

Zone Setup LMLS-500
Switched

Load: 1
Zone: <1>

NEXT PRIOR DONE

Point to any IR enabled device on the Network

Press 'Select'

Choose DONE Press Select

Point and Press Select

LMLS-500 0293611935

Zone Setup
Calibration
Zone Settings
Advanced Settings
Control Mode

Zone Setup settings have been saved. The screen returns to the Daylighting Parameters menu.

Bi-Level Sequence of Operation (per zone)*

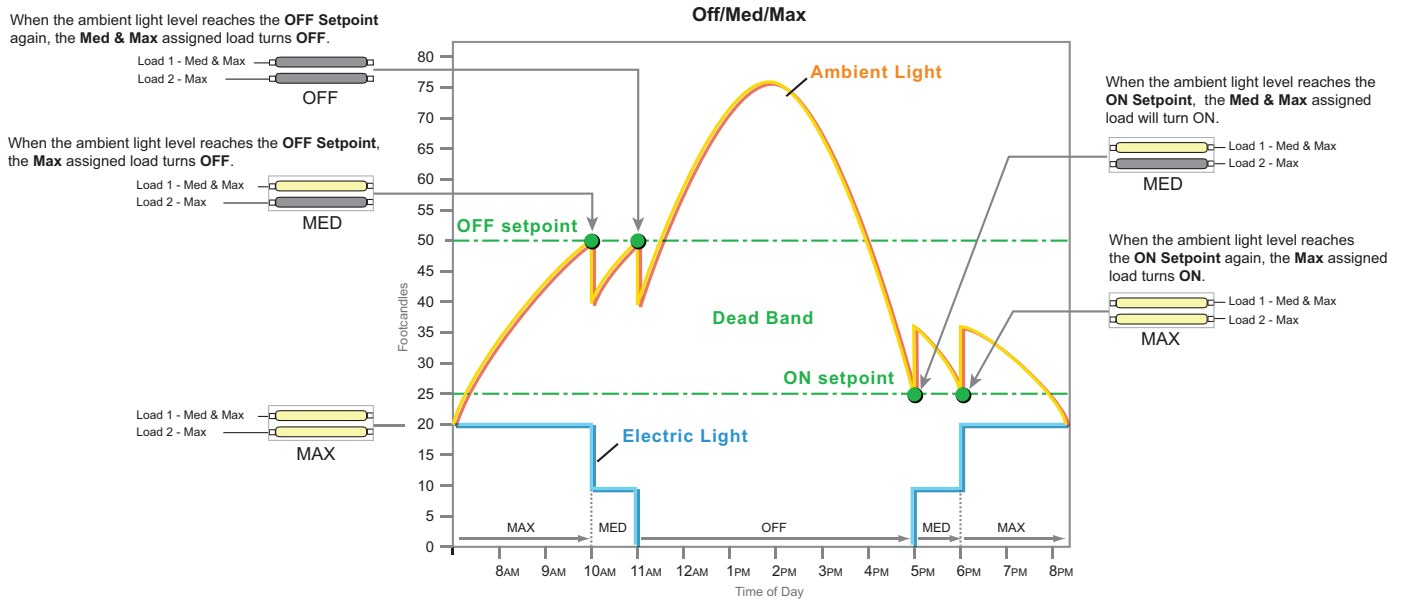

Tri-Level Sequence of Operation (per zone)*

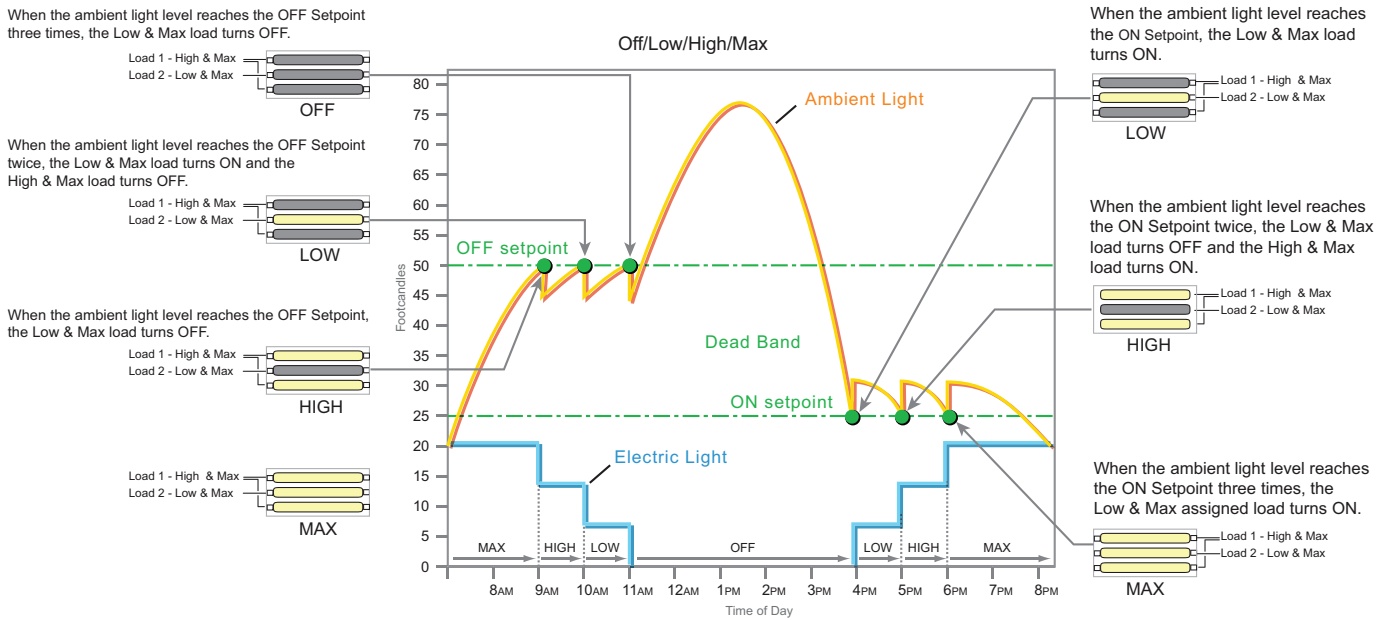

NOTE: This figure is intended to provide a visual interpretation of how the unit works. Actual ON/OFF setpoints will vary depending on light conditions.

CALIBRATION

Calibration allows you to establish a relationship between the workplane illuminance and the measured daylight at the photocell. Use the LMCT-100 for the Calibration process.

1. Complete all wiring and turn power ON to the connected room controllers.
2. Select the LMLS-500 to be calibrated using the LMCT-100.
3. Select Calibration. For each Zone, choose a reference location that is most likely to have the lowest light level when daylight for each zone.
4. With the electric lights ON, use a light meter to measure the light level in each zone.
5. Enter the measured light level at the task surface per zone, in the LMLCT-100.
6. Daylighting controlled loads will turn OFF.
7. Use a light meter to measure the light level in each zone.
8. Enter the measured light level at the task surface per zone in the LMCT-100.
9. Select the Send button to establish communication with the LMLS-500.

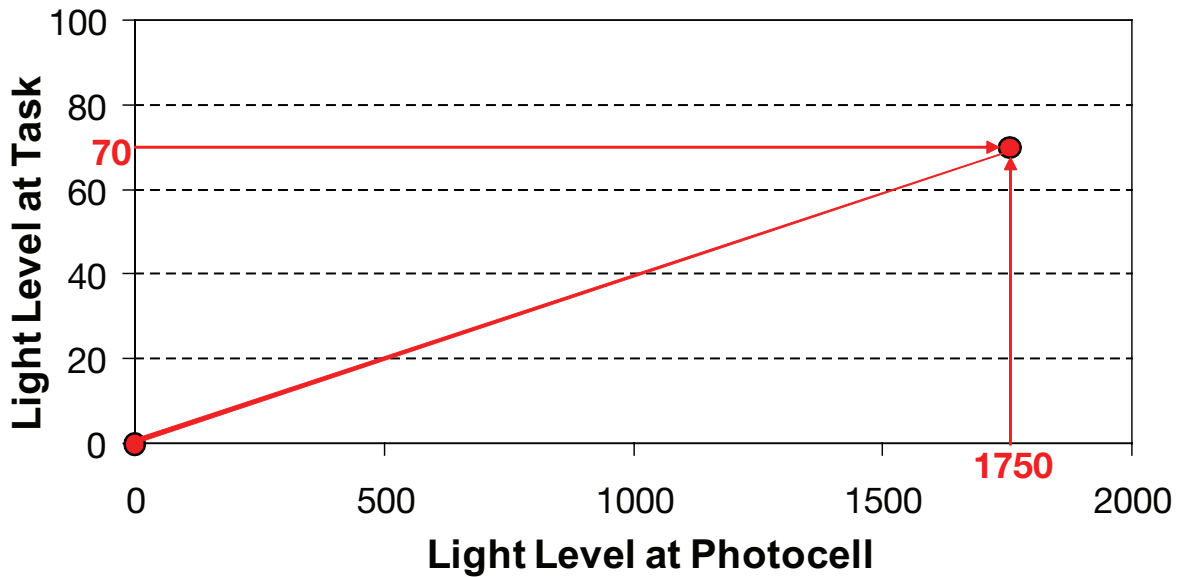

LMLS-500 0293724909

Zone Setup
Calibration
Zone Settings
Advanced Settings
Control Mode

Choose Calibration ▼ Press Select

Point to Any IR enabled device on the network

Press 'Select'

Point and Press Select

Calibrating LMLS-500

Lights will warm up and remain ON for two minutes

Please wait 120 sec.

Counts down from 120 seconds then returns to the Main Menu

Calibrating LMLS-500 (Full On)

Take a light level at Zone 1

Zone 1: 50fc

NEXT

Enter light level for ALL zones

Calibrating LMLS-500 (Full On)

Take a light level at Zone 1

Zone 3: 50fc

NEXT

Choose NEXT ▼ Press Select

ZONE SETTINGS

Zone Settings allows you to modify the photosensor Daylighting Setpoints, Time Delays and Ramp Rates.

When Zone Settings is selected, one of two screens is displayed depending on the Operation Mode of the Zone (Switched) or (Dimming, Bi-Level or Tri-Level):

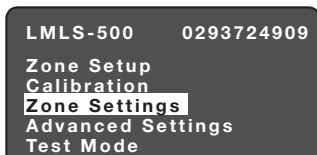

Choose Zone Settings ▼ Press Select

Send

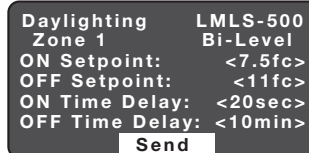

Press the Down Arrow ▼ to choose SEND



Point and Press Select

Switched, Bi-Level or Tri-Level

Dimmed

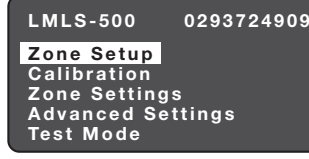
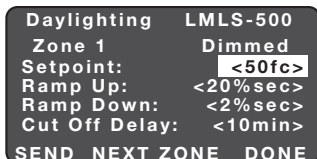
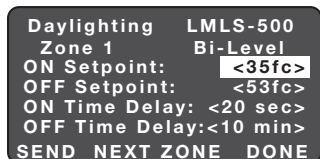

LMLS-500 Daylighting Menu

Zone Settings have been saved. The screen returns to the Daylighting Parameters menu.

Switched, Bi-Level, or Tri-Level

ON Setpoint

The target illuminance level below which the LMLS-500 turns the lights ON.

Range: 5 to 150 fc.

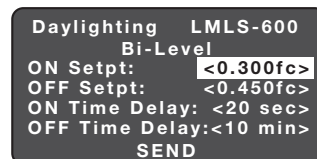

Press Left/Right arrow to raise or lower ON Setpoint footcandles

Dimmed

Setpoint

The desired light level at the task per zone. To determine the correct dimming level for any given photocell reading, it calculates the level based on the slope between the daylight contribution at the sensor and the setpoint.

Range: 5 to 200 fc.



OFF Setpoint

The target illuminance level above which the LMLS-500 turns the lights OFF.

The OFF Setpoint corresponds to the ON Setpoint multiplied by 1.25, 1.50, 1.75 or 2.0.

This ensures that the OFF Setpoint is always higher than the ON Setpoint.

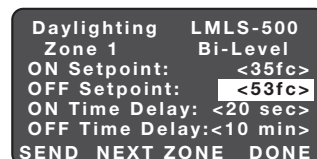

Press Left/Right arrow to raise or lower OFF Setpoint footcandles

Ramp Up

Determines the speed (or rate) at which the light level of bound loads increases. The default is 20% per second because the end user needs light quickly.

Range: 1% per second to 100% per second.



ON Time Delay

The time interval that must elapse, with the measured level below the ON Setpoint, before the controlled lights turn ON.

Range: 1 sec to 60 sec.

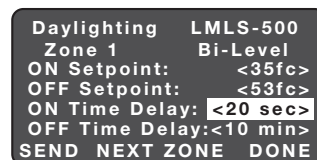

Press Left/Right arrow to raise or lower ON Time Delay <1sec - 60sec>

Ramp Down

Determines the speed (or rate) at which the light level of bound loads decreases. The default is 2% per second because a slow ramp down will help the eye adapt to the new light level.

Range: 1% per second to 100% per second.

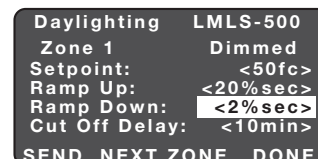

OFF Time Delay

The time interval that must elapse, with the measured level above the OFF Setpoint, before the controlled lights turn OFF.

Range: 3 min to 30 min.



Press Left/Right arrow to raise or lower OFF Time Delay <3min - 30min>

Cut Off Delay

The time that the controlled lighting will remain at a minimum dimmed level, even with high daylight contribution, before the lights will be switched OFF.

Range: Never to 30 min.

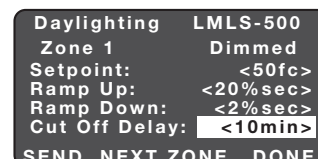

ZONE SETTINGS (CONTINUED)

Send

```

Daylighting  LMLS-500
Zone 1      Dimmed
Setpoint:   <50fc>
Ramp Up:    <20%sec>
Ramp Down:  <2%sec>
Cut Off Delay: <10min>
SEND NEXT ZONE DONE
    
```

Press the Down Arrow
to choose SEND 

```

Point to Any IR
enabled device on
the network

Press 'Select'
    
```

Point and
Press Select 

```

LMLS-500  0293725909
Zone Setup
Calibration
Zone Settings
Advanced Settings
Control Mode
    
```

Zone Settings have been saved.
The screen returns back to the
previous menu.

If Hold Off = <Yes>, the sensor will limit the loads to the level presently allowed by daylight contribution. This means that the loads may not initially turn ON (if the ambient light level is high - above the ON or Dimming Setpoint), but will become active for daylighting control, and will turn ON or dim up as daylight contribution drops.

Scenes Stop DL

When set to No the sensor adjusts levels, up to that recorded in the scene, even though a scene is active. When set to Yes, daylighting control is disabled for any loads on which a scene is recalled until a change is manually made to the level of the load, or until the next cycle of occupancy.

```

Daylighting  LMLS-500
Light Level:  300 fc
Allow Override: <Yes>
Override Time: <Infin>
Hold Off:     <No>
Scenes Stop DL: <No>
Ignore Aft Hrs: <No>
SEND NEXT
    
```

Ignore After Hours

When set to Yes, the photosensor will ignore After Hours and will continue to operate as normal.

When set to No, the daylighting controlled loads that are set to After Hours are removed from daylighting control for the duration of the After Hours period.

```

Daylighting  LMLS-500
Light Level:  300 fc
Allow Override: <Yes>
Override Time: <Infin>
Hold Off:     <No>
Scenes Stop DL: <No>
Ignore Aft Hrs: <No>
SEND NEXT
    
```

ADVANCED SETTINGS

Advanced settings allows you to see the light level at the photocell and to adjust the override mode and the override time delay.

```

LMLS-500  0293611935
Zone Setup
Calibration
Zone Settings
Advanced Settings
Control Mode
    
```

Choose  Press
Advanced Settings Select 

Light Level

Present light level measured at the LMLS-500.

```

Daylighting  LMLS-500
Light Level:  300 fc
Allow Override: <Yes>
Override Time: <Infin>
Hold Off:     <No>
Scenes Stop DL: <No>
Ignore After Hours: <No>
SEND NEXT
    
```

Send

```

Daylighting  LMLS-500
Light Level:  70 fc
Allow Override: <Yes>
Override Time: <Infin>
Hold Off:     <No>
Scenes Stop DL: <No>
Ignore Aft Hrs: <No>
SEND NEXT
    
```

Press the Down Arrow
to choose SEND 

```

Point to Any IR
enabled device on
the network

Press 'Select'
    
```

Point and
Press Select 

Allow Override

Determines if override mode is permitted, while daylighting control is active. Available choices: Yes or No

```

Daylighting  LMLS-500
Light Level:  300 fc
Allow Override: <Yes>
Override Time: <Infin>
Hold Off:     <No>
Scenes Stop DL: <No>
Ignore Aft Hrs: <No>
SEND NEXT
    
```

```

LMLS-500  0293724909
Zone Setup
Calibration
Zone Settings
Advanced Settings
Test Mode
    
```

Advanced Settings have been saved.
The screen returns to the Daylighting
Parameters menu.

Override Time

Override Time selects the time delay, after daylighting control has been disabled due to an observed external user or system action, before automatic control resumes. Range: Infinity or 1 to 24 hours.

```

Daylighting  LMLS-500
Light Level:  300 fc
Allow Override: <Yes>
Override Time: <Infin>
Hold Off:     <No>
Scenes Stop DL: <No>
Ignore Aft Hrs: <No>
SEND NEXT
    
```

Next

The Next parameter provides a screen that displays information about the daylight ratio and electric light contribution.

```

Daylighting  LMLS-500
Light Level:  70 fc
Allow Override: <Yes>
Override Time: <Infin>
Hold Off:     <No>
Scenes Stop DL: <No>
Ignore Aft Hrs: <No>
SEND NEXT
    
```

Choose NEXT
then Press 'Select' 

```

Daylighting  LMLS-500
DR Z1:  300 fc/  300 fc
DR Z2:  300 fc/  300 fc
DR Z3:  300 fc/  300 fc
EL Z1:  300.0 fc
EL Z2:  300.0 fc
EL Z3:  300.0 fc
PRIOR
    
```

Press 'Select' 
Selecting PRIOR will bring you
back to the previous screen.

Hold OFF

The Hold Off setting selects the behavior of daylighting loads when they are turned ON, by a switch or occupancy sensor. If Hold Off = <No> (default), the loads can always be turned on to their previous level, and then will begin to adjust based upon daylight.

```

Daylighting  LMLS-500
Light Level:  300 fc
Allow Override: <Yes>
Override Time: <Infin>
Hold Off:     <No>
Scenes Stop DL: <No>
Ignore Aft Hrs: <No>
SEND NEXT
    
```

```

Daylighting  LMLS-500
Light Level:  70 fc
Allow Override: <Yes>
Override Time: <Infin>
Hold Off:     <No>
Scenes Stop DL: <No>
Ignore Aft Hrs: <No>
SEND NEXT
    
```

DR = Daylight Ratio is the relationship between the daylight measured at the photocell versus the daylight per zone.
EL = Electric Light is the measured artificial light contribution per zone.

CONTROL MODE

Control Mode allows you to select the control status of the photosensor. After choosing Control Mode and pressing Select, point to the LMLS-500 and press Select. The current control mode is displayed. This can be changed to Normal, Test, Demo, or Disable.

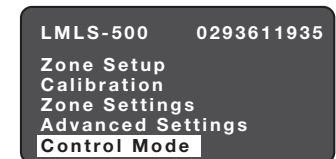

Choose Control Mode Press Select

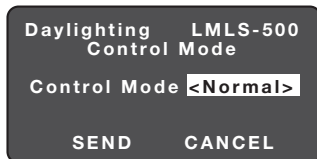

Press Left/Right arrow to scroll to the desired control mode <Normal> <Test> <Demo> or <Disable>

Press the left/right arrow to scroll through the options.

Normal:

Normal mode allows the photosensor to take control of the daylighting loads.

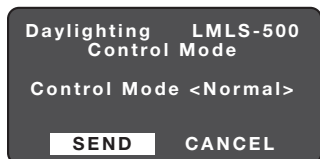

Press Left/Right arrow to choose <SEND> or <CANCEL>



Point and Press Select

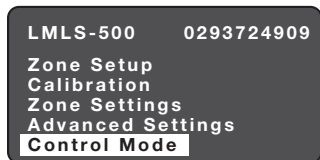

Control Mode has been saved. The screen returns to the Daylighting Parameters menu.

Test:

Test Mode shortens timeouts for switching operation, and speeds ramp rates for dimming operation, to allow quick verification. Test Mode cancels automatically after 5 minutes.

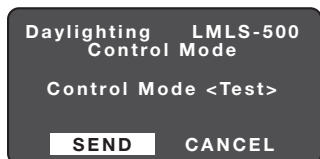

Press Left/Right arrow to choose <SEND> or <CANCEL>



Point and Press Select

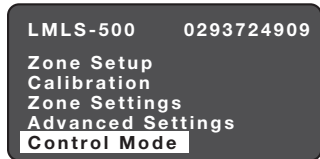

Control Mode has been saved. The screen returns to the Daylighting Parameters menu.

Demo:

Demo mode will allow the photosensor to select a set of preset parameters. This mode should only be selected when demonstrating the functionality of the unit is desired.

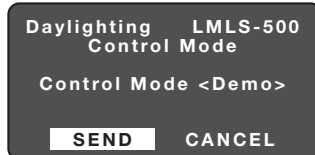

Press Left/Right arrow to choose <SEND> or <CANCEL>



Point and Press Select

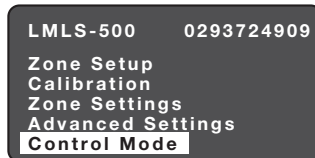

Control Mode has been saved. The screen returns to the Daylighting Parameters menu.

Disable:

Disable mode allows you to deactivate the LMLS-500 from the system. This parameter is mostly used for troubleshooting purposes.

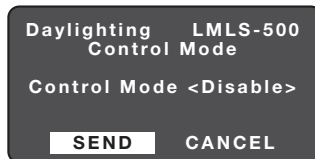

Press Left/Right arrow to choose <SEND> or <CANCEL>



Point and Press Select

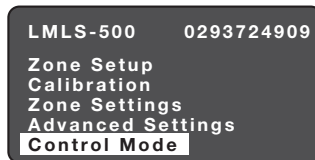

Control Mode has been saved. The screen returns to the Daylighting Parameters menu.

TROUBLESHOOTING

Lights do not switch or dim when desired, under daylight control

- Use the pushbutton on the photosensor face to manually test load control (see SENSOR PUSHBUTTONS on page 3). If the lights do not switch ON and OFF, check Zone Settings to rebind the loads. If the lights do switch ON and OFF, use the Zone Settings screen to verify that the ON and OFF setpoints are correct (if Switching / Bi-Level / Tri-Level), or if dimmed, dimming setpoint is correct. Place the photosensor in Test Mode to quickly verify daylighting operation; shine a flashlight into the sensor, or cover the sensor, to simulate major light level changes.
- The calibration may not be completed. To check calibration status, check the last screen in the Advanced Settings menu. If the electric light (EL) value is 0, perform the calibration process.

Red LED is ON, not flashing

- There is an internal failure in the LMLS-500 sensor. Try unplugging the sensor from the DLM network, then plug it back in and wait for ten seconds. If the red LED comes back on, and is not flashing, the sensor is defective and must be replaced.

Red LED is flashing ON for three seconds, OFF for one second (repeating)

- The LMLS sensor is in **Control Mode <Disable>**. Use the LMCT-100 to change the Control Mode parameter to **<Normal>** to resume daylighting operation.

Blue LED is flashing

- If the blink is slow (one flash every four seconds), the photosensor is in an override condition, either due to an override from a wall switch or due to manual commissioning operation. If the latter, complete the commissioning operation first; otherwise, use a wall switch to turn off the controlled loads to terminate the override.
- If the blink is faster (one flash every second), the photosensor is in Test Mode or Demo Mode. Test Mode will cancel automatically after five minutes. Alternatively, Test Mode or Demo Mode can be turned off by selecting the Control Mode menu from the LMLS-500 main screen in the LMCT-100.

Reset to Factory Defaults

- If the photosensor has been moved from a different location, or its internal parameters are unknown and an LMCT-100 is not immediately available, it can be reset to factory defaults by pressing and holding the CONFIG button for 20 seconds (see SENSOR PUSHBUTTONS on page 3).

WARRANTY INFORMATION

Wattstopper warrants its products to be free of defects in materials and workmanship for a period of five (5) years. There are no obligations or liabilities on the part of Wattstopper for consequential damages arising out of, or in connection with, the use or performance of this product or other indirect damages with respect to loss of property, revenue or profit, or cost of removal, installation or reinstallation.

INFORMATIONS RELATIVES À LA GARANTIE

Wattstopper garantit que ses produits sont exempts de défauts de matériaux et de fabrication pour une période de cinq (5) ans. Wattstopper ne peut être tenu responsable de tout dommage consécutif causé par ou lié à l'utilisation ou à la performance de ce produit ou tout autre dommage indirect lié à la perte de propriété, de revenus, ou de profits, ou aux coûts d'enlèvement, d'installation ou de réinstallation.

INFORMACIÓN DE LA GARANTÍA

Wattstopper garantiza que sus productos están libres de defectos en materiales y mano de obra por un período de cinco (5) años. No existen obligaciones ni responsabilidades por parte de Wattstopper por daños consecuentes que se deriven o estén relacionados con el uso o el rendimiento de este producto u otros daños indirectos con respecto a la pérdida de propiedad, renta o ganancias, o al costo de extracción, instalación o reinstalación.
