

SAFETY INSTRUCTION

IMPORTANT: NEVER attempt any work without shutting off the electricity.

- Always turn off power at fuse box prior to installation to prevent electrical shock.
- Intended for indoor use. Dry and damp locations.
- Install in accordance with national electric code, and local regulations.
- Consult with local inspector to assure compliance.
- Do not submerge, or install within 5 feet of a swimming pool.
- Do not connect the tape directly to high voltage power

CAUTION – TO REDUCE RISK OF FIRE AND ELECTRICAL SHOCK

- Read all instructions before installing.
- Handle product with care.
- Do not conceal or extend exposed conductors through a building wall
- To reduce the risk of fire and burns, do not install this lighting system where the exposed bare conductors can be shorted or contact any conductive materials
- To reduce the risk of overheating and potential fire risk, make sure all connections are tight.
- Do not install any fixture assembly closer than 6 in. from any curtain, or similar combustible material.
- Do not modify or disassemble product beyond instructions or warranty will be void.
- Failure to follow safety warnings, and installation instruction will void the warranty

ATTENTION - AFIN DE RÉDUIRE LES RISQUES D'INCENDIE ET DE CHOC ÉLECTRIQUE

- Lire toutes les instructions avant d'installer.
- Manipuler le produit avec soin.
- Ne pas dissimuler et faire passer les conducteurs exposés à travers un mur de bâtiment.
- Afin de réduire les risques d'incendie et de brûlures, ne pas installer ce système d'éclairage là où les conducteurs dénudés peuvent être court-circuités, ou entrer en contact avec des matériaux conducteurs.
- Afin de réduire le risque de surchauffe et d'incendie potentiel, s'assurer que toutes les connexions sont bien serrées.
- Ne pas installer aucun luminaire à moins de 6 pouces d'un rideau ou d'un matériau combustible similaire.
- Ne pas modifier ou démonter le produit au-delà des instructions sous peine d'annuler la garantie.
- Ne pas respecter les avertissements de sécurité et des instructions d'installation annulera la garantie.



Avoid contact with sharp objects



Install on stable clean, dry surface

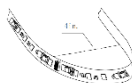

Do not bend the tape light to a diameter less than 4 inches

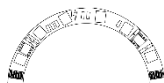

Do not bend the tape light on a horizontal plane



Do not cover LED tape light with any materials



Do not fold or twist LED Tape

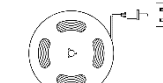

Do not power the LED tape while attached to the pool or tightly coiled

WIRING AND INSTALLATION:

1. Turn Power off at circuit breaker (See FIG. 1)

FIG. 1

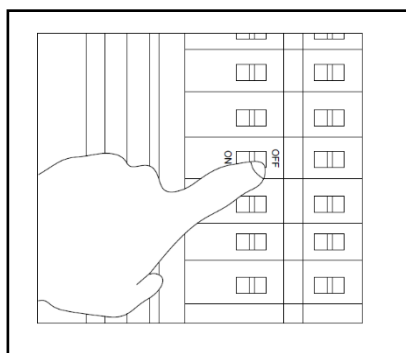

2. Mounting 24VDC Class 2 remote power supply and WAC Wireless DMX LED Controller at desired location. (See FIG. 2)

FIG. 2

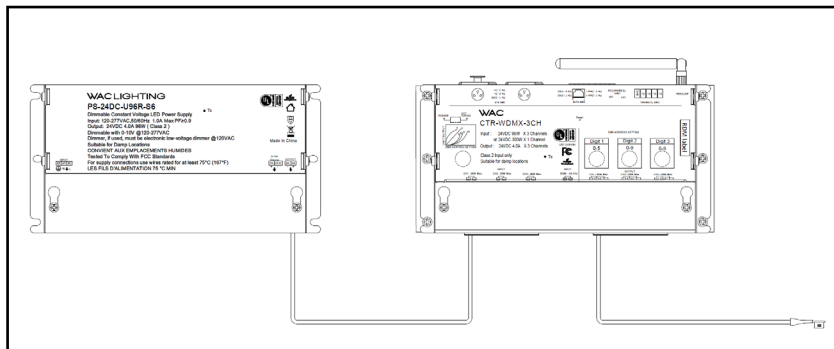

3. Measured a distance between power supply and DMX controller to the beginning of the tape run. Choose between two options below to wire the power and data communication to the tape. When choosing wire, factor in voltage drop, amperage rating, shield/unshielded, and type (in-wall rated).

Option A: Unshielded Cable 25 ft. maximum distance between power supply to the beginning of the tape

The WAC In wall rated 20 AWG unshielded cable can be used to wire between a power supply-Wireless DMX LED Controller to the beginning of the tape up to 25 ft. Smaller gauge wire number (bigger conductor) can be used, but the maximum run length limitation remains at 25 ft. due data communication distortion if it's run over 25 ft. (See FIG. 3) Wire color connection is shown in Table 1.

Table. 1

Wire Color Connection		
Wireless DMX LED Controller Terminal Color	T24-EX3-* Cable	Tape marking
RED	RED	+24VDC (RED)
WHITE	WHITE	DATA (WHITE)
BLACK	BLACK	- (BLACK)

FIG. 3

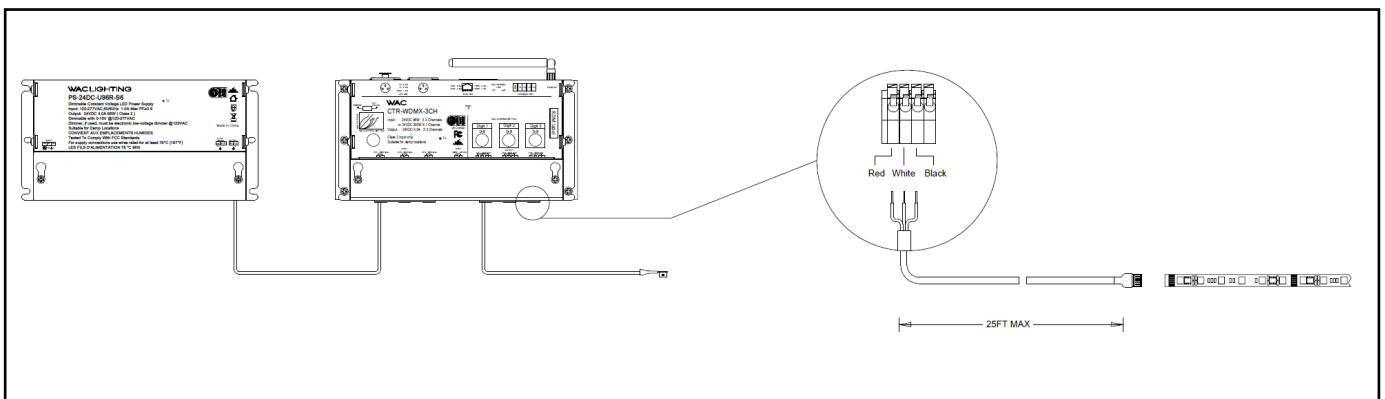

Option B: Shielded data Cable 90 ft. maximum distance between power supply to the beginning of the tape

A shield data cable shall be used to connect between the power supply-Wireless DMX LED Controller to the beginning of the tape up to 90 ft. (See FIG. 4)

ICE cable model number: Control Yellow is recommended. Product information can be found below:

<https://www.icecable.com/products/control-yellow>

https://icecable.s3.amazonaws.com/uber_products/specs/000/000/078/original/Control_Yellow.pdf?1435595602

For Plenum spaces, ICE cable Control Yellow Plenum is recommended. <https://www.icecable.com/products/control-yellow-plenum>

Both drain and common conductor wires shall be connected to a black terminal of Wireless DMX LED Controller. Another end shall be connected to the black wire of connector cable. The signal conductor shall be connected to the white terminal of Wireless DMX LED Controller. Another end shall be connected to the white wire of connector cable. The power carrying cable can be used either shielded or unshielded cable. The bigger conductor yields less voltage drop. The +24VDC polarity shall be connected to the red terminal on Wireless DMX LED Controller. Another end shall be connected to the red wire of connector cable. The -24VDC or common conductor wire shall be connected to a black terminal of Wireless DMX LED Controller. Another end shall be connected to the black wire of connector cable. (see FIG. 5)

T24-B-WT (5-3 terminal box) may be used to connect between 5 wires of shield cable to 3 wires of InvisiLED tape connector.

FIG. 4

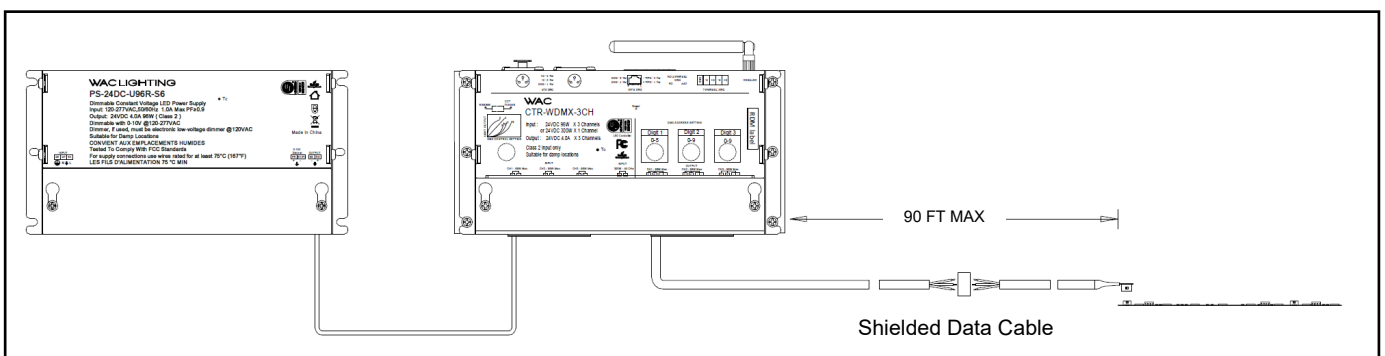
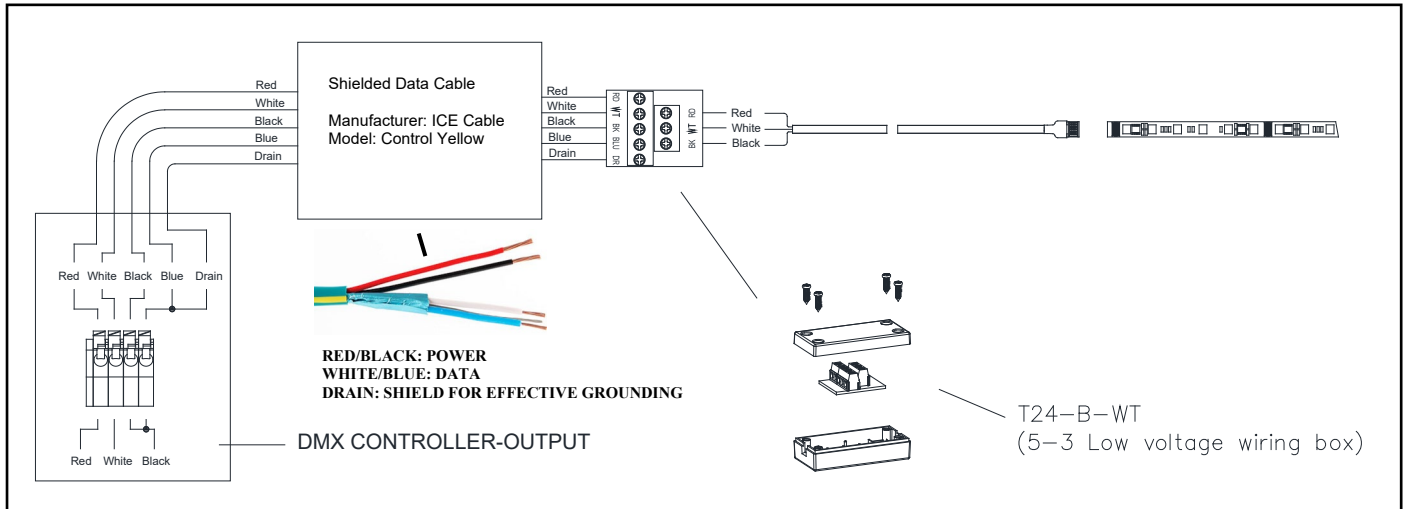
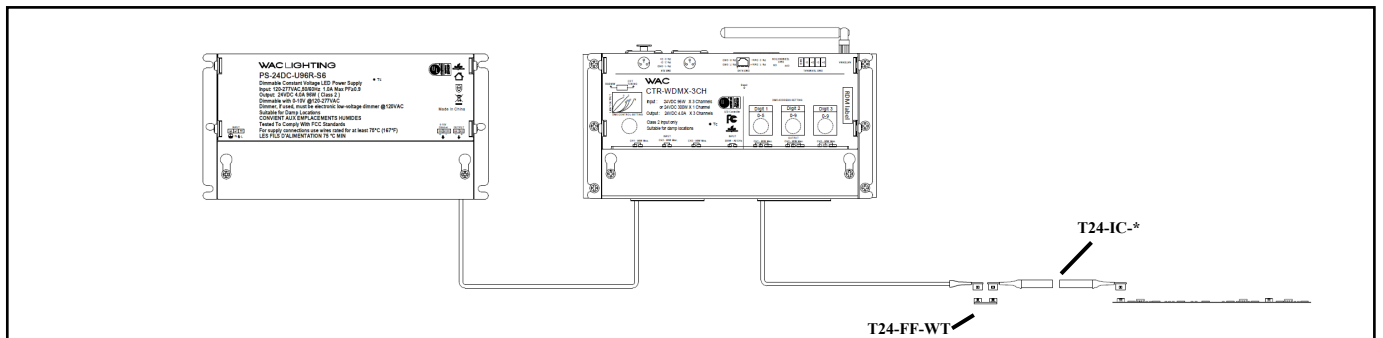

FIG. 5



To extend an unshielded cable length (if needed), In Wall Rated Joiner Cable (T24-IC-*) and Joiner Cable Extender (T24-FF-WT) can be used to join between sections as shown in FIG. 6

FIG. 6



- To extend the cable length between Wireless DMX LED Controller cable or a wiring box to a tape sections, (if needed), In Wall Rated Extension cable (T24-EX3-*) can be used to join between sections by soldering as shown in FIG. 7. Wire color connection is shown in the Table 1.

FIG. 7

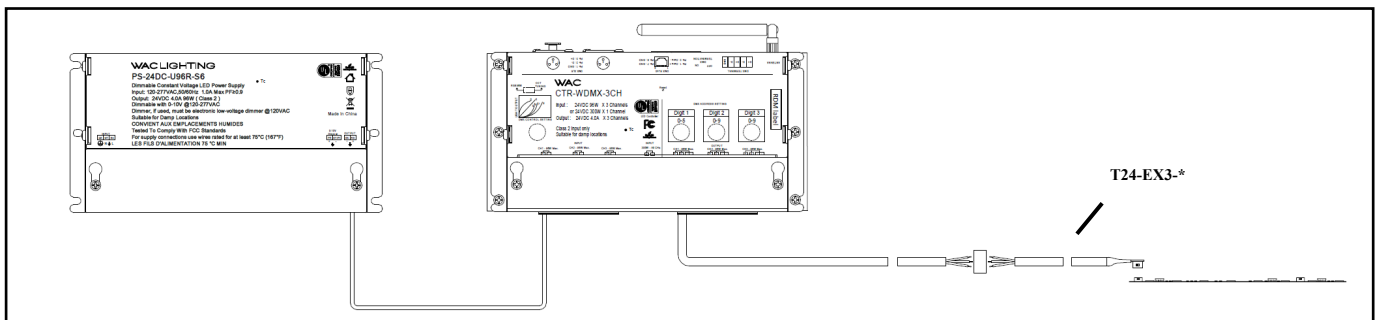

- Measure the desired length of tape light and round it off to the nearest 4-inch interval. Determine necessary quantities of other accessories and power supply need for each run. (See FIG. 8)

FIG. 8

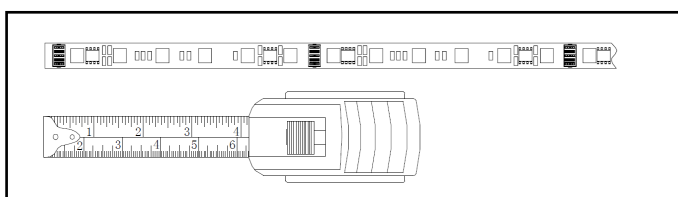

- Determine the maximum run according to specific color & CCT range as shown in reference Table 2. A lower light output can be adjusted by lowering DMX value in the same ratio to keep the same color or CCT.

Note: Setting the maximum DMX value at lower number will increase the maximum run length as the tape consume less power.

Table 2.

Color & CCT (K)	Current (A/ft)	Power (W/ft)	Max Run (ft)	Lumen	DMX Value						
					CH1: RED	CH2: GREEN	CH3: BLUE	CH4: 2700K	CH5: 5000K	CH6: R/G/W	CH7: 27/50
RGB (White)	0.1895	4.8	20	124	255	255	255	0	0	255	0
RED	0.0886	2.3	41	27	255	0	0	0	0	255	0
GREEN	0.0883	2.3	41	72	0	255	0	0	0	255	0
BLUE	0.0885	2.3	40	21	0	0	255	0	0	255	0
2700K	0.1276	3.2	30	156	0	0	0	255	0	0	255
2800K	0.1482	3.3	28	164	0	0	0	255	5	0	255
2900K	0.1614	3.5	27	183	0	0	0	255	20	0	255
3000K	0.1717	3.7	26	213	0	0	0	255	40	0	255
3100K	0.1792	3.9	24	212	0	0	0	255	60	0	255
3200K	0.1849	4.0	23	227	0	0	0	255	80	0	255
3300K	0.1912	4.2	22	244	0	0	0	255	105	0	255
3400K	0.199	4.5	21	265	0	0	0	255	140	0	255
3500K	0.2051	4.8	20	274	0	0	0	255	170	0	255
3600K	0.2118	5.0	19	309	0	0	0	255	210	0	255
3700K	0.2185	5.4	17	323	0	0	0	255	255	0	255
3800K	0.2108	5.2	18	308	0	0	0	205	255	0	255
3900K	0.2062	4.8	20	293	0	0	0	175	255	0	255
4000K	0.1992	4.5	21	273	0	0	0	140	255	0	255
4100K	0.1953	4.4	22	260	0	0	0	120	255	0	255
4200K	0.1904	4.2	22	250	0	0	0	100	255	0	255
4300K	0.1851	4.1	23	232	0	0	0	80	255	0	255
4400K	0.1806	4.0	24	223	0	0	0	65	255	0	255
4500K	0.1781	3.9	24	217	0	0	0	55	255	0	255
4600K	0.1724	3.8	25	209	0	0	0	40	255	0	255
4700K	0.17	3.7	26	202	0	0	0	35	255	0	255
4800K	0.1622	3.6	27	192	0	0	0	20	255	0	255
4900K	0.1583	3.5	27	189	0	0	0	15	255	0	255
5000K	0.1284	3.3	29	177	0	0	0	0	255	0	255

The RGBWW tape are comprised of two main color groups that yield different light results.

Group A: RGB (Red/Green/Blue)

RGB or any color mixing in between will maintain the light output as long as the tape voltage is higher than 20VDC. The light output (Lumens) starts to degrade as a tape voltage gets lower as shown in FIG. 10

Group B: WW (2700K & 5000K)

WW or any color mixing in between will maintain the light output as long as the tape voltage is higher than 21VDC. The light output (Lumens) starts to degrade as a tape voltage gets lower as shown in FIG. 10

The tape voltage can be checked using voltage meter probe to measure the DC voltage between soldering point of RED and BLACK on the tape as shown in FIG. 9

In order to maintain a voltage or having less voltage drop on the tape, bigger conductor wire or lower gauge wire number is recommended.

FIG. 9

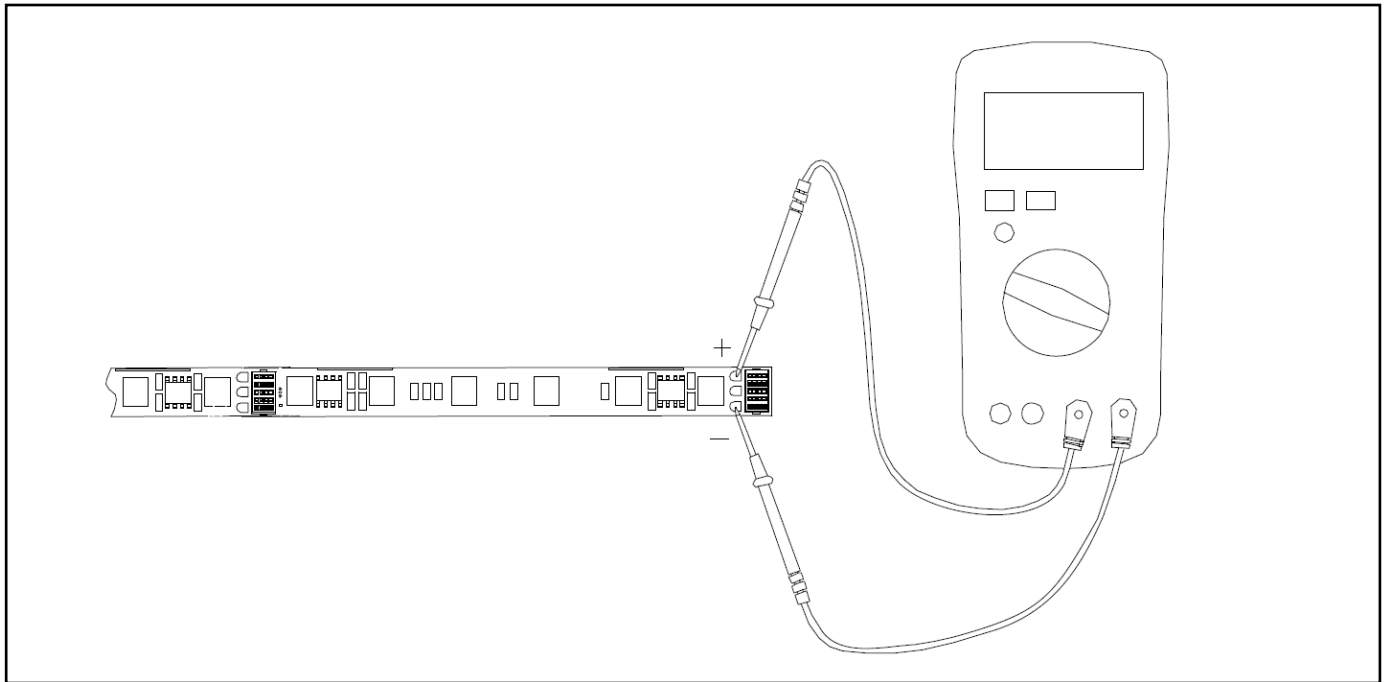
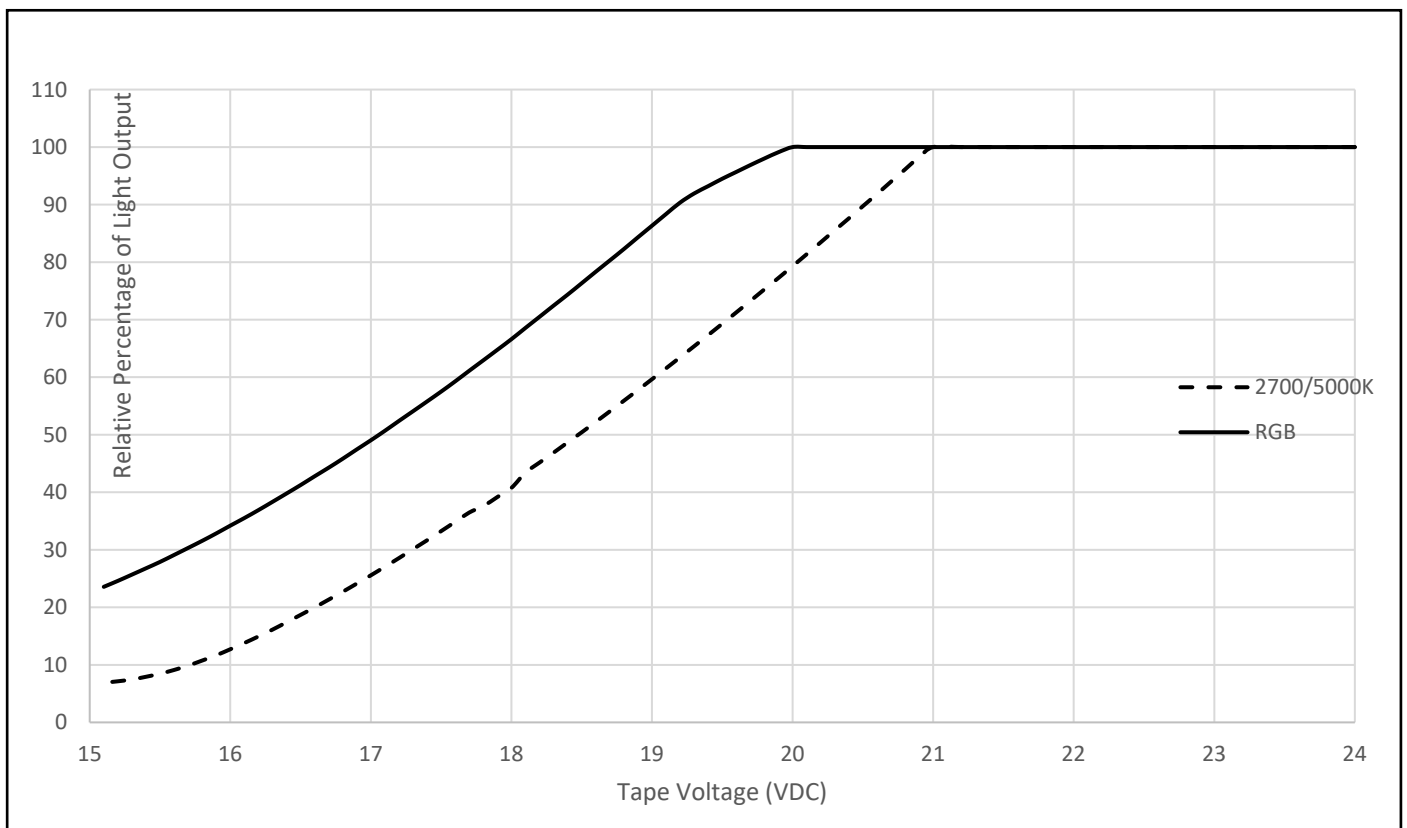

FIG. 10



If need, tape voltage drop and light output lumens along the run length can be calculated using the Table 3 below. The voltage drop value in the table shown is at maximum brightness condition. Lowering the light output will lower the voltage drop along the tape.

Table 3.

Tape Distance →	Voltage Drop at different Tape Distance (VDC) @Full light output																			
	1	2	3	4	5	6	7	8	9	10	11	12	13	14	15	16	17	18	19	20
RGB (White)	0.10	0.21	0.31	0.41	0.52	0.62	0.73	0.83	0.93	1.04	1.14	1.24	1.35	1.45	1.56	1.66	1.76	1.87	1.97	2.07
RED	0.05	0.10	0.15	0.19	0.24	0.29	0.34	0.39	0.44	0.48	0.53	0.58	0.63	0.68	0.73	0.78	0.82	0.87	0.92	0.97
GREEN	0.05	0.10	0.14	0.19	0.24	0.29	0.34	0.39	0.43	0.48	0.53	0.58	0.63	0.68	0.72	0.77	0.82	0.87	0.92	0.97
BLUE	0.05	0.10	0.15	0.19	0.24	0.29	0.34	0.39	0.44	0.48	0.53	0.58	0.63	0.68	0.73	0.77	0.82	0.87	0.92	0.97
2700K	0.07	0.14	0.21	0.28	0.35	0.42	0.49	0.56	0.63	0.70	0.77	0.84	0.91	0.98	1.05	1.12	1.19	1.26	1.33	1.40
2800K	0.08	0.16	0.24	0.32	0.41	0.49	0.57	0.65	0.73	0.81	0.89	0.97	1.05	1.14	1.22	1.30	1.38	1.46	1.54	1.62
2900K	0.09	0.18	0.26	0.35	0.44	0.53	0.62	0.71	0.79	0.88	0.97	1.06	1.15	1.24	1.32	1.41	1.50	1.59	1.68	1.77
3000K	0.09	0.19	0.28	0.38	0.47	0.56	0.66	0.75	0.85	0.94	1.03	1.13	1.22	1.32	1.41	1.50	1.60	1.69	1.79	1.88
3100K	0.10	0.20	0.29	0.39	0.49	0.59	0.69	0.78	0.88	0.98	1.08	1.18	1.27	1.37	1.47	1.57	1.67	1.77	1.86	1.96
3200K	0.10	0.20	0.30	0.40	0.51	0.61	0.71	0.81	0.91	1.01	1.11	1.21	1.32	1.42	1.52	1.62	1.72	1.82	1.92	2.02
3300K	0.10	0.21	0.31	0.42	0.52	0.63	0.73	0.84	0.94	1.05	1.15	1.26	1.36	1.46	1.57	1.67	1.78	1.88	1.99	2.09
3400K	0.11	0.22	0.33	0.44	0.54	0.65	0.76	0.87	0.98	1.09	1.20	1.31	1.42	1.52	1.63	1.74	1.85	1.96	2.07	2.18
3500K	0.11	0.22	0.34	0.45	0.56	0.67	0.79	0.90	1.01	1.12	1.23	1.35	1.46	1.57	1.68	1.80	1.91	2.02	2.13	2.24
3600K	0.12	0.23	0.35	0.46	0.58	0.70	0.81	0.93	1.04	1.16	1.28	1.39	1.51	1.62	1.74	1.85	1.97	2.09	2.20	2.32
3700K	0.12	0.24	0.36	0.48	0.60	0.72	0.84	0.96	1.08	1.20	1.32	1.43	1.55	1.67	1.79	1.91	2.03	2.15	2.27	2.39
3800K	0.12	0.23	0.35	0.46	0.58	0.69	0.81	0.92	1.04	1.15	1.27	1.38	1.50	1.62	1.73	1.85	1.96	2.08	2.19	2.31
3900K	0.11	0.23	0.34	0.45	0.56	0.68	0.79	0.90	1.02	1.13	1.24	1.35	1.47	1.58	1.69	1.81	1.92	2.03	2.14	2.26
4000K	0.11	0.22	0.33	0.44	0.55	0.65	0.76	0.87	0.98	1.09	1.20	1.31	1.42	1.53	1.64	1.74	1.85	1.96	2.07	2.18
4100K	0.11	0.21	0.32	0.43	0.53	0.64	0.75	0.86	0.96	1.07	1.18	1.28	1.39	1.50	1.60	1.71	1.82	1.92	2.03	2.14
4200K	0.10	0.21	0.31	0.42	0.52	0.63	0.73	0.83	0.94	1.04	1.15	1.25	1.35	1.46	1.56	1.67	1.77	1.88	1.98	2.08
4300K	0.10	0.20	0.30	0.41	0.51	0.61	0.71	0.81	0.91	1.01	1.11	1.22	1.32	1.42	1.52	1.62	1.72	1.82	1.92	2.03
4400K	0.10	0.20	0.30	0.40	0.49	0.59	0.69	0.79	0.89	0.99	1.09	1.19	1.28	1.38	1.48	1.58	1.68	1.78	1.88	1.98
4500K	0.10	0.19	0.29	0.39	0.49	0.58	0.68	0.78	0.88	0.97	1.07	1.17	1.27	1.36	1.46	1.56	1.66	1.75	1.85	1.95
4600K	0.09	0.19	0.28	0.38	0.47	0.57	0.66	0.75	0.85	0.94	1.04	1.13	1.23	1.32	1.42	1.51	1.60	1.70	1.79	1.89
4700K	0.09	0.19	0.28	0.37	0.47	0.56	0.65	0.74	0.84	0.93	1.02	1.12	1.21	1.30	1.40	1.49	1.58	1.67	1.77	1.86
4800K	0.09	0.18	0.27	0.36	0.44	0.53	0.62	0.71	0.80	0.89	0.98	1.07	1.15	1.24	1.33	1.42	1.51	1.60	1.69	1.78
4900K	0.09	0.17	0.26	0.35	0.43	0.52	0.61	0.69	0.78	0.87	0.95	1.04	1.13	1.21	1.30	1.39	1.47	1.56	1.65	1.73
5000K	0.07	0.14	0.21	0.28	0.35	0.42	0.49	0.56	0.63	0.70	0.77	0.84	0.91	0.98	1.05	1.12	1.19	1.26	1.34	1.41

Example:

Project: 2700K – 4000K InvisiLED Light
 Distance between DMX Controller to beginning of the tape: 50 ft using 20 AWG
 InvisiLED Tape Max Run: 15 ft.

1ft. Tape Current (Worst case at 3700K): 0.2185 A (refer to Table. 2)
 15 ft. Tape Current: 0.2185 X 15 = 3.2775 A
 Resistane of 20AWG (WAC’s Unshielded cable) per ft: 0.0206 Ω
 Voltage drop from wires between DMX Controller to tape: 3.2775 X (50 X 0.0206) = 3.375V
 Voltage at beginning of the tape: 24 – 3.375 = 20.625V
 Light Output at beginning of the tape: According to FIG. 10, it’s at around 90% with 20.6V. So you would expect 90% of light output that shown in Table 2

Voltage at the end of InvisiLED tape: According to Table 3, the 15 ft tape voltage drop is 1.79V at 3700K, thus 20.625 – 1.79 = 18.835 VDC
 Light Output at the end of InvisiLED tape: According to FIG. 10, it’s around 56% at 18.8V. So you would expect 56% of light output that shown in Table 2

7. If necessary, cut InvisiLED RGBWW tape light to desired length at line indicated with scissors icon. The tape allows for a cut every 4-inch interval. The cut line is shown on both sides of connector. (See FIG. 11)

FIG. 11

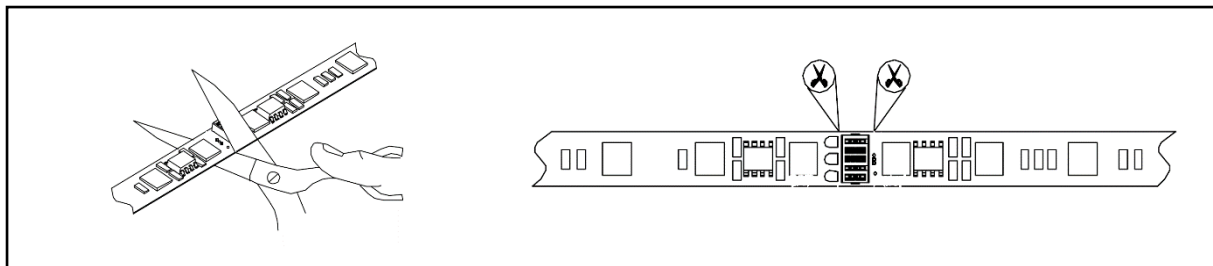

8. Mount InvisiLED RGBWW tape light: clean surface before mounting. Peel off 3M VHB adhesive backing cover off as strip is installed, pressing firmly to mounting surface in increments. (See FIG. 12)

FIG. 12

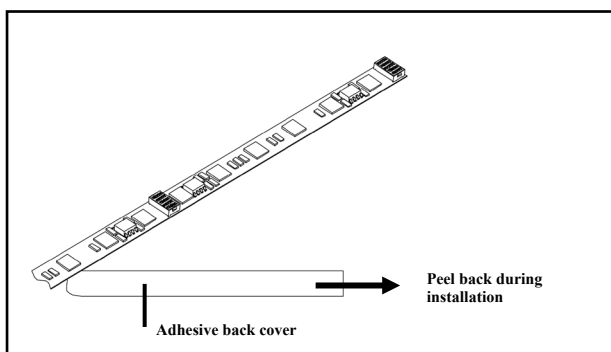

9. Joining between InvisiLED RGBWW tape light

InvisiLED RGBWW tape light has a polarity which means the red color bar has to be same side (See FIG. 13). Joining a tape in an opposite direction will lose an ability to control the tape even though the tape lit up.

Joining tape together (If necessary), the following accessories can be used to join between tapes section depending on your application:

Tape to Tape Connector (T24-MM-WT), See FIG. 13

FIG. 13

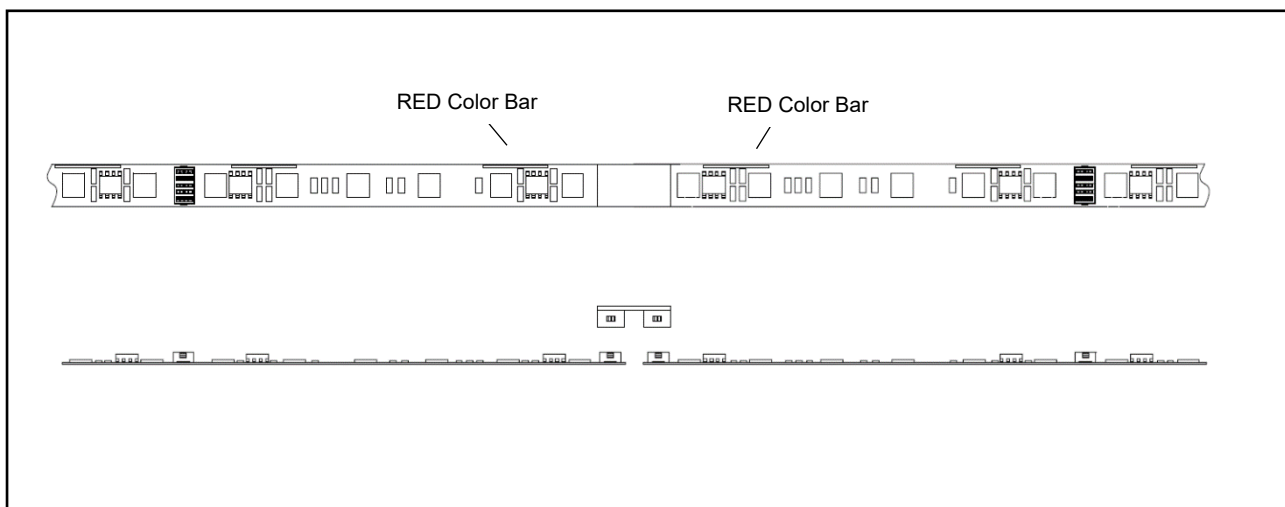

Tape to Tape T Connector (T24-TI-WT), See FIG. 14

FIG. 14

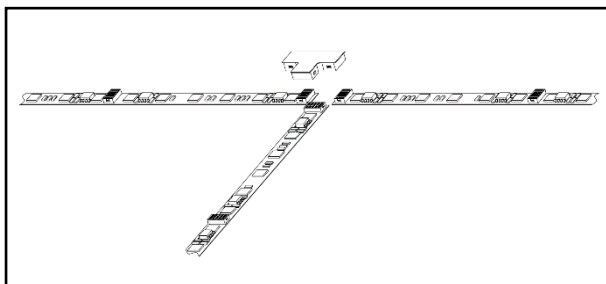

Tape to Tape X Connector (T24-XI-WT), See FIG. 15

FIG. 15

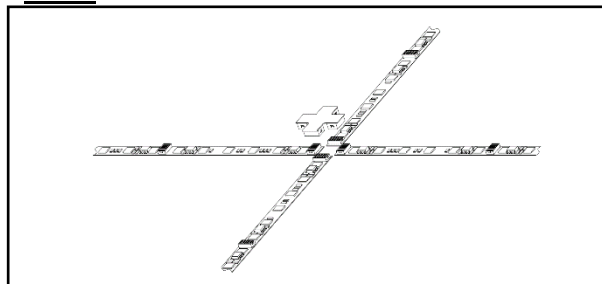

Tape to Tape L Connector (T24-LI-WT), See FIG. 16

FIG. 16

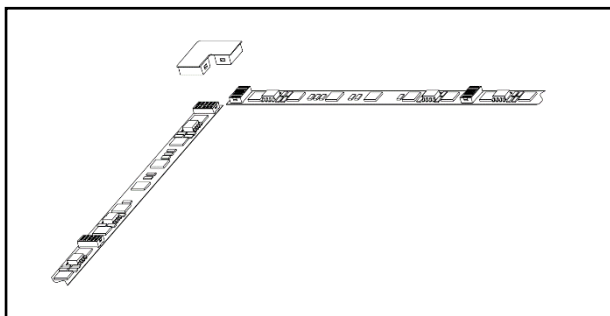

Flex Tape to Tape Y Connector (T24-Y-WT), See FIG. 17

FIG. 17

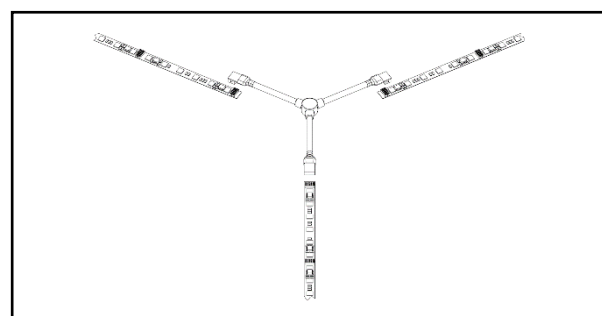

Flex Tape to Tape X Connector (T24-X-WT), See FIG. 18

FIG. 18

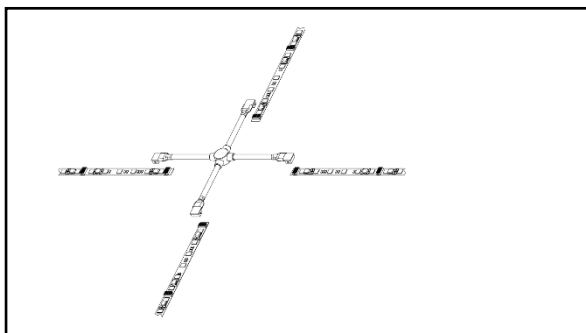

10. Connect electrical power feed connector to any connector on the tape or accessories. Make sure the connection direction is correct.

Feed power from the left
 (RED Color Bar shall be on the top of the tape, See FIG. 19)

FIG. 19

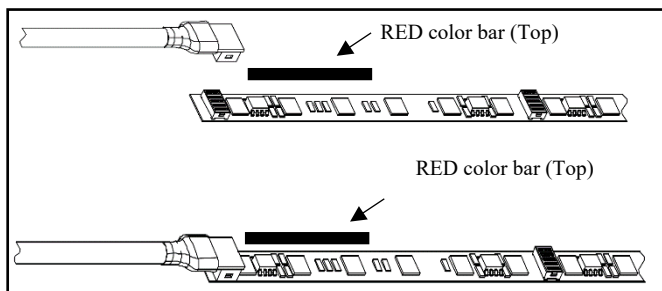

Feed power from the right
 (RED Color Bar shall be at the bottom of the tape, See FIG. 20)

FIG. 20

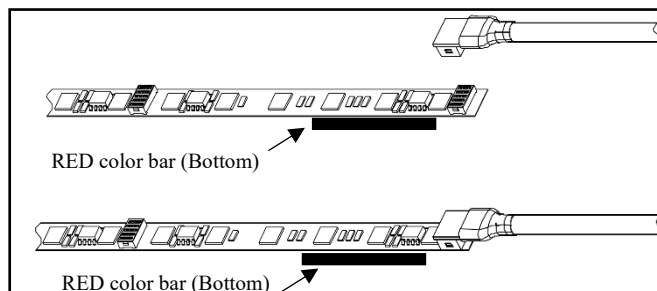

SYSTEM DIAGRAM:

InvisiLED RGBWW shall be used with WAC Wireless DMX LED Controller at all times. Using other DMX controller brands will result in losing an ability to control InvisiLED RGBWW tape light. The following diagram is provided as example system design. (See FIG. 21 & 22)

FIG. 21

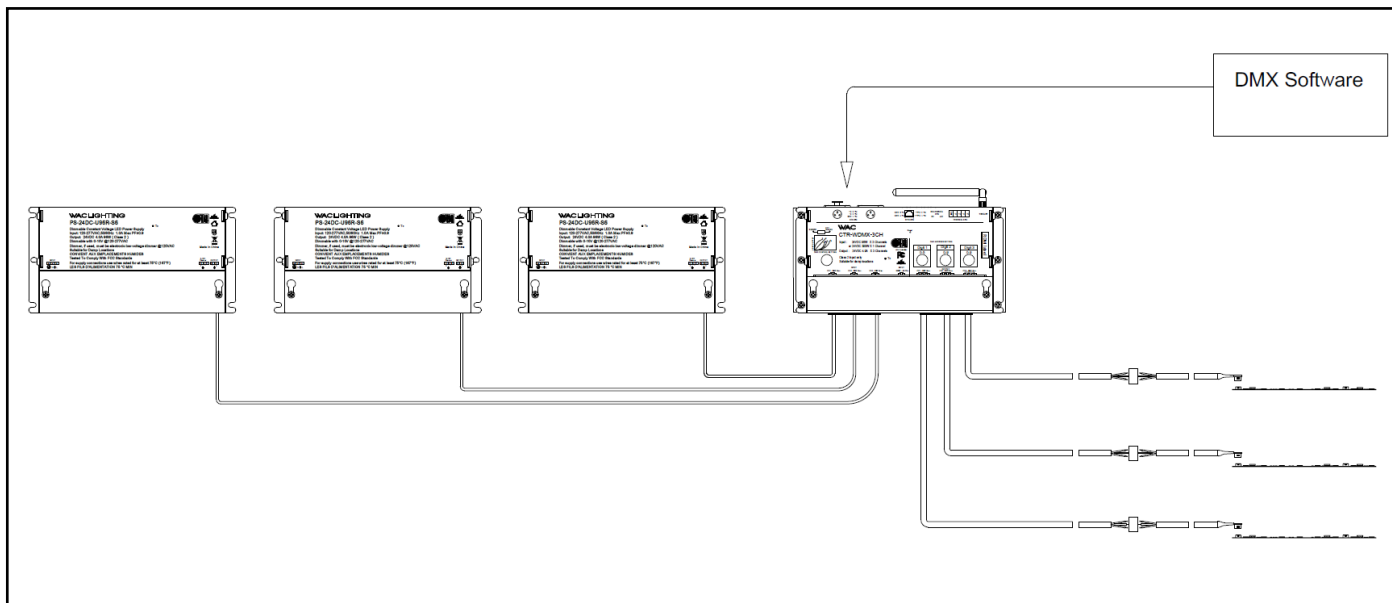
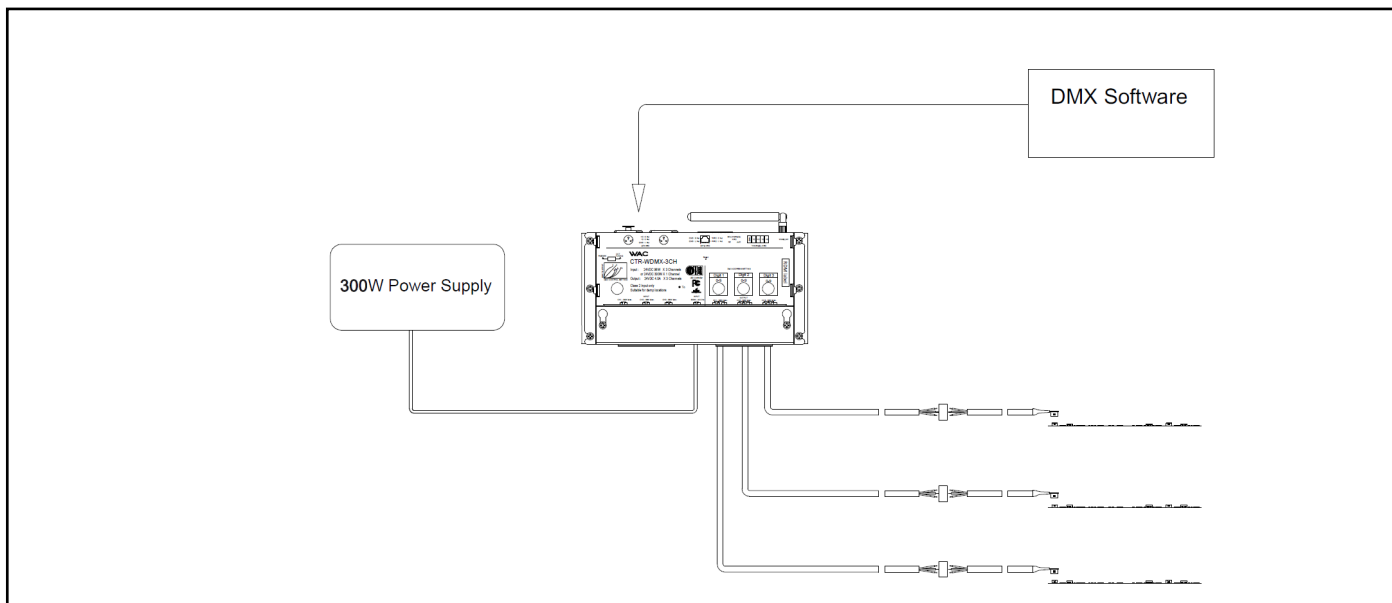

FIG. 22



TROUBLESHOOTING

Symptom

Common Cause and Solution

Light Output turns on/off repeatedly or flashing

The tape consumes too much power than a capacity of power supply. WAC power supply has an overload protection that will trip the internal auto-reset. Exceeding power capacity will repeatedly reset the power supply until an overload condition is removed.

Light output flashes wildly with different color

The data signal communication between Wireless DMX LED Controller and InvisiLED RGBWW tape has a high distortion due to a long run of wires between Power Supply-Wireless DMX LED Controller and InvisiLED Tape. The shield data cable is recommended to use to maintain a good quality data signal. Reducing the run length between Wireless DMX LED Controller to the tape will help solving the problem.

**No light from one section to the end of the run /
Light output flashes wildly with different color from one section to the end of the run**

The InvisiLED RGBWW tape may be damaged due to high degree of bending angle and cause a soldering on the tape to crack and lose electrical solution. To solve this issue quickly is by cutting and remove the first unlit 4 inches long section out and reconnecting the rest of the tape.

**Light output at the end of the run is dim
High contrast between beginning and the end of run.**

This is the voltage drop effects. Using a thicker conductor wire or smaller gauge wire number yields less voltage drop and boost light output up.
Another way is to lower a maximum DMX value to reduce the current consumption to InvisiLED RGBWW tape. Thus, a contrast between beginning and the end of InvisiLED tape run will be smaller.

Make sure that no ELV/TRIAC dimmer is connected to power supply. InvisiLED RGBWW is only control through Wireless DMX LED Controller

InvisiLED RGBWW light overheats

Incorrect voltage pairing, ensure 24V tape light are not paired with a power supply with higher voltage
Incorrect ambient temperature. Ensure tape light is installed in environment -4° - 104°F (-20°C - 40°C)
Lower the maximum light output down to acceptable ranges as recommended in Table. 2

InvisiLED RGBWW does not illuminate

Power Supply Failure, using voltage meter to check.
Incorrect wiring, polarity of positive and negative are reversed.
Incorrect DMX Channel setup, Check the DMX channel setup and properly activate the right channel.

Unable to dim InvisiLED RGBWW light

Make sure a right connection between power feed to tape (See FIG. 19-20)
Make sure a RED color bar is on a right side for all connections between tape to tape.

Sudden Loss control over InvisiLED Tunable White Light

This scenario may happen when you lose control over InvisiLED tunable white suddenly as you ramp up the brightness or increase the power to the tape. This cause by a combination of voltage drop and data quality loss.
To regain control over tape light, please remove the power to the tape, lower the DMX value, and use shield data cable. Make sure that both common and drain wires are all connected on both ends. Or reduce the run length between Wireless DMX LED Controller to the tape.

Unable to light up both RGB and 2700K/5000K at the same time

This feature has been designed in the Wireless DMX LED Controller A2C10-3 to prevent an overflow of power to InvisiLED RGBWW tape that will cause an overheat. Thus, either RGB or WW can be operated at the same time by controlling CH6 (Dimming for RGB) and CH7 (Dimming for WW). CH6 has higher priority than CH7.