



# WP4FCH350PSQ



JOB NAME: \_\_\_\_\_  
 DATE: \_\_\_\_\_  
 TYPE: \_\_\_\_\_

## DESCRIPTION

Fully shielded, Full Cutoff wallpack. Full Cutoff optics with flat tempered glass lens. EZ mount knockouts for easy wiring. Lamp supplied.

## SPECIFICATIONS

### Finish:

Chip and fade resistant polyester powder coating.

### Housing:

Die cast aluminum 1/2" NPS tapped holes top, both sides and back for conduit or photocontrol. Hinged refractor frame, Continuous silicone rubber gasket.

### Reflector:

Specular anodized aluminum, removable for installation. Symmetrical light pattern maximizes distance between fixtures.

### Color:

Bronze

### Refractor:

Prismatic optics designed to minimize glare and throw light down and out. Heat resistant borosilicate glass.

### UL Listing:

Suitable for wet locations. HID fixtures can be wired with 90° C supply wiring if supply wires are routed 3" away from the ballast.

### Patents:

RAB sensor and fixture designs are protected under U.S. and International Intellectual Property laws .

### Weight:

0

## DIMENSIONS

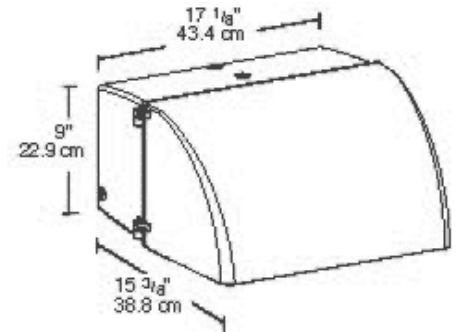

## ORDERING INFORMATION

Metal Halide Lamp supplied with fixture	Total Watts	Lamp Type	Lamp Base	Ballast	Starting Amps/ Operating Amps				Input Watts	LAMP ANSI	Initial Lumens	Lamp Hours
					120V	208V	240V	277V				
	350	ED28	Mogul	CWA HPF QT	3.3/3.6	1.9/2.1	1.7/1.8	1.4/1.6	400	M131	35000	20000

**Factory Installed Options**  
 Add suffix to Catalog Number

Tamperproof screws (/TP)  
 Swivel Photocontrol (/PCS)  
 Single fusing for 120 and 277 volt (/F)

Quartz Restrike (/QR)  
 Double fusing for 208 and 240 volt (/FF)  
 Button Photocontrol (/PC)  
 480 volt only ballast (substitute /480 for QT)

Note: Specifications may change without notice