



WP2CSN100W



JOB NAME: _____
 DATE: _____
 TYPE: _____

DESCRIPTION

Wallpack with cutoff glare shield. All aluminum precision die cast construction with tempered glass lens. 30° cutoff strip included. Lamp supplied.

SPECIFICATIONS

Cutoff Lens:

Tempered glass.

Finish:

Chip and fade resistant polyester powder coating.

Housing:

Die cast aluminum, 1/2" NPS tapped holes top, both sides and back for conduit or photocontrol. Hinged refractor frame. Continuous silicone rubber gasket.

Reflector:

Specular anodized aluminum, removable for installation. Symmetrical light pattern maximizes distance between fixtures.

Refractor:

Prismatic optics designed to minimize glare and throw light down and out. Heat resistant borosilicate glass.

UL Listing:

Suitable for wet locations. HID fixtures can be wired with 90° C supply wiring if supply wires are routed 3" away from ballast.

Patents:

RAB sensor and fixture designs are protected under U.S. and International Intellectual Property laws

Color:

White

Weight:

13.45

DIMENSIONS

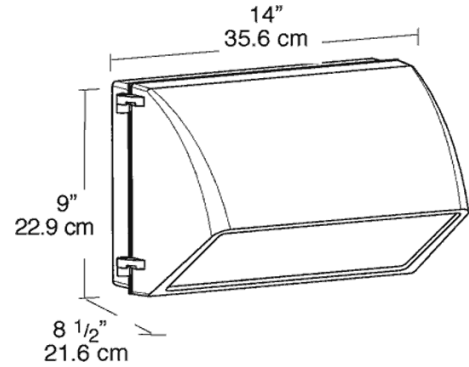

PHOTOMETRIC

150w HPS @10' Mounting Height

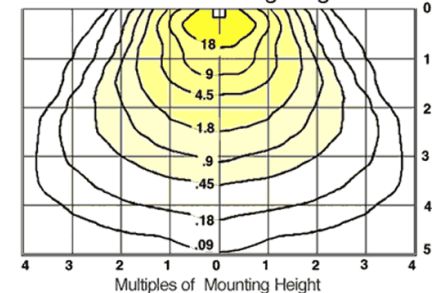

Mounting Height	Multiplier	Watts	Multiplier	HPS	MH	CFL
8'	1.6	175	1.0			
10'	1.0	150	1.1	.9		
12'	.7	100	.6	.6		
16'	.4	70	.4	.4		
20'	.25	42		.2		

ORDERING INFORMATION

High Pressure Sodium
 Lamp supplied with fixture

Total Watts	Lamp Type	Lamp Base	Ballast
100	ED17	Medium	R-NPF 120V

Starting Amps/ Operating Amps				Input Watts	LAMP ANSI	Initial Lumens	Lamp Hours
120V	208V	240V	277V				
3.1/2.1				115	S54	9500	24000

Factory Installed Options
 Add suffix to Catalog Number

Tamperproof screws (/TP)
 Swivel Photocontrol (/PCS)
 Single fusing for 120 and 277 volt (/F)

Double fusing for 208 and 240 volt (/FF)
 Button Photocontrol for 208 - 277 volt (/PC2)
 Button Photocontrol (/PC)

Note: Specifications may change without notice