

RAB LIGHTING

WP1CSN70



JOB NAME: _____
 DATE: _____
 TYPE: _____

DESCRIPTION

Cutoff Wallpack. Lens is flat with tempered glass. Lamp supplied.

SPECIFICATIONS

Finish:

Chip and fade resistant polyester powder coating.

Housing:

Die cast aluminum, 1/2" NPS tapped top, both sides and back for conduit or photocontrol. Hinged refractor. Continuous one piece silicone rubber gasket.

Reflector:

Semi-Specular anodized aluminum, removable for installation. Symmetrical light pattern maximizes distance between fixtures.

UL Listing:

Suitable for wet locations. HID fixtures can be wired with 90° C supply wiring if supply wires are routed 3" away from the ballast.

Conduit Openings:

Top, side and back

Patents:

Pat. D440,683

Template:

Drilling template for easy wall box mounting

Color:

Bronze

Weight:

8.17

DIMENSIONS

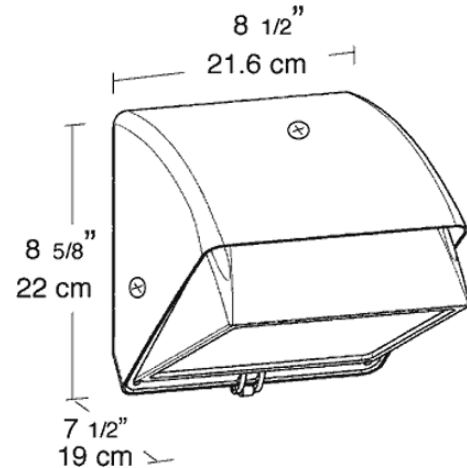

PHOTOMETRIC

70w MH @10' Mounting Height

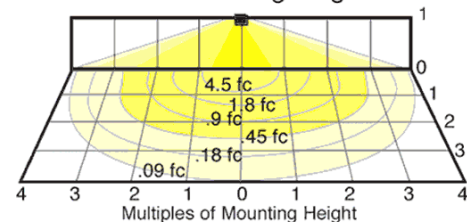

Mounting Height	Multiplier	Multiplier		
		Watts	HPS	MH CFL
8'	1.6	100	1.7	1.6
10'	1.0	70	1.1	1.0
12'	.7	50	.7	.6
16'	.4	42		.6
20'	.25	35	.4	

ORDERING INFORMATION

High Pressure Sodium
Lamp supplied with fixture

Total Watts	Lamp Type	Lamp Base	Ballast
70	ED17	Medium	R-NPF 120V

Starting Amps/ Operating Amps			
120V	208V	240V	277V
2.1/1.6			

Input Watts	LAMP ANSI	Initial Lumens	Lamp Hours
86	S62	6300	24000

Factory Installed Options
Add suffix to Catalog Number

Tamperproof screws (/TP)
Swivel Photocontrol (/PCS)
Single fusing for 120 and 277 volt (/F)

Button Photocontrol wired for 208 - 277 volt (/PC2)
Button Photocontrol (/PC)

Note: Specifications may change without notice