



High performance LED tallpack. Covers footprint of most HID Tallpacks. Vandal resistant lens. Precision die-cast aluminum. 0-10V dimmable driver with 120-277V photocell.

Color: White

Weight: 6.5 lbs

<b>Project:</b>	<b>Type:</b>
<b>Prepared By:</b>	<b>Date:</b>

Driver Info		LED Info	
Type:	Constant Current	Watts:	40W
120V:	0.322A	Color Temp:	4000K (Neutral)
208V:	0.202A	Color Accuracy:	73 CRI
240V:	0.175A	L70 Lifespan:	100000
277V:	0.147A	Lumens:	4015
Input Watts:	38W	Efficacy:	106 LPW
Efficiency:	N/A		

## Technical Specifications

### Listings

#### UL Listing:

Suitable for wet locations. Wall mount only.

#### IESNA LM-79 & LM-80 Testing:

RAB LED luminaires and LED components have been tested by an independent laboratory in accordance with IESNA LM-79 and LM-80.

### LED Characteristics

#### Lifespan:

100,000-hour LED lifespan based on IES LM-80 results and TM-21 calculations

#### LEDs:

Long-life, high-efficacy surface mount LEDs

#### Color Stability:

LED color temperature is warranted to shift no more than 200K in CCT over a 5 year period

#### Color Uniformity:

RAB's range of CCT (Correlated Color Temperature) follows the guidelines of the American National Standard for Specifications for the Chromaticity of Solid State Lighting (SSL) Products, ANSI C78.377-2017.

### Electrical

#### Drivers:

Constant Current, Class 2, 900mA, 100-277V, 50-60Hz, 120V: 0.322A, 208V: 0.202A, 240V: 0.175A, 277V: 0.147A, Surge Protection: 6kV

#### Power Factor:

99.0% at 120V, 92.8% at 277V

#### THD:

10.9% at 120V, 15.2% at 277V

#### Dimming Driver:

0-10V dimming driver standard for ultimate flexibility. Use as on/off or utilize the 0-10V DC dimming circuit for controls.

#### Photocell:

Photocell is rated for 120V thru 277V. To disable, simply use the provide silicone rubber cap and cover.

### Optical

#### BUG Rating:

B0 U4 G3

### Construction

#### Ambient Temperature:

Suitable for -40°C (-40°F) to 40°C (104°F) ambient temperatures

#### Cold Weather Starting:

Minimum starting temperature is -40°C (-40°F)

#### Thermal Management:

Superior thermal management with die-cast aluminum heatsink

#### Housing:

Precision die-cast aluminum

#### Reflector Lens:

High-impact, diffuse, UV-stabilized polycarbonate

#### Mounting:

Three (3) 1/2" NPS conduit entry points (2 sides for through-feed, and bottom), and drilling template for easy wall box mounting

#### Reflector:

High-gloss white aluminum

#### Gaskets:

High-temperature silicone gaskets

#### Finish:

Formulated for high-durability and long lasting color

#### Green Technology:

Mercury and UV-free. RoHS compliant components. Polyester powder coat finish formulated without the use of VOCs or toxic heavy metals.

### Other

#### Equivalency:

Equivalent to 100W Metal Halide/70W HPS

#### Warranty:

RAB warrants that our LED products will be free from defects in materials and workmanship for a period of five (5) years from the date of delivery to the end user, including coverage of light output, color stability, driver performance and fixture finish. RAB's warranty is subject to all terms and conditions found at

#### Patents:

The design of WPTLED is protected by patents pending in US, Canada, China, Taiwan and Mexico

# WPTLED40NW/D10/PC2

## Dimensions

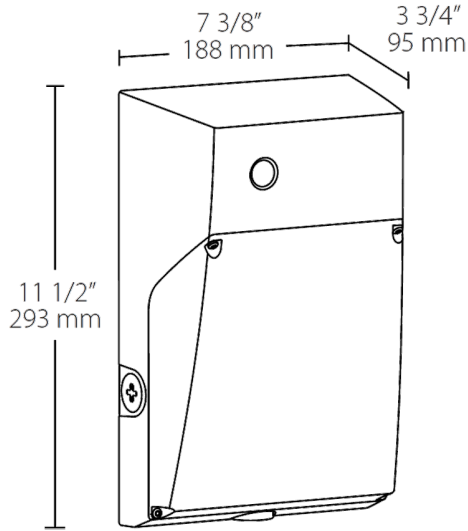

## Features

- Covers footprints of most HID tallpacks
- 0-10V dimmable driver & 120 - 277V photocell
- Vandal-resistant lens
- 100,000-Hour LED lifespan

## Ordering Matrix

Family	Wattage	Color Temp	Finish	Dimming	Photocell	Lightcloud	Other Options
WPTLED	40	N	W	/D10	/PC2	^	^
40 = 40W		Blank = 5000K (Cool)	Blank = Bronze	/D10 = Dimmable	/PC2 = 120-277V Photocell	Blank = No Lightcloud	USA = BAA Compliant
25 = 25W		Y = 3000K (Warm)	W = White			/LC = Lightcloud Controller	Blank = Standard
12 = 12W		N = 4000K (Neutral)					