



High performance LED tallpack. Covers footprint of most HID Tallpacks. Vandal resistant lens. Precision die-cast aluminum. 0-10V dimmable driver with 120-277V photocell.

Color: Bronze

Weight: 6.5 lbs

Project:

Type:

Prepared By:

Date:

Driver Info

Type: Constant Current
 120V: 0.201A
 208V: 0.126A
 240V: 0.109A
 277V: 0.096A
 Input Watts: 24W
 Efficiency: N/A

LED Info

Watts: 25W
 Color Temp: 4000K (Neutral)
 Color Accuracy: 73 CRI
 L70 Lifespan: 100000
 Lumens: 2517
 Efficacy: 106 LPW

Technical Specifications

Listings

UL Listing:

Suitable for wet locations. Wall mount only.

IESNA LM-79 & LM-80 Testing:

RAB LED luminaires and LED components have been tested by an independent laboratory in accordance with IESNA LM-79 and LM-80.

LED Characteristics

Lifespan:

100,000-hour LED lifespan based on IES LM-80 results and TM-21 calculations

LEDs:

Long-life, high-efficacy surface mount LEDs

Color Stability:

LED color temperature is warranted to shift no more than 200K in CCT over a 5 year period

Color Uniformity:

RAB's range of CCT (Correlated Color Temperature) follows the guidelines of the American National Standard for Specifications for the Chromaticity of Solid State Lighting (SSL) Products, ANSI C78.377-2017.

Electrical

Drivers:

Constant Current, Class 2, 550mA, 100-277V, 50-60Hz, 120V: 0.201A, 208V: 0.126A, 240V: 0.109A, 277V: 0.096A, Surge Protection: 6kV

Power Factor:

98.8% at 120V, 91.4% at 277V

THD:

12.6% at 120V, 16.4% at 277V

Dimming Driver:

0-10V dimming driver standard for ultimate flexibility. Use as on/off or utilize the 0-10V DC dimming circuit for controls.

Photocell:

Photocell is rated for 120V thru 277V. To disable, simply use the provide silicone rubber cap and cover.

Optical

BUG Rating:

B0 U3 G2

Construction

Ambient Temperature:

Suitable for -40°C (-40°F) to 40°C (104°F) ambient temperatures

Cold Weather Starting:

Minimum starting temperature is -40°C (-40°F)

Thermal Management:

Superior thermal management with die-cast aluminum heatsink

Housing:

Precision die-cast aluminum

Reflector Lens:

High-impact, diffuse, UV-stabilized polycarbonate

Mounting:

Three (3) 1/2" NPS conduit entry points (2 sides for through-feed, and bottom), and drilling template for easy wall box mounting

Reflector:

High-gloss white aluminum

Gaskets:

High-temperature silicone gaskets

Finish:

Formulated for high-durability and long lasting color

Green Technology:

Mercury and UV-free. RoHS compliant components. Polyester powder coat finish formulated without the use of VOCs or toxic heavy metals.

Other

Equivalency:

Equivalent to 70W Metal Halide/50W HPS

Warranty:

RAB warrants that our LED products will be free from defects in materials and workmanship for a period of five (5) years from the date of delivery to the end user, including coverage of light output, color stability, driver performance and fixture finish. RAB's warranty is subject to all terms and conditions found at

Patents:

The design of WPTLED is protected by patents pending in US, Canada, China, Taiwan and Mexico

Dimensions

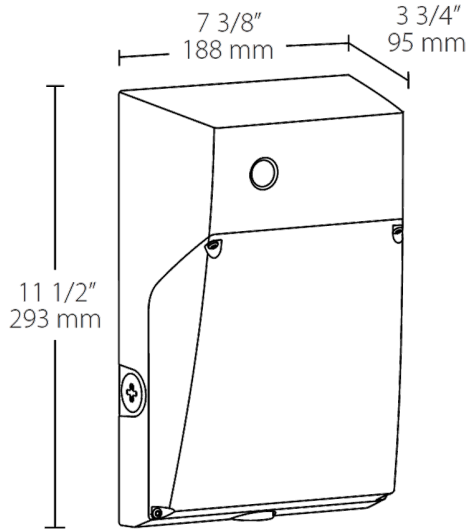

Features

- Covers footprints of most HID tallpacks
- 0-10V dimmable driver & 120 - 277V photocell
- Vandal-resistant lens
- 100,000-Hour LED lifespan

Ordering Matrix

Family	Wattage	Color Temp	Finish	Dimming	Photocell	Lightcloud	Other Options
WPTLED	25	N	^	/D10	/PC2	^	^
40 = 40W		Blank = 5000K (Cool)	Blank = Bronze	/D10 = Dimmable	/PC2 = 120-277V Photocell	Blank = No Lightcloud	USA = BAA Compliant
25 = 25W		Y = 3000K (Warm)	W = White			/LC = Lightcloud Controller	Blank = Standard
12 = 12W		N = 4000K (Neutral)					