



VXBR200DG



JOB NAME: _____
 DATE: _____
 TYPE: _____

DESCRIPTION

Die cast aluminum construction. Wall bracket plus junction box with sturdy mounting lugs. Medium base socket, 1/2" or 3/4" NPS hub size and a variety of globes. Incandescent up to 300 watts. CFL 13 or 22 watts. CFL lamp supplied. Incandescent lamp not supplied.

SPECIFICATIONS

Globes:

Supplied with clear heat resistant glass globes unless otherwise stated. Colored and white glass globes available. Unbreakable RAB Permaglobes available in clear and in color.

Optional Reflectors:

Highly reflective white baked polyester epoxy powder finish over a heavy gauge aluminum base. Reflectors thread onto fixtures. See RV series.

Socket:

Premium porcelain with 150° C 8" leads attached. Fastened with 2 brass screws.

Wattage:

See catalog number chart for maximum wattage with clear glass, colored glass and Permaglobes.

Colored Globe Maximum Watts:

200 watts

UL Listing:

Suitable for wet locations. Suitable for use in dwellings. Suitable for use with 90° C supply wiring. Complies with UL Standard 1598. For non-hazardous locations where the lamp, socket and wiring require protection from rain, corrosive fumes, non-combustible dusts, moisture, non-explosive vapors and gases.

Die Cast Guard:

Supplied with one piece die cast guard with set screw

Maximum Watts:

300 watts

Patents:

RAB sensor and fixture designs are protected under U.S. and International Intellectual Property laws.

Color:

Natural

Weight:

4.67

DIMENSIONS

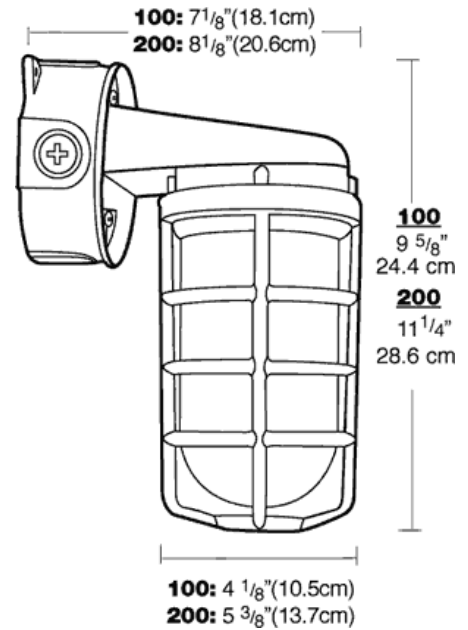

ORDERING INFORMATION

Total Watts	Lamp Type	Lamp Base	Ballast	Starting Amps/ Operating Amps				Input Watts	LAMP ANSI	Initial Lumens	Lamp Hours
				120V	208V	240V	277V				
300	A19	Medium	0	0	0	0	0	0	0	0	

Factory Installed Options
 Add suffix to Catalog Number

Note: Specifications may change without notice

RAB Lighting, Inc. • 170 Ludlow Ave • Northvale, NJ 07647 • Tel: 888 RAB-1000 • Fax: 888 RAB-1232 • www.rabweb.com
 © 2010 RAB Lighting, Inc.