



VXBR2SN50W



JOB NAME: _____
 DATE: _____
 TYPE: _____

DESCRIPTION

Cast aluminum housing with sturdy wall mounting bracket for 50, 70 & 100 watt HPS, 50, 70 & 100 watt Metal Halide. Prismatic globe for low glare and even light distribution. Fixture mounts to junction box or can be wired inside the housing. Wall mounted with 1/2" (or 3/4") side and top conduit feel. Lamp supplied.

SPECIFICATIONS

Construction:

Die cast aluminum with brass screws

Globes:

Clear prismatic, heat resistant glass standard. White glass globes available. Colored and clear unbreakable RAB Permaglobes available for CFL only.

Guard:

One piece die cast aluminum with set screw

Optional Reflectors:

Highly reflective white baked polyester epoxy powder finish over a heavy gauge aluminum base. Reflectors thread onto fixtures.

Socket:

HID: Glazed porcelain 4kv pulse rated with nickel plated screw shell and spring contacts. CFL: White thermo plastic with integral clips for lamp retention.

UL Listing:

Suitable for wet locations. Complies with UL Standard 1598 for non-hazardous locations where the lamp, socket and wiring require protection from air, corrosive fumes, non-combustible dusts, moisture, non-explosive vapors and gases. For lamp base up installation only when outdoors.

Patents:

RAB sensor and fixture designs are protected under U.S. and International Intellectual Property laws

Color:

White

Weight:

8.15

DIMENSIONS

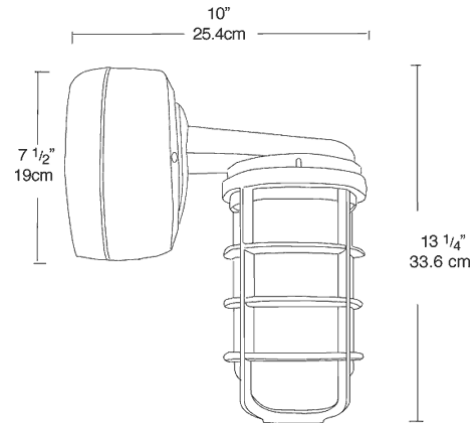

ORDERING INFORMATION

High Pressure Sodium Lamp supplied with fixture	Total Watts	Lamp Type	Lamp Base	Ballast	Starting Amps/ Operating Amps				Input Watts	LAMP ANSI	Initial Lumens	Lamp Hours
					120V	208V	240V	277V				
	50	ED17	Medium	R-NPF 120V	1.8	1.2			62	S68	4000	24000

Factory Installed Options
 Add suffix to Catalog Number

Note: Specifications may change without notice

RAB Lighting, Inc. • 170 Ludlow Ave • Northvale, NJ 07647 • Tel: 888 RAB-1000 • Fax: 888 RAB-1232 • www.rabweb.com
 © 2010 RAB Lighting, Inc.