



VXBR2F32S



JOB NAME: _____
 DATE: _____
 TYPE: _____

DESCRIPTION

Small cast aluminum housing with sturdy wall mounting bracket for 13 and 26 watt or larger size housing for 32 and 42 compact fluorescent. Prismatic globe for low glare and even light distribution. Fixture mounts to junction box or can be wired inside the housing. Ceiling mounted with 1/2" (or 3/4") side and top conduit feed. Lamp supplied.

SPECIFICATIONS

Construction:

Die cast aluminum with brass screws

Globes:

Clear prismatic, heat resistant glass standard. White glass globes available. Colored and clear unbreakable RAB Permaglobes available for CFL only.

Guard:

One piece die cast aluminum with set screw

Optional Reflectors:

Highly reflective white baked polyester epoxy powder finish over a heavy gauge aluminum base. Reflectors thread onto fixtures.

Socket:

HID: Glazed porcelain 4kv pulse rated with nickel plated screw shell and spring contacts. CFL: White thermo plastic with integral clips for lamp retention.

UL Listing:

Suitable for wet locations. Complies with UL Standard 1598 for non-hazardous locations where the lamp, socket and wiring require protection from air, corrosive fumes, non-combustible dusts, moisture, non-explosive vapors and gases. For lamp base up installation only when outdoors.

Ballast Minimum Starting Temperature:

0° F

Patents:

RAB sensor and fixture designs are protected under U.S. and International Intellectual Property laws

Color:

Silver

Weight:

4.35

DIMENSIONS

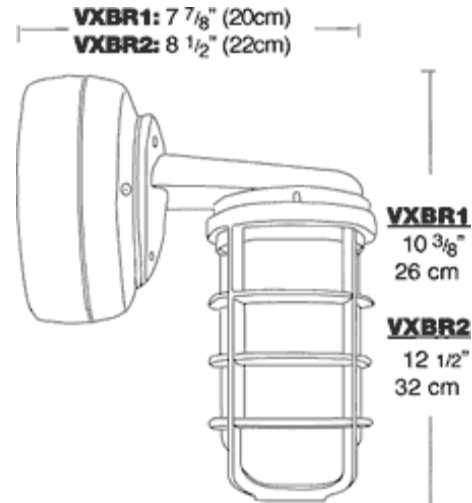

ORDERING INFORMATION

Compact Fluorescent Lamp supplied with fixture	Total Watts	Lamp Type	Lamp Base	Ballast	Starting Amps/ Operating Amps				Input Watts	LAMP ANSI	Initial Lumens	Lamp Hours
					120V	208V	240V	277V				
	32	32w Triple	GX24q-3	Elec HPF QT	0.31	0.2	0.2	0.13	32		2400	12000

Factory Installed Options
 Add suffix to Catalog Number

Note: Specifications may change without notice

RAB Lighting, Inc. • 170 Ludlow Ave • Northvale, NJ 07647 • Tel: 888 RAB-1000 • Fax: 888 RAB-1232 • www.rabweb.com
 © 2010 RAB Lighting, Inc.