

VC100DGW

JOB NAME: _____

DATE: _____

TYPE: _____

DESCRIPTION

Die cast aluminum construction. Mounts to existing surface or recessed 4" boxes Adapter plate provided. Medium base socket and a variety of globes. Incandescent up to 150 watts (lamp not supplied). CFL: 13 or 22 watts (Lamp supplied).

SPECIFICATIONS

Globes:

Supplied with clear thermal shock resistant soda lime glass unless otherwise stated. Colored and white glass globes available. Unbreakable Permaglobes available in clear and in color.

UL Listing:

Suitable for wet locations. Suitable for use in dwellings. Suitable for use with 90° C supply wiring. Complies with UL Standard 1598. For non-hazardous locations where the lamp, socket and wiring require protection from rain, corrosive fumes, non-combustible dusts, moisture, non-explosive vapors and gases. For lamp base up installation only when outdoors.

Colored Globe Maximum Watts:

100 watts

Die Cast Guard:

Supplied with one piece white die cast guard with set screw

Maximum Watts:

100 watts

Patents:

RAB sensor and fixture designs are protected under U.S. and International Intellectual Property laws.

Color:

White

Weight:

2.34

DIMENSIONS

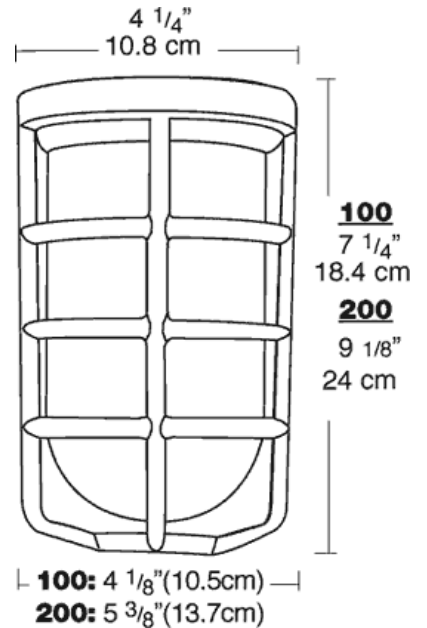

ORDERING INFORMATION

Total Watts	Lamp Type	Lamp Base	Ballast	Starting Amps/ Operating Amps				Input Watts	LAMP ANSI	Initial Lumens	Lamp Hours
				120V	208V	240V	277V				
100	A19	Medium	0	0	0	0	0	0	0	0	

Factory Installed Options

Add suffix to Catalog Number

Note: Specifications may change without notice