



# VAN5F84QT/E2

JOB NAME: \_\_\_\_\_

DATE: \_\_\_\_\_

TYPE: \_\_\_\_\_

## DESCRIPTION

### SPECIFICATIONS

#### Backup Battery

Bodine "Coldpak" operates CFL lamp for 90 minutes after power failure. Maintenance free NiCad battery lasts 7-10 years. Rated -18° C to +55° C

#### Refractor:

Injection molded polycarbonate, designed for maximum structural strength

#### Ballast Minimum Starting Temperature:

0° F

#### UL Listing:

Suitable for wet locations. Fixtures can be wired with 90° C supply wiring if supply wires are routed 3" away from ballast.

#### E2:

Wired for 277V

#### Patents:

Pat. D547,484

#### Color:

Bronze

#### Weight:

12.67

### DIMENSIONS

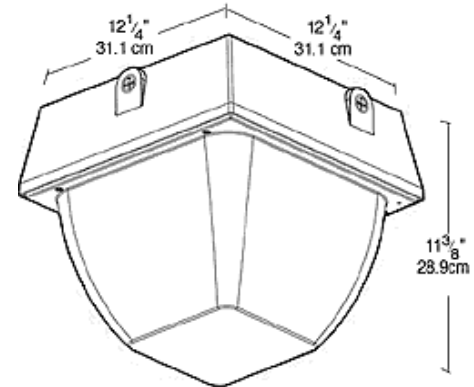

## ORDERING INFORMATION

**Compact Fluorescent**  
Lamp supplied with fixture

Total Watts	Lamp Type	Lamp Base	Ballast	Starting Amps/ Operating Amps				Input Watts	LAMP ANSI	Initial Lumens	Lamp Hours
				120V	208V	240V	277V				
84	2-42W Triple	GX24q-4	Elec HPF QT	0.78	0.5	0.5	0.33	93		6400	12000

**Factory Installed Options**  
Add suffix to Catalog Number

Note: Specifications may change without notice

**RAB Lighting, Inc.** • 170 Ludlow Ave • Northvale, NJ 07647 • Tel: 888 RAB-1000 • Fax: 888 RAB-1232 • www.rabweb.com  
© 2009