



LED roadway lighting that replaces up to 250W MH or 150W HPS. Optics are factory installed and meet IES Distribution Type II.

Color: Gray

Weight: 9.2 lbs

Project:	Type:
Prepared By:	Date:

Driver Info		LED Info	
Type:	Constant Current	Watts:	32W
120V:	0.27A	Color Temp:	5000K
208V:	.17A	Color Accuracy:	72 CRI
240V:	.15A	L70 Lifespan:	100000
277V:	.13A	Lumens:	3,713
Input Watts:	32W	Efficacy:	117 LPW
Efficiency:	N/A		

Technical Specifications

Listings

UL Listing:

Suitable for wet locations. Minimum of 75° supply conductors.

IESNA LM-79 & IESNA LM-80 Testing:

RAB LED fixtures have been tested by an independent laboratory in accordance with IESNA LM-79 and 80, and have received the Department of Energy "Lighting Facts" label.

Construction

IES Classification:

The Type II distribution is ideal for wide walkways, on ramps and entrance roadways, bike paths and other long and narrow lighting applications. This type is meant for lighting larger areas and usually is located near the roadside. This type of lighting is commonly found on smaller side streets or jogging paths.

IP Rating:

Ingress Protection rating of IP66 for dust and water

Vibration Rating:

Industry-leading 5G vibration rating per ANSI C136.31.

Ambient Temperature:

Suitable for use in 104° F (40° C) ambient temperatures.

Cold Weather Starting:

The minimum starting temperature is -22° F (-30° C).

Thermal Management:

Superior thermal management design with external Air-Flow fins provides maximum operational life, even in high ambient temperature environments.

Housing:

Die cast aluminum housing with polycarbonate driver cover.

Lens:

Clear acrylic lens with integrated optics

Mounting:

Fits most standard roadway upsweep arms. Adaptor brackets supplied fit 1", 1 1/4", 1 1/2" and 2" pipe arms. Fixture can be tilted at the following angles -5°, -2.5°, 0°, +2.5°, +5°.

Gaskets:

High temperature silicone gaskets

Effective Projected Area:

EPA = 0.7

Finish:

Our environmentally friendly polyester powder coatings are formulated for high-durability and long-lasting color, and contains no VOC or toxic heavy metals.

Green Technology:

Mercury and UV free. RoHS compliant components. Polyester powder coat finish formulated without the use of VOC or toxic heavy metals.

LED Characteristics

LEDs:

Multi-chip, high-output, long-life LEDs

Color Uniformity:

RAB's range of CCT (Correlated Color Temperature) follows the guidelines of the American National Standard for Specifications for the Chromaticity of Solid State Lighting (SSL) Products, ANSI C78.377-2015.

Electrical

Drivers:

Constant Current, Class 2, 120-277V, 50-60Hz, 120V: 0.27A, 208A: 0.17A, 240A: 0.15A, 277V: 0.13A

Dimming Driver:

Driver includes dimming control wiring for 0-10V dimming systems. Requires separate 0-10V DC dimming circuit. Dims as low as 10%.

7-Pin Receptacle:

ANSI C136.41 7-pin receptacle, compatible with wireless control systems

Surge Protection:

10KV

Optical

BUG Rating:

B1 U0 G1

Other

Equivalency:

Replaces 70W Metal Halide or 50W HPS.

Accessory:

Shorting Cap for 7-Pin Receptacle

Country of Origin:

Designed by RAB in New Jersey and assembled in the USA by RAB's IBEW Local 3 workers.

Buy American Act Compliant:

This product is a COTS item manufactured in the United States, and is compliant with the Buy American Act.

Technical Specifications (continued)

Other

Recovery Act (ARRA) Compliant:

This product complies with the 52.225-21 "Required Use of American Iron, Steel, and Manufactured Goods-- Buy American Act-- Construction Materials (October 2010).

GSA Schedule:

Suitable in accordance with FAR Subpart 25.4.

Dimensions

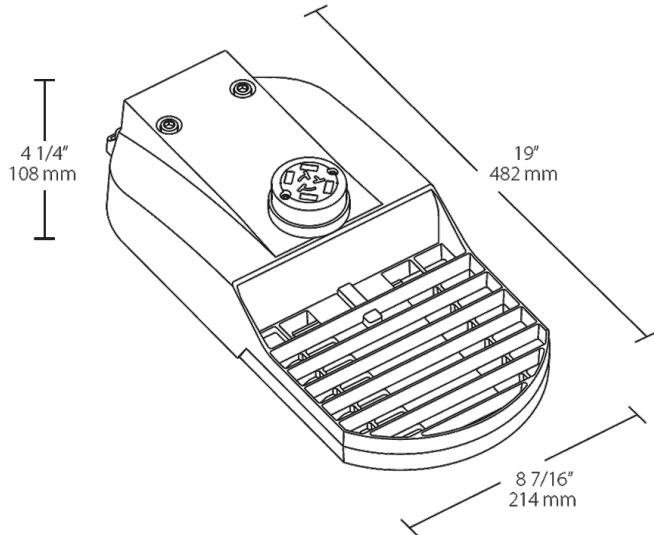

Features

- IP66 Rated
- Industry-leading 5G vibration rating per ANSI C136.31
- ANSI C136.41 7-pin receptacle, compatible with wireless control systems
- 100,000-Hour LED lifespan
- 10-Year limited warranty

Ordering Matrix

Family	IES Type	Wattage	Color Temp	Color	Driver Options	Sensor Options
TBLED	2T	32		RG	/D10	/7PR
	2T = Type II	95 = 95W 64 = 64W 48 = 48W 32 = 32W	Blank = 5000K (Cool) N = 4000K (Neutral) Y = 3000K (Warm) AY = 2000K (HPS Warm)	RG = Roadway Gray	/D10 = 0-10V Dimming (standard) /480/D10 = 480V 0-10V Dimming	/7PR = 7-Pin Receptacle (standard) /7PRS = 7-Pin Receptacle w/ Shorting Cap /PCT = 120-277V Twistlock Photocell w/ 7-Pin Receptacle /PCT4 = 480V Twistlock Photocell w/ 7-Pin Receptacle