



Project:	Type:
Prepared By:	Date:

Driver Info		LED Info	
Type:	Constant Current	Watts:	40W
120V:	0.33A	Color Temp:	3500K
208V:	0.21A	Color Accuracy:	81 CRI
240V:	0.19A	L70 Lifespan:	50000
277V:	0.16A	Lumens:	4,206
Input Watts:	39W	Efficacy:	107 LPW
Efficiency:	N/A		

Technical Specifications

Lightcloud

Lightcloud Installed:

Lightcloud is a commercial wireless lighting control system and service fully developed and supported by RAB. It's powerful and flexible, yet easy to use and install.

Listings

UL Listing:

Suitable for damp locations

IESNA LM-79 & LM-80 Testing:

RAB LED luminaries have been tested by an independent laboratory in accordance with IESNA LM-79 and LM-80, and have received the Department of Energy "Lighting Facts" label.

LED Characteristics

Lifespan:

50,000-hour LED lifespan based on IES LM-80 results and TM-21 calculations.

LEDs:

Long-life, High efficiency, micro-power, surface mount LEDs; binned and mixed for uniform light output and color.

Color Consistency:

3-step MacAdam Ellipse binning to achieve consistent fixture-to-fixture color.

Electrical

Driver:

100-277V, 50/60Hz, THD <15%, Power Factor > 90%, Surge Protection 1 kV, 120V: 0.33A, 208V: 0.21A, 240V: 0.19A, 277V: 0.16A

Dimming Driver:

Driver includes dimming control wiring for 0-10V dimming systems. Requires separate 0-10V DC dimming circuit. Dims as low as 10%.

THD:

5.6% at 120V, 14.4% at 277V

Construction

Ambient Temperature:

Suitable for use in 40°C (104°F) ambient temperatures

IC Rating:

Suitable for insulated ceilings

Lens:

Frosted polystyrene

Cold Weather Starting:

The minimum starting temperature is -4°F/-20°C.

Mounting:

Recessed ceiling

Housing:

Lightweight aluminum housing, steel pan and junction box

Installation:

Standard integral T-bar clips secure the fixture to T-bars and prevent T-system separation.

Finish:

Our environmentally friendly polyester powder coatings are formulated for high-durability and long-lasting color, and contains no VOC or toxic heavy metals.

Green Technology:

Mercury and UV free, and RoHS compliant. Polyester powder coat finish formulated without the use of VOC or toxic heavy metals.

Other

Warranty:

RAB warrants that our LED products will be free from defects in materials and workmanship for a period of five (5) years from the date of delivery to the end user, including coverage of light output, color stability, driver performance and fixture finish.

Dimensions

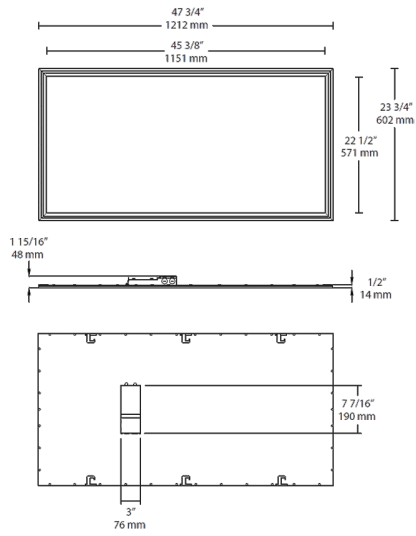

Features

Perfect for shallow plenums

Even and diffuse ambient illumination, ideal for spaces where glare-free lighting is required

0-10V dimmable driver, standard