

product

Versatile Floodlight with hinged lens frame and Hydroformed reflector. Field adjustable vertical and horizontal lamp positions.

Color: White

Weight: 7.6 lbs

Project:

Type:

Prepared By:

Date:

Lamp Info

Type: Triple 32W
 Watts: 32W
 Shape/Size: N/A
 Base: N/A
 ANSI: N/A
 Hours: 12,000
 Lamp Lumens: 2,400
 Efficacy: 67 LPW

Ballast Info

Type: Electronic QT
 120V: 0.3A
 208V: N/A
 240V: N/A
 277V: N/A
 Input Watts: 36W
 Efficiency: 89%

Technical Specifications

Listings

UL Listing:

Suitable for wet locations. Suitable for ground mounting.

Electrical

Photocell:

Button Photocell 120V included. Photocell is only compatible with 120V.

Socket:

Porcelain 4kv Pulse Rated socket with nickel plated screw shell.

Construction

Housing:

Precision die cast aluminum. 1/2" NPS threaded arm with locking swivel.

Reflector:

Hydroformed aluminum. Field adjustable vertical or horizontal.

Lens Gasket:

High temperature tubular silicone set in die cast retaining groove remains in place during relamping.

Lens Frame:

Precision die cast aluminum. Hinged for easy access.

Finish:

Our environmentally friendly polyester powder coatings are formulated for high-durability and long-lasting color, and contains no VOC or toxic heavy metals.

Ground Mounting:

Use the new MPM19 PVC Mighty Post with aluminum cap for sturdy installation.

EPA:

0.6

Other

Country of Origin:

Designed by RAB in New Jersey and assembled in the USA by RAB's IBEW Local 3 workers.

Buy American Act Compliant:

This product is a COTS item manufactured in the United States, and is compliant with the Buy American Act.

Recovery Act (ARRA) Compliant:

This product complies with the 52.225-21 "Required Use of American Iron, Steel, and Manufactured Goods-- Buy American Act-- Construction Materials (October 2010).

Trade Agreements Act Compliant:

This product is a COTS item manufactured in the United States, and is compliant with the Trade Agreements Act.

GSA Schedule:

Suitable in accordance with FAR Subpart 25.4.

Dimensions

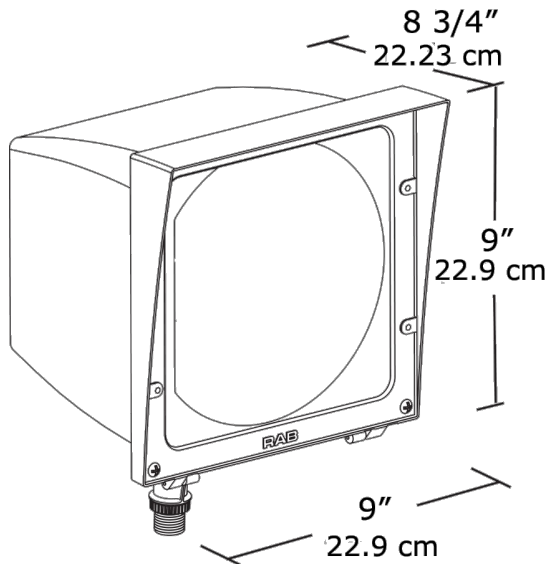

Features

- Fins for heat dissipation extend lamp & ballast tube
- Hinged lens frame is captive during relamping
- Silicone gasket for durable weatherproofing
- Hydroformed reflector is field adjustable to vertical or horizontal lamp positions
- Long life lamp included
- Precision die cast aluminum housing and lens frame with durable polyester powder coating
- EZ Grip locknut matches fixture finish and can be adjusted with fingers, pliers or a screwdriver