



Low-profile vandal-resistant fixture covers the footprint of most traditional canopy lights. Available in flat or drop lens with photo and motion sensor controls.

Color: White

Weight: 11.8 lbs

Project:	Type:
Prepared By:	Date:

Driver Info		LED Info	
Type:	Constant Current	Watts:	75W
120V:	0.85A	Color Temp:	4000K (Neutral)
208V:	N/A	Color Accuracy:	75 CRI
240V:	N/A	L70 Lifespan:	100,000
277V:	N/A	Lumens:	6,943
Input Watts:	75W	Efficacy:	92 LPW
Efficiency:	N/A		

Technical Specifications

Listings

UL Listing:

Suitable for wet locations.

DLC Listed:

This product is on the Design Lights Consortium (DLC) Qualified Products List and is eligible for rebates from DLC Member Utilities.

IESNA LM-79 & LM-80 Testing:

RAB LED luminaires have been tested by an independent laboratory in accordance with IESNA LM-79 and LM-80, and have received the Department of Energy "Lighting Facts" label.

Electrical

Driver:

Class 2, 100-277V, 50-60Hz, 1980mA

THD:

6.1% at 120V, 10.1% at 277V

Construction

Ambient Temperature:

Suitable for use in 40°C (104°F) ambient temperatures.

Cold Weather Starting:

Minimum starting temperature is -40°F/-40°C

Housing:

Die-cast aluminum housing and lens frame with (4) 1/2" NPS side conduit entries and weatherproof rear wire plug and access plate

Mounting:

Ceiling mount to recessed junction with knockout template or directly to ceiling surface, utilizing side conduit entry points.

IP Rating:

Ingress Protection rating of IP66 for dust and water.

Lens:

Vandal-resistant polycarbonate textured opaque for low glare flat lens

Reflector:

Semi-specular, vacuum-metalized polycarbonate

Gaskets:

High-temperature silicone gaskets

Finish:

Our environmentally friendly polyester powder coatings are formulated for high-durability and long-lasting color, and contain no VOC or toxic heavy metals.

Green Technology:

Mercury and UV free, and RoHS compliant. Polyester powder coat finish formulated without the use of VOC or toxic heavy metals.

LED Characteristics

LEDs:

Discreet LEDs on PCB board

Color Stability:

RAB LEDs exceed industry standards for chromatic stability.

Color Uniformity:

RAB's range of CCT (Correlated Color Temperature) follows the guidelines of the American National Standard for Specifications for the Chromaticity of Solid State Lighting (SSL) Products, ANSI C78.377-2011.

Other

Country of Origin:

Designed by RAB in New Jersey and assembled in the USA by RAB's IBEW Local 3 workers.

Buy American Act Compliant:

This product is a COTS item manufactured in the United States, and is compliant with the Buy American Act.

Recovery Act (ARRA) Compliant:

This product complies with the 52.225-21 "Required Use of American Iron, Steel, and Manufactured Goods-- Buy American Act-- Construction Materials (October 2010).

Trade Agreements Act Compliant:

This product is a COTS item manufactured in the United States, and is compliant with the Trade Agreements Act.

GSA Schedule:

Suitable in accordance with FAR Subpart 25.4.

Replacement:

The VANLED 75W replaces up to 200W Metal Halide.

VANLED75NFMSW

Dimensions

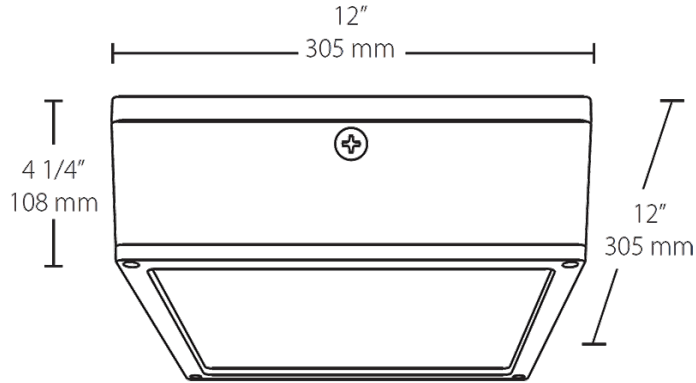

Features

- Fits the footprint of older canopy lights
- Vandal resistant and UV resistant lens
- Ultra-high efficiency
- Clean, contemporary, low-profile design
- Available with drop lens or flat lens
- IP66 rated, keeps dust, bugs and water out
- Photo and motion sensor options available

Ordering Matrix

Family	Watts	Color Temp	Lens	Sensor	Finish	Dimming	Voltage	Photocell
VANLED								
	10 = 10W	Blank = Cool	Blank = Drop lens	Blank = No Sensor	Blank = Bronze	Blank = No Dimming	Blank = 120-277V	Blank = No Photocell
	20 = 20W	Y = Warm	F = Flat lens	MS = Mini Sensor	W = White	/D10 = Dimmable (10W & 20W not available)	/480 = 480V (10W & 20W not available)	/PCS = 120V Swivel
	40 = 40W	N = Neutral						/PCS2 = 277V Swivel
	52 = 52W							/PCS4 = 480V Swivel
	65 = 65W							
	75 = 75W							