



Pole adaptors for ALED Area Lights
Color: Bronze

Weight: 0.5 lbs

Project:	Type:
Prepared By:	Date:

Technical Specifications

Other

Description:

Round pole adaptor 4"

Construction

Compatibility:

AL, ALX, AJ, ALED52, ALED78, ALED104, ALED105, ALED125 and ALED150.

Dimensions

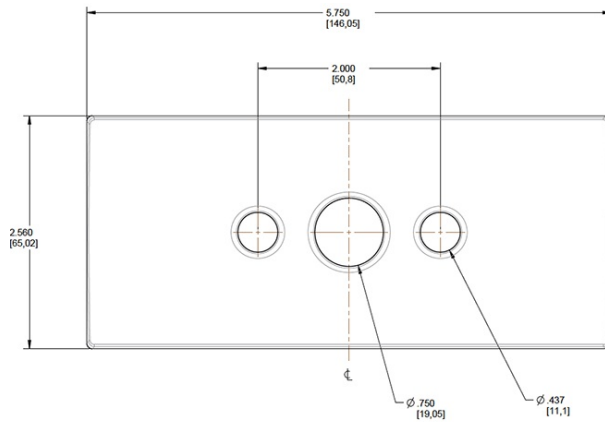

POLE DIA	DIM *A*
3.0"	R 1.50"
3.5"	R 1.75"
4"	R 2.0"
5"	R 2.5"
6"	R 3.0"

Ordering Matrix

Family	Size	Compatibility	Finish
RPA	3 = 3" 35 = 3.5" 4 = 4" 5 = 5"	= ALED52/78/104, AL, ALX, AJ L = ALED10/13/20/26	= Bronze W = White