



Type II distribution wall mount Area Light with 4" arm for use at 10' - 15' height. Fixed mounting at 90° to wall. Lamp supplied.

Color: Bronze

Weight: 20.4 lbs

**Project:**

**Type:**

**Prepared By:**

**Date:**

**Lamp Info**

Type: ED17  
 Watts: 100W  
 Shape/Size: N/A  
 Base: N/A  
 ANSI: N/A  
 Hours: 24,000  
 Lamp Lumens: 9,500  
 Efficacy: 83 LPW

**Ballast Info**

Type: HX-HPF QT  
 120V: 1.3/1.2A  
 208V: .8/.7A  
 240V: .7/.6A  
 277V: .6/.5A  
 Input Watts: 115W  
 Efficiency: 87%

## Technical Specifications

**Listings**

**UL Listing:**

Suitable for wet locations.

**Construction**

**Construction:**

Die cast aluminum housing and door. Tether connects door to housing for safety.

**Reflector:**

High quality hydroformed semi-specular aluminum.

**Finish:**

Our environmentally friendly polyester powder coatings are formulated for high-durability and long-lasting color, and contains no VOC or toxic heavy metals.

**Effective Projected Area:**

EPA = 0.8 With House Side Shield = 1.5

**Other**

**Patents:**

The design of the AJ Area Light is protected by U.S. Patents D579,140, D579,141, D591,445, Canada patents D127,031, D127,040, D127,045, China patents ZL200830143714.3, ZL200830143713.9, ZL200830143712.4, Mexico patents 27395, 28572, 28577 and Taiwan patents D129,808 and D131,622

**Country of Origin:**

Designed by RAB in New Jersey and assembled in the USA by RAB's IBEW Local 3 workers.

**Buy American Act Compliant:**

This product is a COTS item manufactured in the United States, and is compliant with the Buy American Act.

**Recovery Act (ARRA) Compliant:**

This product complies with the 52.225-21 "Required Use of American Iron, Steel, and Manufactured Goods-- Buy American Act-- Construction Materials (October 2010).

**Trade Agreements Act Compliant:**

This product is a COTS item manufactured in the United States, and is compliant with the Trade Agreements Act.

**GSA Schedule:**

Suitable in accordance with FAR Subpart 25.4.

**Electrical**

**Socket:**

HID Porcelain 4KV Pulse rated Medium base. Corrosion resistant screw shell with spring loaded center contact.

**Dimensions**

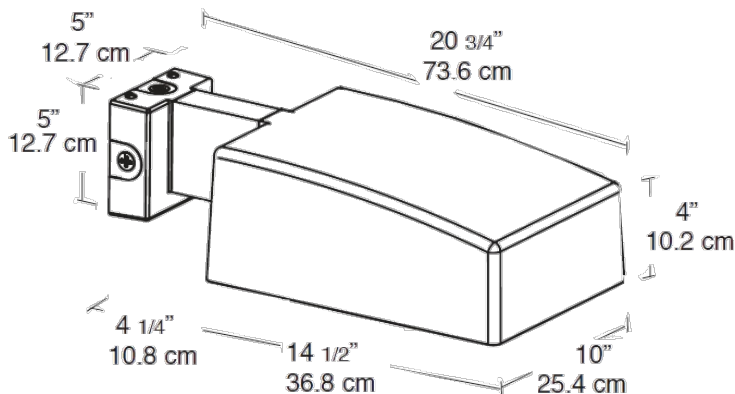

**Features**

- For use at 10' - 15' mounting height
- Sleek design for low EPA
- Heavy duty die cast aluminum housing and door
- 4kv pulse rated socket
- Hydroformed reflector
- Silicone gasket seals optical compartment
- Lamp supplied