



This ultra high efficiency LED garage light delivers up to 118 lumens per Watt. Available in 30, 42 and 55 Watt versions that replace 70 to 175 Watt metal halide fixtures.

Color: Bronze

Weight: 10.6 lbs

Project:	Type:
Prepared By:	Date:

Driver Info		LED Info	
Type:	Constant Current	Watts:	55W
120V:	0.5A	Color Temp:	5000K (Cool)
208V:	0.33A	Color Accuracy:	75 CRI
240V:	0.32A	L70 Lifespan:	100,000
277V:	0.31A	Lumens:	6,085
Input Watts:	59W	Efficacy:	103 LPW
Efficiency:	93%		

Technical Specifications

Listings

UL Listing:

Suitable for wet locations.

DLC Listed:

This product is on the Design Lights Consortium (DLC) Qualified Products List and is eligible for rebates from DLC Member Utilities.

IESNA LM-79 & LM-80 Testing:

RAB LED luminaires have been tested by an independent laboratory in accordance with IESNA LM-79 and LM-80, and have received the Department of Energy "Lighting Facts" label.

Electrical

Drivers:

Constant Current, Class 2 100V - 277V, 50/60 Hz. THD <20%.

Construction

Lens:

Frosted polycarbonate

Gaskets:

High temperature silicone.

IP Rating:

Ingress Protection rating of IP66 for dust and water.

Ambient Temperature:

Suitable for use in 40°C ambient temperatures.

Finish:

Our environmentally friendly polyester powder coatings are formulated for high-durability and long-lasting color, and contains no VOC or toxic heavy metals.

Cold Weather Starting:

Minimum starting temperature is -40°F/-40°C.

Thermal Management:

Superior thermal management with external Air-Flow fins.

Housing:

Die-cast aluminum and sheetmetal housing

Mounting:

Die-cast aluminum backbox with (4) 1/2" conduit openings with plugs. Hinged tether for easy installation and wiring. Also accommodates 1/2" or 3/4" NPS pendants (provided by others).

Lens:

High-transmission and vandal-resistant polycarbonate frosted lens

Reflector:

Specular polycarbonate

Green Technology:

Mercury and UV free, and RoHS compliant. Polyester powder coat finish formulated without the use of VOC or toxic heavy metals.

LED Characteristics

LEDs:

Long-life, high-efficiency surface mount LEDs

Lifespan:

100,000-hour LED lifespan based on IES LM-80 results and TM-21 calculations.

Color Consistency:

7-step MacAdam Ellipse binning to achieve consistent fixture-to-fixture color.

Color Stability:

LED color temperature is warranted to shift no more than 200K in CCT over a 5 year period

Color Uniformity:

RAB's range of CCT (Correlated color temperature) follows the guidelines of the American National Standard for Specifications for the Chromaticity of Solid State Lighting (SSL) Products, ANSI C78.377-2008.

Other

California Title 24:

See PORTO with 0-10V dimming (/D10) driver for a compliant California Title 24.

Warranty:

RAB warrants that our LED products will be free from defects in materials and workmanship for a period of five (5) years from the date of delivery to the end user, including coverage of light output, color stability, driver performance and fixture finish.

Dimensions

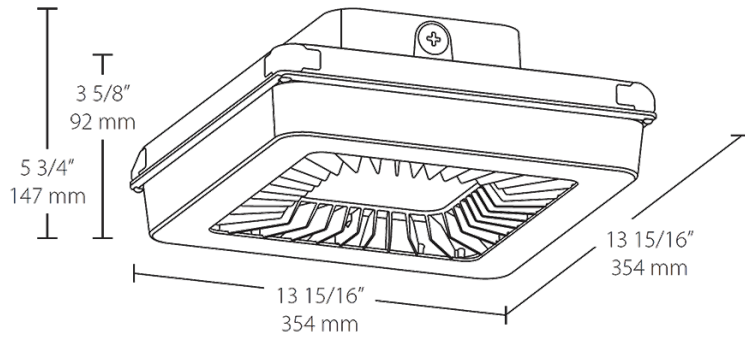

Features

- Ultra-high efficiency
- Pendant or surface mount
- IP 66 rated, keeps water and dust out
- Low glare, vandal-resistant polycarbonate lens
- 20% uplight eliminates "cave effect"
- 100,000-Hour LED lifespan
- 5-year warranty

Ordering Matrix

Family	Watts	Color Temp	Finish	Dimming	Voltage
PRT	30 = 30W 42 = 42W 55 = 55W	Blank = Cool Y = Warm N = Neutral	Blank = Bronze W = White	Blank = No Dimming /D10 = Dimmable	Blank = 120-277V /480 = 480V