



Remodeler Square 4" & 6" White Trim with Black Cone downlights provide an ultra performance, high-end solution for adding recessed lighting to existing ceilings. 90 CRI.

Color: Black cone white trim

Weight: 3.5 lbs

**Project:**

**Type:**

**Prepared By:**

**Date:**

#### Driver Info

Type:	Constant Current
120V:	0.175A
208V:	0.116A
240V:	0.1A
277V:	0.087A
Input Watts:	22W
Efficiency:	93%

#### LED Info

Watts:	20W
Color Temp:	2700K
Color Accuracy:	90 CRI
L70 Lifespan:	100,000
Lumens:	1,236
Efficacy:	57 LPW

## Technical Specifications

### Listings

#### UL Listed:

Suitable for wet locations covered ceiling.

### Optical

#### Photometrics:

Photometrics are based on prorated reports. Contact the RAB Lighting Design department for the most up-to-date data.

#### Optics:

50° beam spread with specular thermoplastic optics and Nanostructure lens technology for smooth light output and high efficiency.

### Electrical

#### Driver:

Provided with Lutron L3DA4U1UKS-HC050 driver, Constant Current, Class 2, 120-277V, 50/60Hz, 500mA, 0.7A, Power Factor 90%, THD ≤ 20% Minimum Operating Temp 32° F (0° C).

#### Dimming Driver:

Lutron Hi-Lume Dimming Driver. See compatibility guide

### LED Characteristics

#### LED:

Long-life, high-output LED module. Binned for natural white light to match incandescent and 3-step MacAdam Ellipse consistency.

#### Lifespan:

100,000-hour LED lifespan based on IES LM-80 results and TM-21 calculations.

#### Correlated Color Temp. (Nominal CCT):

2700K Residential Warm.

#### Color Consistency:

3-step MacAdam Ellipse binning to achieve consistent fixture-to-fixture color.

#### Color Stability:

LED color temperature is warranted to shift no more than 200K in CCT over a 5 year period.

### Construction

#### Ambient Temperature:

Suitable for use in 40°C ambient temperatures.

#### Cold Weather Starting:

The minimum starting temperature is -40°F/-40°C.

#### Trim Ring:

White powder coated die cast trim ring.

#### Trim Cone:

Black square trim cone.

#### Lens:

Nanostructure lens eliminates "hot spots", and helps provide smooth, uniform light and higher efficiency.

#### Junction Box:

Integral junction box with wiring capacity for Min 90°C supply conductors  
2 in 2 out

#### Housing:

Professional-grade, die-cast aluminum construction.

#### Easy Installation:

Easy installation with ceiling clamps.

#### Green Technology:

Mercury and UV free.

### Other

#### Equivalency:

RDLED 20W is equivalent to 100W PAR.

#### Air Tight:

Housing certified Air Tight as per ASTM E283

#### Absolute White™:

A unique binning process designed to match incandescent at each color temperature. It's 3-step consistent, very stable over time and looks the way you expect light to look.

#### California Title 24:

RDLED6S20L complies with 2013 California Title 24 building and electrical codes as a residential indoor fixture. It also complies as a commercial indoor fixture for general spaces when used with a vacancy sensor and Lutron dimming control. Select a vacancy sensor using catalog number LVS800. Lutron dimmer provided by others.

#### Warranty:

RAB warrants that our LED products will be free from defects in materials and workmanship for a period of five (5) years from the date of delivery to the end user, including coverage of light output, color stability, driver performance and fixture finish.

#### Country of Origin:

Designed by RAB in New Jersey and assembled in the USA by RAB's IBEW Local 3 workers.

#### Buy American Act Compliant:

This product is a COTS item manufactured in the United States, and is compliant with the Buy American Act.

## Technical Specifications (continued)

### Other

#### Recovery Act (ARRA) Compliant:

This product complies with the 52.225-21 "Required Use of American Iron, Steel, and Manufactured Goods-- Buy American Act-- Construction Materials (October 2010).

#### Trade Agreements Act Compliant:

This product is a COTS item manufactured in the United States, and is compliant with the Trade Agreements Act.

#### GSA Schedule:

Suitable in accordance with FAR Subpart 25.4.

### Dimensions

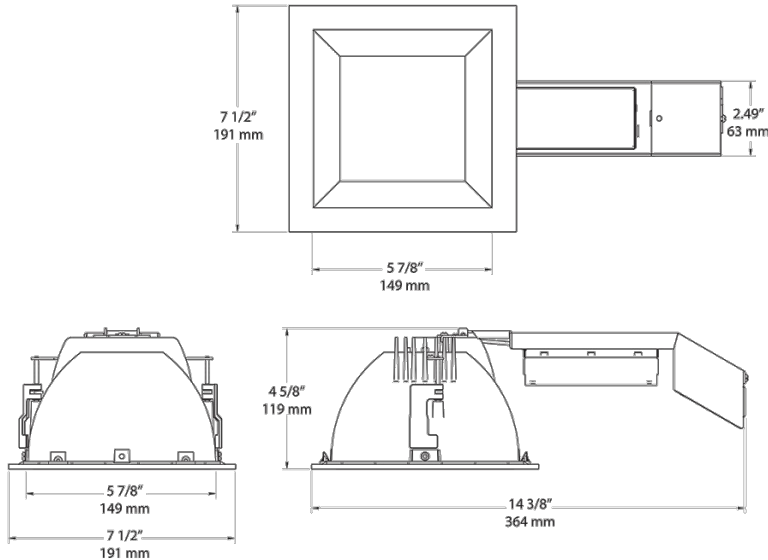

### Features

- High performance, high efficiency alternative to incandescent lighting
- Integrated ceiling clamps make installation fast and secure for ceiling up to 1 1/4" thick
- Nanostructure lens eliminates "hot spots" providing smooth and efficient light
- Low-profile design allows for installation in ceilings with limited space
- Absolute White™ natural light output
- 90 CRI

### Ordering Matrix

Family	Size	Shape	Watts	Dimming Driver	Beam Spread	Color Temp	Cone Color	Trim Color
RDLED	6 = 6" 4 = 4"	S = Square	12 = 12W (4" only) 20 = 20W 26 = 26W (6" only)	= Triac Driver E = ELV Driver L = Lutron Driver F = 120V-277V Driver	50 = 50° 80 = 80° W = Wall Washer	YY = 2700K (Residential Warm) Y = 3000K (Warm) YN = 3500K (Warm Neutral)	B = Black W = White	