



Easy to install 4" and 6" rough-in with die-cast aperture ring, removable driver, thermal protector and adjustable butterfly brackets. This rough-in is designed to make new construction recessed downlighting easy 90 CRI.

Color: N/A

Weight: 5.2 lbs

Project:

Type:

Prepared By:

Date:

Driver Info

Type: Constant Current
 120V: 0.253A
 208V: 0.168A
 240V: 0.146A
 277V: 0.126A
 Input Watts: 0W
 Efficiency: N/A

LED Info

Watts: 26W
 Color Temp: Sold Separately
 Color Accuracy: 90 CRI
 L70 Lifespan: N/A
 Lumens: N/A
 Efficacy: N/A

Technical Specifications

Listings

UL Listed:

Suitable for wet locations covered ceiling.

Optical

Photometrics:

Photometrics are based on prorated reports. Contact the RAB Lighting Design department for the most up-to-date data.

Construction

Housing Component:

This component must be ordered with New Construction Square Trim Module in order to make a complete fixture.

Ambient Temperature:

Suitable for use in 40°C ambient temperatures.

Cold Weather Starting:

The minimum starting temperature is -40°F/-40°C.

Aperture Size:

6" Rough-In.

Drop Ceiling Installation:

NDLED can be installed in drop ceiling tiles when using optional c-channel bars and following local construction codes.

Junction Box:

Integral junction box with wiring capacity for Min 90°C supply conductors
 4 in 4 out

Butterfly Brackets:

The Butterfly bracket allows to mount with the following 1/4 x 1/2" bar stock, C Channel, 1/2" conduit, or nailer bars.

Easy Installation:

The EZConnector makes installation easy.

Thermal Protector:

Thermal protector included. Disables power if temperature exceeds safe operation levels.

Electrical

Driver:

Electronic Low Voltage, Constant Current, Class 2, 120-277V, 50/60Hz, 350mA, 120V 0.17A 277V 0.09A, Power Factor 99.4%, THD ≤ 10%.

Dimming Driver:

Electronic Low Voltage compatible dimmer with dimming as low as 5%.

Other

Air Tight:

Housing certified Air Tight as per ASTM E283

California Title 24:

ND6S26E complies with 2013 California Title 24 building and electrical codes as a residential indoor fixture. It also complies as a commercial indoor fixture for general spaces when used with a vacancy sensor and ELV dimming control. Select a vacancy sensor using catalog number LVS800. ELV dimmer provided by others.

Warranty:

RAB warrants that our LED products will be free from defects in materials and workmanship for a period of five (5) years from the date of delivery to the end user, including coverage of light output, color stability, driver performance and fixture finish.

Country of Origin:

Designed by RAB in New Jersey and assembled in the USA by RAB's IBEW Local 3 workers.

Buy American Act Compliant:

This product is a COTS item manufactured in the United States, and is compliant with the Buy American Act.

Recovery Act (ARRA) Compliant:

This product complies with the 52.225-21 "Required Use of American Iron, Steel, and Manufactured Goods-- Buy American Act-- Construction Materials (October 2010).

Trade Agreements Act Compliant:

This product is a COTS item manufactured in the United States, and is compliant with the Trade Agreements Act.

GSA Schedule:

Suitable in accordance with FAR Subpart 25.4.

LED Characteristics

Color Accuracy:

90 CRI

Dimensions

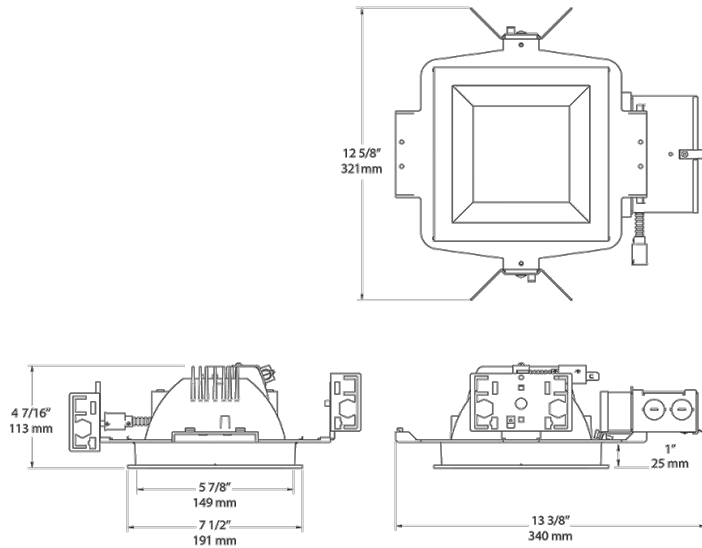

Features

- Butterfly bracket allows mounting with bar stock, "C" channel, 1/2" conduit or nailer bars
- Low-profile design allows for installation in ceilings with limited space
- Sturdy design with die cast aperture frame
- 90 CRI

Ordering Matrix

Family	Type	Size	Shape	Watts	Dimming Driver	Battery Backup
ND	^	6	S	26	E	^
	Blank = Standard IC = Insulation Contact (IC)	4 = 4" 6 = 6"	S = Square	12 = 12W 20 = 20W 26 = 26W	Blank = Triac Driver E = ELV Driver L = Lutron Driver F = 120V-277V Driver	Blank = No Battery Backup /E2 = 120-277V Backup