



LED retrofit downlights are perfect for updating existing recessed lighting without changing the fixture. Equivalent to 50W Par.

Color: White

Weight: 1.4 lbs

Project:	Type:
Prepared By:	Date:

Driver Info		LED Info	
Type:	Constant Current	Watts:	8W
120V:	0.08A	Color Temp:	2700K
208V:	N/A	Color Accuracy:	84 CRI
240V:	N/A	L70 Lifespan:	100,000
277V:	N/A	Lumens:	523
Input Watts:	9W	Efficacy:	61 LPW
Efficiency:	94%		

Technical Specifications

Listings

UL Listed:

Suitable for damp locations.

IESNA LM-79 & LM-80 Testing:

RAB LED luminaires have been tested by an independent laboratory in accordance with IESNA LM-79 and LM-80, and have received the Department of Energy "Lighting Facts" label.

Electrical

Driver:

Innovative integrated driver technology with 120V TRIAC and ELV dimming.

Surge Protection:

2.5KV

Construction

Lens:

Polycarbonate diffusion lens for smooth light output.

Compatibility:

Low-profile design for maximum compatibility with many 5" incandescent recessed downlight housings.

Ambient Temperature:

Suitable for use in 40°C ambient temperatures.

Cold Weather Starting:

The minimum starting temperature is -22°F/-30°C.

Adapters:

Edison E26 medium base adapter included. GU24 socket adapter sold separately.

Installation:

Pre-installed Torsion springs and optional friction clips are both included to aid in attaching and securing the 5" DLED to the incandescent housing.

Finish:

Our environmentally friendly polyester powder coatings are formulated for high-durability and long-lasting color, and contains no VOC or toxic heavy metals.

Green Technology:

Mercury and UV free, and RoHS compliant.

LED Characteristics

Lifespan:

100,000-hour LED lifespan based on IES LM-80 results and TM-21 calculations.

LEDs:

High-output, long-life LEDs with 3 step binning and integrated driver technology.

Color Consistency:

3-step MacAdam Ellipse binning to achieve consistent fixture-to-fixture color.

Other

ENERGY STAR:

This product is ENERGY STAR® qualified.

Equivalency:

8W replaces 50W Par.

California Title 24:

DLED5R8 complies with 2013 California Title 24 building and electrical codes as a commercial indoor fixture for general spaces when used with a vacancy sensor and TRIAC dimming control. Select a vacancy sensor using catalog number LVS800. TRIAC dimmer provided by others.

Warranty:

RAB warrants that our LED products will be free from defects in materials and workmanship for a period of five (5) years from the date of delivery to the end user, including coverage of light output, color stability, driver performance and fixture finish.

Optical

Spacing Criteria:

0-180° (along): 1.13

Dimensions

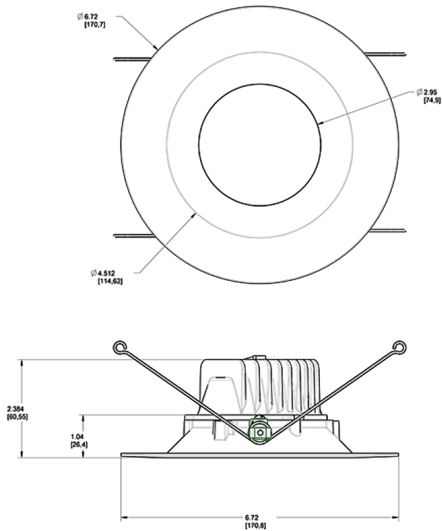

Features

- Savings of up to \$1500 over 100,000 hrs
- 8W replaces 50W PAR
- Dimmable down to industry-leading 5%
- Low profile design for easy fit and installation
- 100,000-Hour LED lifespan

Photometrics

candlepower distribution

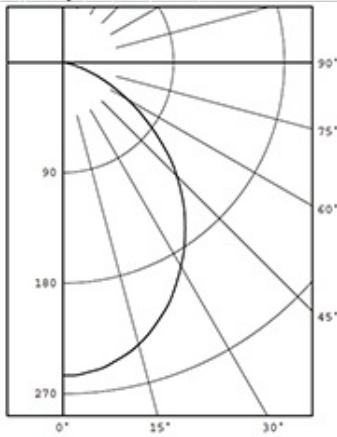

candela distribution

vertical deg.	candelas
0	255
5	253
15	238
25	210
35	173
45	131
55	83
65	41
75	9
85	1
90	0

LUMENS PER WATT: 61.4

cone of light

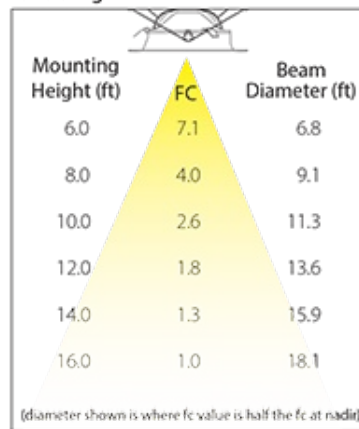

zonal lumen summary

zone	lumens	% fix.
0- 30	187	35.8
0- 40	295	56.4
0- 60	471	89.9
0- 90	523	100.0
90-180	0	0.0
0-180	523	100.0

luminance (candela/M²)

degrees	avg. luminance
45	18567
55	14503
65	9723
75	3485
85	1150

Ordering Matrix

Family	Size	Shape	Watts	Color Temp	Type
DLED	5 = 5"	R = Round	8 = 8W	YY = 2700K (Residential Warm) Y = 3000K (Warm) YN = 3500K (Warm Neutral)	Blank = Without Baffle /BAF = With Baffle