



LED High Bay fixture ideal for large indoor spaces, including warehouses, gymnasiums and distribution centers that require mounting heights from 15 to 50 feet. Available in 150, 185, 225 and 400 Watt versions with replacements up to 1000 Watt HID fixtures. Includes built in support for Lightcloud, RAB's commercial wireless lighting control system. Lightcloud is a commercial wireless lighting control system and service fully developed and supported by RAB. It's powerful and flexible, yet easy to use and install.

Color: White

Weight: 20.7 lbs

Project:	Type:
Prepared By:	Date:

Driver Info		LED Info	
Type:	Constant Current	Watts:	225W
120V:	1.68A	Color Temp:	5000K
208V:	1.02A	Color Accuracy:	76 CRI
240V:	0.88A	L70 Lifespan:	100000
277V:	0.74A	Lumens:	27156
Input Watts:	200W	Efficacy:	136 LPW
Efficiency:	N/A		

Technical Specifications

Lightcloud

Lightcloud Installed:

Lightcloud is a commercial wireless lighting control system and service fully developed and supported by RAB. It's powerful and flexible, yet easy to use and install.

Listings

UL Listing:

Suitable for damp locations

IESNA LM-79 & LM-80 Testing:

RAB LED luminaires have been tested by an independent laboratory in accordance with IESNA LM-79 and LM-80, and have received the Department of Energy "Lighting Facts" label.

LED Characteristics

Lifespan:

100,000-hour LED lifespan based on IES LM-80 results and TM-21 calculations.

LEDs:

Long-life, high-efficiency surface mounting LEDs

Color Stability:

LED Color temperature is warrantied to shift no more than 200K in CCT over a 5 year period.

Color Uniformity:

RAB's range of CCT (Correlated Color Temperature) follows the guidelines of the American National Standard for Specifications for the Chromaticity of Solid State Lighting (SSL) Products, ANSI C78.377-2015.

Electrical

Driver:

Constant Current, Class 2, 120-277V, 50/60Hz, 120V: 1.68A, 208V: 1.02A, 240V: 0.88A, 277V 0.74A

Dimming Driver:

Driver includes dimming control wiring for 0-10V dimming systems. Requires separate 0-10V DC dimming circuit. Dims as low as 10%.

THD:

2.7% at 120V, 6.8% at 277V

Power Factor:

99.9% at 120V, 95.3% at 277V

Construction

Ambient Temperature:

Suitable for use 12 hours a day, 6 days a week in 55°C (131°F). Suitable for 24/7 use in ambient temperatures up to 40°C (104°F).

Housing:

Extruded aluminum

Lens:

High-transmittance polystyrene

Reflector:

Specular, high-reflectance aluminum with 95% reflectivity

Mounting:

V hooks (chain by others)

Finish:

Formulated for high-durability and long lasting color.

Green Technology:

Mercury and UV free. RoHS compliant components. Polyester powder coat finish formulated without the use of VOC or toxic heavy metals.

Recommended Mounting Height:

Up to 50 ft.

Other

Equivalency:

Equivalent to 400W Metal Halide

Warranty:

RAB warrants that our LED products will be free from defects in materials and workmanship for a period of five (5) years from the date of delivery to the end user, including coverage of light output, color stability, driver performance and fixture finish.

California Title 24:

See RAIL with Multi-Level sensor (/WS2 or /WS4) for a compliant California Title 24.

Buy American Act Compliance:

RAB values USA manufacturing! Upon request, RAB may be able to manufacture this product to be compliant with the Buy American Act (BAA). Please contact customer service to request a quote for the product to be made BAA compliant.

RAIL225W/D10/LC



Dimensions

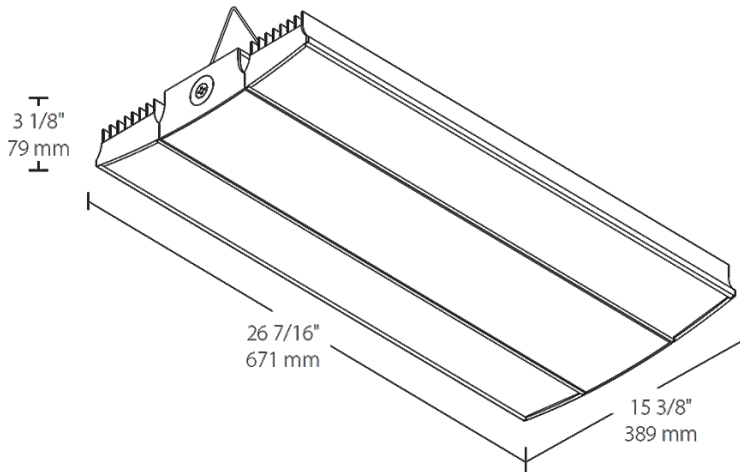

Features

- Ideal for large spaces
- Ultra-high efficacy
- Up to 60% less energy usage than equivalent metal halide fixtures
- 100,000 hour lifespan, virtually maintenance free operation
- 0-10V driver for variable dimming down to 10%
- Built in support Lightcloud™
- Easy setup - simply power on, confirm device connectivity and call 844-LIGHTCLOUD

Ordering Matrix

Family	Mounting	Wattage	Color Temp	Finish	Voltage	Dimming	Control Options
RAIL		225		W		/D10	/LC
	Blank = Standard P = Pendant	225 = 225W 185 = 185W 150 = 150W 95 = 95W	Blank = 5000K (Cool) N = 4000K (Neutral) YN = 3500K (Warm Neutral)	W = White	Blank = 120-277V /480 = 480V	/D10 = 0-10V Dimming	Blank = No Controls /BL = Bi-Level Control (120-277V only) /WS2 = Multi-Level Motion Sensor 20 ft /WS4 = Multi-Level Motion Sensor 40 ft /LOS = LOSBAY800 Sensor (120-277V only) /E2 = Emergency Battery Backup (120-277V only) /LC = Lightcloud Controller (120-277V only) /LCS = Lightcloud Highbay Sensor (120-277V only)