



Two adjustable 13W LED floodlights. Equivalent to 2x75W BR30/halogen/wide floods. Diffusion lens optimizes light output without glare.

Color: Black

Weight: 5.0 lbs

<b>Project:</b>	<b>Type:</b>
<b>Prepared By:</b>	<b>Date:</b>

Driver Info		LED Info	
Type:	Constant Current	Watts:	26W
120V:	0.22A	Color Temp:	5000K
208V:	N/A	Color Accuracy:	83 CRI
240V:	N/A	L70 Lifespan:	60000
277V:	N/A	Lumens:	2338
Input Watts:	27W	Efficacy:	87 LPW
Efficiency:	96%		

## Technical Specifications

### Listings

#### UL Listing:

Suitable for wet locations. Suitable for mounting within 4 feet of the ground.

#### IESNA LM-79 & LM-80 Testing:

RAB LED luminaires have been tested by an independent laboratory in accordance with IESNA LM-79 and LM-80, and have received the Department of Energy "Lighting Facts" label.

### Electrical

#### Driver:

120V driver, 50/60/ Hz, 0.22A, 228mA

#### THD:

11.8% at 120V

#### Power Factor:

99.3% at 120V

### Optical

#### NEMA Type:

6H x 6V Beam Spread

### Construction

#### Cold Weather Starting:

Minimum starting temperature is -40°C (-40°F)

#### Maximum Ambient Temperature:

Suitable for use in 40°C (104°F) ambient temperatures

#### Housing:

Precision die-cast aluminum housing, lens frame and mounting arm

#### Reflector:

Vacuum-metallized polycarbonate

#### Lens:

Diffused glass for smooth, even light distribution

#### Mounting:

Pre-Assembled and wired for easy mounting EZ Hang hook. Compatible with round and rectangular surface mount boxes as well as recessed boxes.

#### Gaskets:

High-temperature silicone gaskets

#### Finish:

Our environmentally friendly polyester powder coatings are formulated for high-durability and long-lasting color, and contain no VOC or toxic heavy metals.

#### Green Technology:

Mercury and UV free. RoHS compliant components. Polyester powder coat finish formulated without the use of VOC or toxic heavy metals.

### LED Characteristics

#### LEDs:

Long-life, high-efficiency surface mounting LEDs

#### Color Uniformity:

RAB's range of CCT (Correlated Color Temperature) follows the guidelines of the American National Standard for Specifications for the Chromaticity of Solid State Lighting (SSL) Products, ANSI C78.377-2017.

### Other

#### Equivalency:

Equivalent to 2x75W halogen BR30 wide flood.

#### 5 Yr Limited Warranty:

Fixture operation and paint finish are covered for a period of 5 years.

#### Buy American Act Compliance:

RAB values USA manufacturing! Upon request, RAB may be able to manufacture this product to be compliant with the Buy American Act (BAA). Please contact customer service to request a quote for the product to be made BAA compliant.

# LES2X13B

## Dimensions

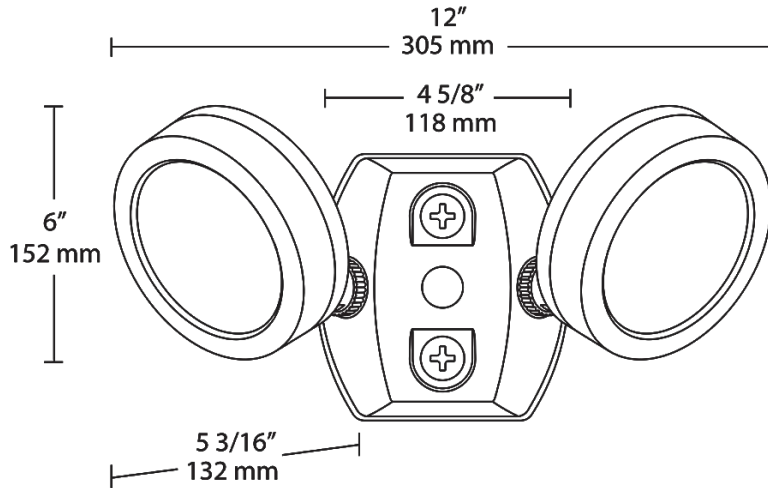

## Features

- Equivalent to two 75W halogen BR30 wide floods
- 6H x 6V beam distribution delivers ample light
- Diffused lens for smooth, even light distribution
- Adjustable knuckle
- 60,000-Hour LED lifespan

## Ordering Matrix

Family	Wattage	Color Temp	Finish
LES	2X13 2x13 = 2 x 13W	Blank = 5000K (Cool) N = 4000K (Neutral) Y = 3000K (Warm)	B Blank = Bronze W = White B = Black VG = Verde Green