



Bullet shape die cast aluminum flood with spotlighting for over 40 feet away. 13 Watt LED High Performance Light Engine.

Color: Verde green

Weight: 4.6 lbs

Project:	Type:
Prepared By:	Date:

Driver Info		LED Info	
Type:	Constant Current	Watts:	13W
120V:	0.12A	Color Temp:	3000K
208V:	0.09A	Color Accuracy:	81 CRI
240V:	0.08A	L70 Lifespan:	100000
277V:	0.07A	Lumens:	1,089
Input Watts:	14W	Efficacy:	76 LPW
Efficiency:	91%		

Technical Specifications

Listings

UL Listing:

Suitable for wet locations. Suitable for ground mounting.

IESNA LM-79 & IESNA LM-80 Testing:

RAB LED luminaires have been tested by an independent laboratory in accordance with IESNA LM-79 and 80, and have received the Department of Energy "Lighting Facts" label.

LED Characteristics

Lifespan:

100,000-hour LED lifespan based on IES LM-80 results and TM-21 calculations.

LEDs:

13 Watt high output, long-life LED.

Color Consistency:

3-step MacAdam Ellipse binning to achieve consistent fixture-to-fixture color.

Color Stability:

LED color temperature is warrantied to shift no more than 200K in CCT over a 5 year period.

Color Accuracy:

87 CRI

Color Temperature (Nominal CCT):

3000K

Color Uniformity:

RAB's range of CCT (Correlated Color Temperature) follows the guidelines of the American National Standard for (SSL) Products, ANSI C78.377-2015.

Optical

Spotlight Distribution:

Beam Angle of 11° and Field Angle of 24° enables the HSLED to produce a very narrow spot distribution.

Lumen Maintenance:

100,000 hours Life Based on LM-80 Tests.

Fixture Efficacy:

36 Lumens per Watt

NEMA Type:

2H x 2V Beam Spread.

Electrical

Driver:

Constant Current, Class 2, 100-277V, 50-60Hz, 100-240VAC 0.3-0.15A, 277VAC 0.15A.

THD:

21.1% at 120V

Surge Protection:

4kV

Dimming Driver:

Driver includes dimming control for 0-10V dimming systems. Requires separate 0-10V DC dimming circuit. Dims as low as 10%.

Construction

Ambient Temperature:

Suitable for use in 40°C ambient temperatures.

Cold Weather Starting:

The minimum starting temperature is -40°C/-40°F

Thermal Management:

Cast aluminum patent pending Thermal Management system for optimal heat sinking. The HSLED is designed for cool operation, most efficient output and maximum LED life by minimizing LED junction temperature.

Housing:

Precision die-cast aluminum housing, hood and mounting arm.

Gaskets:

High Temperature Silicone.

Finish:

Our environmentally friendly polyester powder coatings are formulated for high-durability and long-lasting color, and contains no VOC or toxic heavy metals.

Green Technology:

Mercury and UV free, and RoHS compliant.

Other

Warranty:

RAB warrants that our LED products will be free from defects in materials and workmanship for a period of five (5) years from the date of delivery to the end user, including coverage of light output, color stability, driver performance and fixture finish.

California Title 24:

HSLED13 complies with 2013 California Title 24 building and electrical codes as a commercial outdoor non-pole-mounted fixture < 30 Watts when used with a photosensor control. Select catalog number PCS900(120V) or PCS900/277 to order a photosensor.

Technical Specifications (continued)

Other

Patents:

The design of the HSLED is protected by Taiwan Patent 01510965 and patents pending in US, Canada, China, and Mexico.

Country of Origin:

Designed by RAB in New Jersey and assembled in the USA by RAB's IBEW Local 3 workers.

Buy American Act Compliant:

This product is a COTS item manufactured in the United States, and is compliant with the Buy American Act.

Recovery Act (ARRA) Compliant:

This product complies with the 52.225-21 "Required Use of American Iron, Steel, and Manufactured Goods-- Buy American Act-- Construction Materials (October 2010).

Trade Agreements Act Compliant:

This product is a COTS item manufactured in the United States, and is compliant with the Trade Agreements Act.

GSA Schedule:

Suitable in accordance with FAR Subpart 25.4.

Dimensions

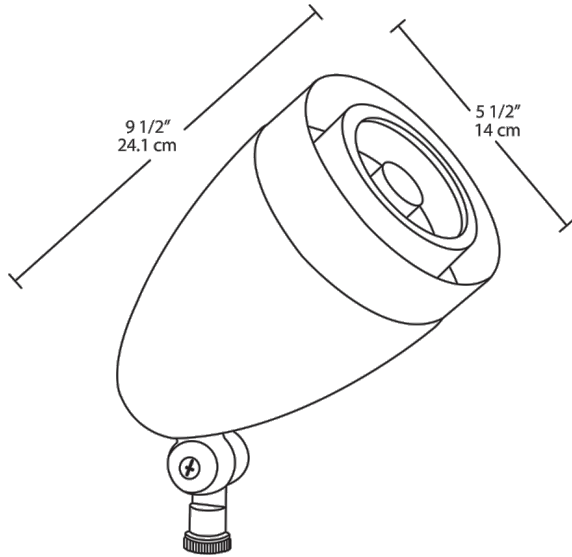

Features

- Spot lighting for over 40 feet away
- Perfect for flag lighting
- NEMA type - 2H x 2V
- Available in four colors
- 100,000-hour life based on LM-80 tests
- 5- year LED warranty