



Ultra high output, high efficiency LED floodlight with NEMA Types: 7H x 6V, 6H x 4V, 4H x 6V, 5H x 5V and 3H x 3V. Patent Pending airflow technology ensures long LED and driver lifespan. Use for general and security lighting for large areas, building facades, signs and landscapes.

Color: White

Weight: 66.1 lbs

<b>Project:</b>	<b>Type:</b>
<b>Prepared By:</b>	<b>Date:</b>

Driver Info		LED Info	
Type:	Constant Current	Watts:	200W
120V:	N/A	Color Temp:	3000K
208V:	N/A	Color Accuracy:	81 CRI
240V:	N/A	L70 Lifespan:	100000
277V:	N/A	Lumens:	21,590
Input Watts:	205W	Efficacy:	105 LPW
Efficiency:	98%		

## Technical Specifications

### Listings

#### UL Listing:

Suitable for wet locations. Suitable for ground mounting.

#### IESNA LM-79 & LM-80 Testing:

RAB LED luminaires have been tested by an independent laboratory in accordance with IESNA LM-79 and LM-80, and have been received the Department of Energy "Lighting Facts" label.

### Electrical

#### Drivers:

Constant Current, 700mA, 50/60 Hz, 347-480V, 4 kV surge protection, 480V: 0.45A, THD <20%, Power Factor: 99%

#### Ballast Volts:

480V

#### Photocell:

480V Button Photocell Included. Photocell is only compatible with 480V.

### Optical

#### NEMA Type:

NEMA Beam Spread of 3H x 3V

### LED Characteristics

#### Lifespan:

100,000-hour LED lifespan based on IES LM-80 results and TM-21 calculations.

#### LEDs:

Multip-chip, high-output, long-life LEDs

#### Color Consistency:

3-step MacAdam Ellipse binning to achieve consistent fixture-to-fixture color.

#### Color Stability:

LED color temperature is warranted to shift no more than 200K in CCT over a 5 year period.

#### Color Uniformity:

RAB's range of CCT (Correlated Color Temperature) follows the guidelines of the American National Standard for Specifications for the Chromaticity of Solid State Lighting (SSL) Products, ANSI C78.377-2011.

### Construction

#### IP Rating:

Ingress Protection rating of IP66 for dust and water.

#### Ambient Temperature:

Suitable for use in 40°C (104°F) ambient temperatures

#### Effective Projected Area:

EPA = 4

#### Cold Weather Starting:

The minimum starting temperature is -40°C/-40°F

#### Thermal Management:

Superior thermal management with external Air-Flow fins.

#### Housing:

Die-cast aluminum housing and door frame

#### Mounting:

Heavy-duty Slipfitter for 2 3/8"OD pipe.

#### Reflector:

Specular and semi-specular vacuum metalized polycarbonate

#### Gaskets:

High-temperature silicone gaskets

#### Finish:

Our environmentally friendly polyester powder coatings are formulated for high-durability and long-lasting color, and contains no VOC or toxic heavy metals.

#### Green Technology:

Mercury and UV free, and RoHS compliant. Polyester powder coat finish formulated without the use of VOC or toxic heavy metals.

### Other

#### California Title 24:

See FXLED200SF/480/PCS4 (480V) for a 2013 California Title 24 compliant product. Any additional component requirements will be listed in the Title 24 section under technical specifications on the product page.

#### Replacement:

The FXLED200 replaces 400W Metal Halide Floodlights.

#### Warranty:

RAB warrants that our LED products will be free from defects in materials and workmanship for a period of five (5) years from the date of delivery to the end user, including coverage of light output, color stability, driver performance and fixture finish.

#### Country of Origin:

Designed by RAB in New Jersey and assembled in the USA by RAB's IBEW Local 3 workers.

## Technical Specifications (continued)

### Other

#### Buy American Act Compliant:

This product is a COTS item manufactured in the United States, and is compliant with the Buy American Act.

#### Recovery Act (ARRA) Compliant:

This product complies with the 52.225-21 "Required Use of American Iron, Steel, and Manufactured Goods-- Buy American Act-- Construction Materials (October 2010).

#### Trade Agreements Act Compliant:

This product is a COTS item manufactured in the United States, and is compliant with the Trade Agreements Act.

#### GSA Schedule:

Suitable in accordance with FAR Subpart 25.4.

## Dimensions

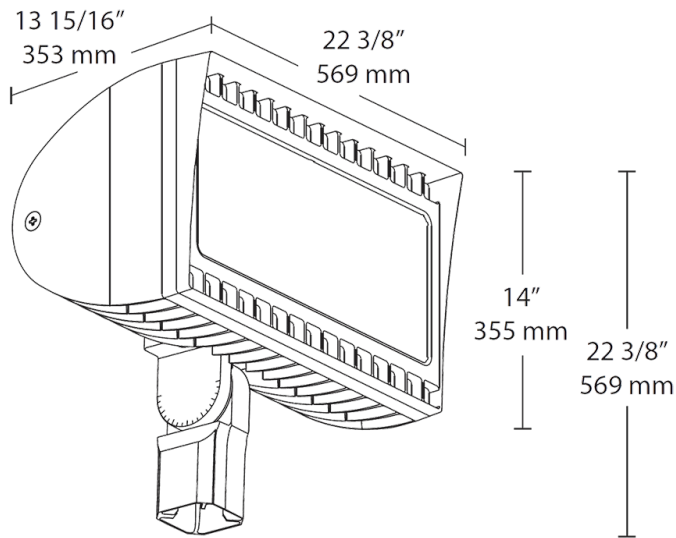

## Features

- 200W replaces 400 MH floodlights
- 100,000-hour LED lifespan
- 5-year No Compromise Warranty

## Ordering Matrix

Family	Watts	Mount	Color Temp	Beam Spread	Finish	Dimming	Voltage	Photocell	Bi-Level
FXLED	200 = 200W	SF = Slipfitter T = Trunnion	Y = 3000K (Warm) N = 4000K (Neutral)	B64 = 6H x 4V B55 = 5H x 5V B46 = 4H x 6V B44 = 4H x 4V B33 = 3H x 3V	W = White	/D10 = Dimmable	/480 = 480V	/PCS = 120V Swivel /PCS2 = 277V Swivel /PCS4 = 480V Swivel /PCT = 120-277V Twistlock /PCT4 = 480V Twistlock	/BL = Bi-Level