



This 78W spotlight combines high lumen output and a concentrated narrow beam distribution to illuminate objects up to 80 feet away with brilliant precision. Ideal for lighting large flags, tall building facades and signage.

Color: Bronze

Weight: 27.5 lbs

Project:	Type:
Prepared By:	Date:

Driver Info		LED Info	
Type:	Constant Current	Watts:	78W
120V:	0.82A	Color Temp:	4000K (Neutral)
208V:	N/A	Color Accuracy:	82 CRI
240V:	N/A	L70 Lifespan:	100,000
277V:	N/A	Lumens:	5,587
Input Watts:	89W	Efficacy:	63 LPW
Efficiency:	88%		

Technical Specifications

Other

EZLED78 with Photocell:

120V Swivel Photocell Included. Photocell is only compatible with 120V.

Patents:

The design of EZLED is protected by patents in U.S. Pat D679,856, and pending patents in Canada, China, Taiwan and Mexico.

Country of Origin:

Designed by RAB in New Jersey and assembled in the USA by RAB's IBEW Local 3 workers.

Buy American Act Compliant:

This product is a COTS item manufactured in the United States, and is compliant with the Buy American Act.

Recovery Act (ARRA) Compliant:

This product complies with the 52.225-21 "Required Use of American Iron, Steel, and Manufactured Goods-- Buy American Act-- Construction Materials (October 2010).

Trade Agreements Act Compliant:

This product is a COTS item manufactured in the United States, and is compliant with the Trade Agreements Act.

GSA Schedule:

Suitable in accordance with FAR Subpart 25.4.

Listings

UL Listing:

Suitable for wet locations. Suitable for ground mounting..

IESNA LM-79 & LM-80 Testing:

RAB LED luminaires have been tested by an independent laboratory in accordance with IESNA LM-79 and LM-80, and have received the Department of Energy "Lighting Facts" label.

Construction

IP Rating:

Ingress Protection rating of IP66 for dust and water.

Effective Projected Area:

EPA = 1.2

Cold Weather Starting:

Minimum starting temperature is -40°F/-40°C.

Ambient Temperature:

Suitable for use in 40°C (104°F) ambient temperatures.

Thermal Management:

Superior thermal management with external Air-Flow fins.

Housing:

Precision die-cast aluminum housing and door frame.

Mounting:

Trunnion mount with cord (18-3AWG STOOW 600V 105° wet location rated 3 ft.).

Lens:

Tempered glass.

Reflector:

Vacuum-metalized, specular thermoplastic.

Gaskets:

High-temperature silicone.

Finish:

Our environmentally friendly polyester powder coatings are formulated for high-durability and long-lasting color, and contains no VOC or toxic heavy metals.

Green Technology:

Mercury and UV free, and RoHS compliant.

LED Characteristics

LEDs:

Three multi-chip, high-output, long-life LEDs.

Lifespan:

100,000-hour LED lifespan based on IES LM-80 results and TM-21 calculations.

Color Consistency:

3-step MacAdam Ellipse binning to achieve consistent fixture-to-fixture color.

Color Stability:

LED color temperature is warranted to shift no more than 200K in CCT over a 5 year period.

Color Uniformity:

RAB's range of CCT (Correlated Color Temperature) follows the guidelines of the American National Standard for Specifications for the Chromaticity of Solid State Lighting (SSL) Products, ANSI C78.377-2011.

Technical Specifications (continued)

Electrical

Driver:

3x26W drivers Constant current, Class2, 100-277V.
50/60 Hz, 6KV Surge Protection, 720mA, 100-277V
0.4A, Power Factor 99%.

THD:

13.5% at 120V

Optical

NEMA Type:

NEMA Beam Spread of 4H x 4V

Dimensions

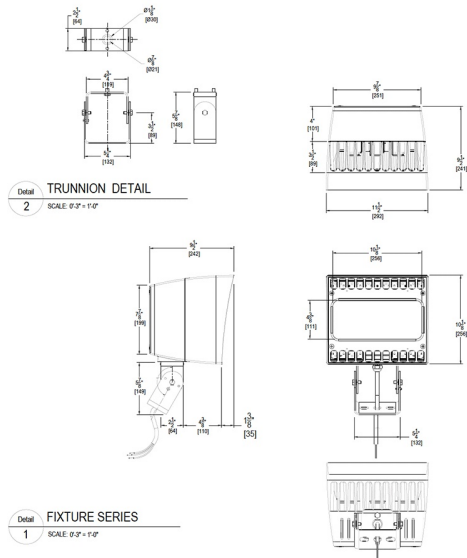

Features

- High powered narrow beam spotlight
- Illuminates objects at a distance of 80 feet
- Available in NEMA type 3H x 3V and 4H x 4V
- Trunnion or slipfitter mounting options available
- Outperforms equivalent MH fixtures

Ordering Matrix

Family	Watts	Mount	Color Temp	Beam Spread	Finish	Photocell
EZLED	78 = 78W	SF = Slipfitter	Blank = Cool Y = Warm N = Neutral	Blank = 7H x 6V B44 = 4H x 4V B55 = 5H x 5V	Blank = Bronze W = White	Blank = No Photocell /PC = 120V Button /PCS = 120V Swivel /PC2 = 277V Button /PCS2 = 120V Swivel