



FF50W/PC



JOB NAME: _____
 DATE: _____
 TYPE: _____

DESCRIPTION

Compact, tough and good looking cast aluminum housing with hinged framed glass lens. Integra Hood glare shield and stainless steel clip. 35 to 150 watt HPS Metal Halide Pulse Start. 50 & 70 watt with 120v reactor ballast or 100W with 277V NPF ballast. Lamp supplied.

SPECIFICATIONS

Finish:

Chip and fade resistant polyester powder coating

Housing:

Precision die cast aluminum, 1/2" NPS threaded arm with locking swivel fits all standard mounting boxes

Lens Gasket:

High temperature tubular silicone set in die cast retaining groove remains in place during relamping

Lens:

Thermal tempered shock resistant glass

Reflector:

Anodized semi-specular aluminum

Socket:

Glazed porcelain 4kv pulse rated with nickel plated screw shell and spring contacts

Sockets:

Porcelain with all copper current carrying components

UL Listing:

Suitable for wet locations. Suitable for mounting within 4' of the ground

EPA:

0.43

Patents:

Pat. D420,458

Photocontrol:

Button Photocontrol installed and wired for 120V

Color:

White

Weight:

6.2

DIMENSIONS

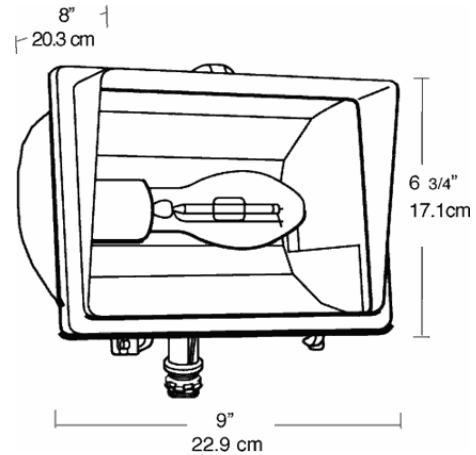

PHOTOMETRIC

150w HPS @ 10' Mounting Height
 Aimed 30° below horizontal

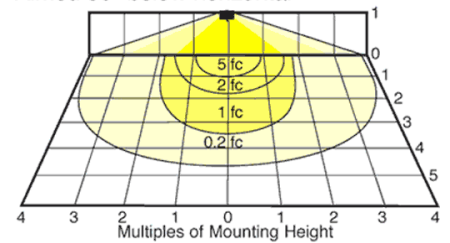

Mounting Height	Multiplier
8'	1.6
10'	1.0
12'	.7
16'	.4
20'	.25

Watts	Multiplier	HPS	MH	CFL
150	1			
100	.6	.6		
70	.4	.4		
50	.3	.2		
35	.15			
42			.2	

ORDERING INFORMATION

High Pressure Sodium
 Lamp supplied with fixture

Total Watts	Lamp Type	Lamp Base	Ballast
50	ED17	Medium	R-NPF 120V

Starting Amps/ Operating Amps			
120V	208V	240V	277V
1.8/1.2			

Input Watts	LAMP ANSI	Initial Lumens	Lamp Hours
62	S68	4000	24000

Factory Installed Options
 Add suffix to Catalog Number

Swivel Photocontrol (/PCS)
 Single fusing for 120 and 277 volt (/F)

Double fusing for 208 and 240 volt. (/FF)
 Button Photocontrol (/PC)

Note: Specifications may change without notice