



# FF150W/PC



JOB NAME: \_\_\_\_\_  
 DATE: \_\_\_\_\_  
 TYPE: \_\_\_\_\_

## DESCRIPTION

Compact, tough and good looking cast aluminum housing with hinged framed glass lens. Integra Hood glare shield and stainless steel clip. 35 to 150 watt HPS Metal Halide Pulse Start. 50 & 70 watt with 120v reactor ballast or 100W with 277V NPF ballast. Lamp supplied.

## SPECIFICATIONS

### Finish:

Chip and fade resistant polyester powder coating

### Housing:

Precision die cast aluminum, 1/2" NPS threaded arm with locking swivel fits all standard mounting boxes

### Lens Gasket:

High temperature tubular silicone set in die cast retaining groove remains in place during relamping

### Lens:

Thermal tempered shock resistant glass

### Reflector:

Anodized semi-specular aluminum

### Socket:

Glazed porcelain 4kv pulse rated with nickel plated screw shell and spring contacts

### Sockets:

Porcelain with all copper current carrying components

### UL Listing:

Suitable for wet locations. Suitable for mounting within 4' of the ground

### EPA:

0.43

### Patents:

Pat. D420,458

### Photocontrol:

Button Photocontrol installed and wired for 120V

### Color:

White

### Weight:

8.1

## DIMENSIONS

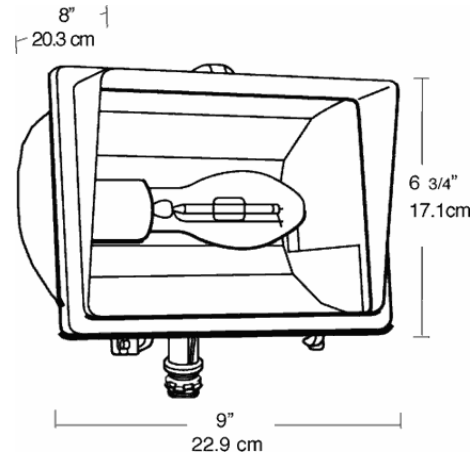

## PHOTOMETRIC

150w HPS @ 10' Mounting Height  
 Aimed 30° below horizontal

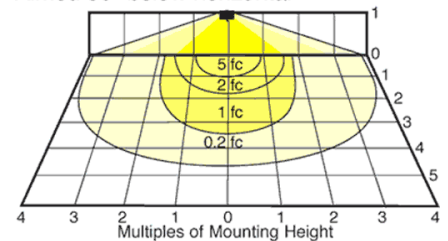

Mounting Height	Multiplier
8'	1.6
10'	1.0
12'	.7
16'	.4
20'	.25

Watts	Multiplier	HPS	MH	CFL
150	1			
100	.6	.6		
70	.4	.4		
50	.3	.2		
35	.15			
42			.2	

## ORDERING INFORMATION

**High Pressure Sodium**  
 Lamp supplied with fixture

Total Watts	Lamp Type	Lamp Base	Ballast
150	ED17	Medium	R-NPF 120V

Starting Amps/ Operating Amps			
120V	208V	240V	277V
4.5/3.2			

Input Watts	LAMP ANSI	Initial Lumens	Lamp Hours
170	S55	16000	24000

**Factory Installed Options**  
 Add suffix to Catalog Number

Swivel Photocontrol (/PCS)  
 Single fusing for 120 and 277 volt (/F)

Double fusing for 208 and 240 volt. (/FF)  
 Button Photocontrol (/PC)

Note: Specifications may change without notice