



# FZS400SFQT



JOB NAME: \_\_\_\_\_  
 DATE: \_\_\_\_\_  
 TYPE: \_\_\_\_\_

## DESCRIPTION

Floodzilla with integral slipfitter for O.D. 2 3/8" tenon size. slipfitter joint adjusts over 180° arc. Lamp supplied.

## SPECIFICATIONS

### Finish:

Chip and fade resistant polyester powder coating

### Housing:

Precision die cast aluminum

### Lens Gasket:

Molded one-piece silicone in die cast retaining groove to remain in place during relamping

### Lens:

Tempered shock resistant glass

### Reflector:

High quality anodized aluminum

### Socket:

Glazed porcelain 4kv pulse rated with nickel plated screw shell and spring contacts

### UL Listing:

Suitable for wet locations. Suitable for mounting within 4' of the ground.

### EPA:

1.3

### Patents:

Pat. D547,478

### Quad Tap:

Fixture works with 120, 208, 240 and 277 Volts

### Color:

Bronze

### Weight:

33.2

## DIMENSIONS

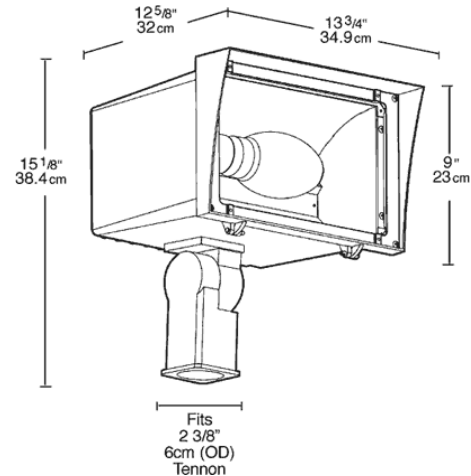

## PHOTOMETRIC

400w HPS fixture @30' mounting height aimed @45° below horizontal

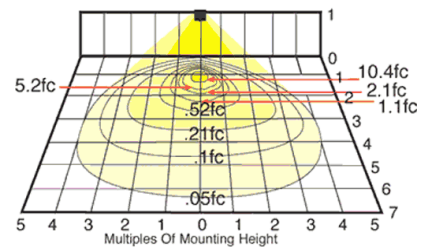

Mounting Height	Multiplier	Watts	Multiplier
40'	.6	175	.3
30'	1.0	200PS	.4
25'	1.4	250	.6 .4
20'	2.3	250PS	.5
15'	4.0	320PS	.6
		350PS	.7
		400	1.0 .7
		400PS	.8

## ORDERING INFORMATION

**High Pressure Sodium**  
Lamp supplied with fixture

Total Watts	Lamp Type	Lamp Base	Ballast	Starting Amps/ Operating Amps				Input Watts	LAMP ANSI	Initial Lumens	Lamp Hours
				120V	208V	240V	277V				
400	ED18	Mogul	CWA-HPF QT	3.3/3.8	1.8/2.2	1.5/1.9	1.4/1.7	464	S51	50000	24000

**Factory Installed Options**  
Add suffix to Catalog Number

Swivel Photocontrol wired for 120V (/PCS)      Button Photocontrol wired for 120V (/PC)  
 Button Photocontrol wired for 480 (/PC4)      480 volt only ballast (/480)  
 Button Photocontrol wired for 208 - 277V (/PC2)

Note: Specifications may change without notice