

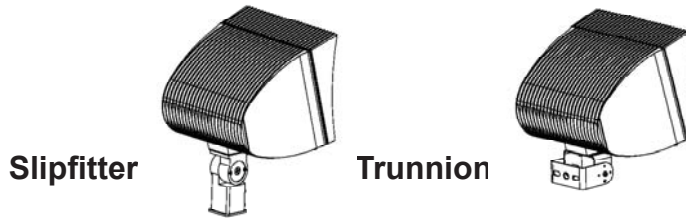

FXL SF & TRUNNION INSTALLATION INSTRUCTIONS



Thank you for buying RAB lighting fixtures. Our aim is to design the best quality products to get the job done right. We'd like to hear your comments. Call the Marketing Department at 888-RAB-1000, or email: marketing@rabweb.com

IMPORTANT

READ CAREFULLY BEFORE INSTALLING FIXTURE. RETAIN THESE INSTRUCTIONS FOR FUTURE REFERENCE. RAB fixtures must be wired in accordance with the National Electrical Code and all applicable local codes. Proper grounding is required for safety. This product must be installed in accordance with the applicable installation code by a person familiar with the construction and operations of the product and the hazards involved.

WARNING: Make certain power is OFF before installing or maintaining fixture.

LOCATION

1. Slipfitter mounted floodlight can be mounted on a 2 3/8" diameter pipe.
2. Trunnion mounted floodlight can be mounted to a flat surface.
3. Accessories are available for alternate installations.

WIRING

All units are factory wired for 277V. If voltages other than 277V are required, remove the reflector and rewire for the appropriate voltage.

1. Connect the appropriate BLACK fixture lead to the (+) LINE supply lead.
2. Connect the WHITE fixture lead to the (-) COMMON supply lead.
3. Fixture ground wire must be connected to supply ground.
4. All unused leads must be capped and insulated.

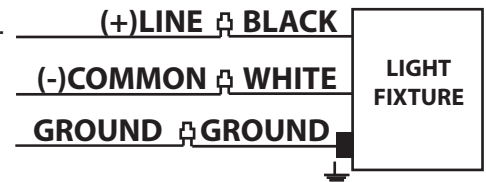

LAMP INSTALLATION

CAUTION: Prior to installing, check that the lamp is the correct ANSI type and wattage. Observe lamp manufacturer's recommendations on lamp operation, ballast type and burning positions.

1. Disconnect power. Make sure fixture and lamp are cool enough to touch.
2. Open fixture by removing the (4) door screws. Swing lens door down on hinges.
3. Insert lamp.
4. Before closing lens door make sure frame gasket is properly seated all around fixture.
5. Close door. Tighten (4) screws.

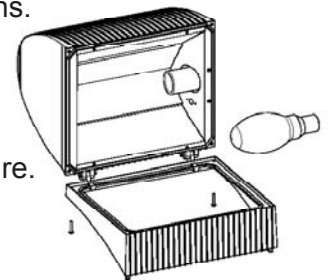

REPLACEMENT LAMPS

| High Pressure Sodium Wattage | Catalog# | ANSI Code | Metal Halide Wattage | Catalog# | ANSI Code |
|------------------------------|----------|-----------|----------------------|----------|-----------|
| 250 | LHPS250 | S50 | 250 | LMH250 | M58 |
| 400 | LHPS400 | S51 | 250PS | LMH250PS | M153 |
| | | | 320PS | LMH320PS | M154 |
| | | | 350PS | LMH350PS | M131 |
| | | | 400 | LMH400 | M59 |
| | | | 400PS | LMH400PS | M155 |

CLEANING

Clean glass lens with nonabrasive glass cleaning solution.

CAUTION: Be sure fixture temperature is cool enough to touch. Do not clean or maintain while fixture is energized.

FXL SF & TRUNNION INSTALLATION INSTRUCTIONS

BEAM SPREAD ADJUSTMENT

WARNING: Make certain power is off.

The lamp socket can be moved from the standard beam position to the rear position to provide a more narrow beam or the front for a wider beam.

1. Remove (4) **Reflector Screws**.
2. Remove the **Reflector** from the fixture.
3. Loosen two socket nuts and slide socket into desired position.
4. Tighten nuts. Replace **Reflector** in fixture and secure with (4) **Reflector Screws**.

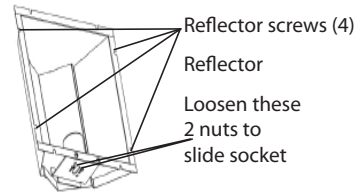

SLIPFITTER MOUNTING

1. The slipfitter fits a **2 3/8" O.D. tenon**. Place the slipfitter over the tenon and secure with the (2) **Set Screws** on the side of the slipfitter.
2. The angle of the fixture can be adjusted.
 - a. Remove (2) **Cover Plate Screws** and the **Round Cover Plate**.
 - b. Loosen the **Locking Bolt** and swivel the fixture.
 - c. Tighten the **Locking Bolt** and re-attach **Round Cover Plate**.

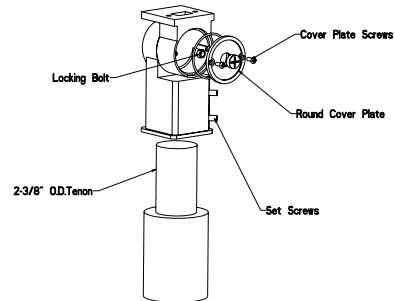

TRUNNION MOUNTING

1. Adjust the angle of the fixture at the trunnion.
 - a. Loosen (2) **Pivot Bolts** and **Angle Locking Screw**.
 - b. Swivel the fixture.
 - c. Tighten the **Pivot Bolts** and **Angle Locking Screw**.

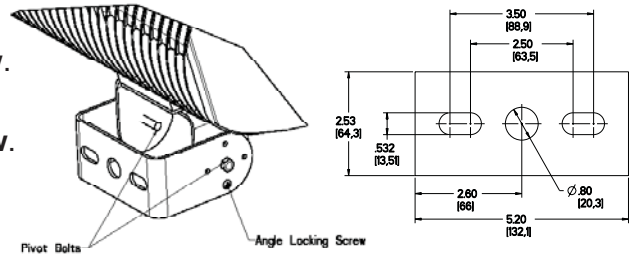

TROUBLESHOOTING

Check That:

1. Proper lamp is installed. Lamp is not faulty.
2. Fixture is wired properly.
3. Line voltage at the fixture is correct.
4. Fixture is grounded properly.

ACCESSORIES

Wire Guard mounts with (4) stainless steel screws to door as shown. Order separately, CAT# GDFXL.

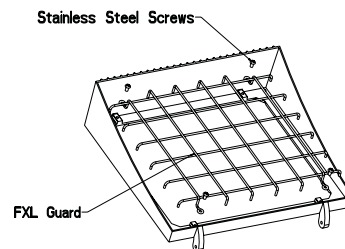

Note: These instructions do not cover all details or variations in equipment nor do they provide for every possible situation during installation, operation or maintenance.

EASY INSTALLATION & PRODUCT HELP

rabweb.com
Visit our website
for product info

Tech Help Line
Call our experts
888 RAB-1000

Toll Free Fax
Send a fax to RAB
888 RAB-1232

E-mail
Answered promptly
sales@rabweb.com



©RAB Lighting, Inc.
170 Ludlow Avenue Northvale, NJ 07647 USA