

Project: _____

Fixture Type: _____

Location: _____

Contact/Phone: _____

4" IC 700 LUMEN INTERNALLY ADJUSTABLE LED DOWNLIGHT NEW CONSTRUCTION

IC4AL (07LM) RECESSED HOUSING



SLOPE CEILING TRIMS



PRODUCT DESCRIPTION

Patent pending dedicated LED, Air-Loc® sealed new construction housing with integral internally adjustable light engine • Double wall, shallow housing construction • Can be completely covered with insulation and installs in 2 x 6 construction • Fully sealed housing stops infiltration and exfiltration of air, reducing heating and cooling costs without the use of additional gaskets • LED housing is designed to provide 50,000 hours of life • 5 year limited warranty on LED components.

ENVIRONMENTALLY FRIENDLY, ENERGY EFFICIENT

- No harmful ultraviolet or infrared wavelengths
- No lead or mercury, RoHS compliant
- Comparable light output to 65W incandescent

PRODUCT SPECIFICATIONS

LED Light Engine LED array attached to cast aluminum sliding heatsink integrated directly with housing provides superior heat transfer to ensure long life of the LED • Replaceable light engine mounts directly to inner housing assembly and incorporates the latest generation, high lumen output LED array • LEDs are binned within a 3-step MacAdam Ellipse exceeding ENERGY STAR® requirements for superior fixture to fixture color uniformity • 2700K, 3000K, 3500K, or 4000K color temperatures available • 90 CRI minimum.

Optics Three field interchangeable, TIR optics available in 18°, 30° and 40° beam angles • Module can accommodate one 2-inch diameter beam control lens or filter • Adjustable light engine module provides up to 35° vertical adjustment and 360° rotation.

Aesthetic Trim Selections Exclusive trim design to cover slope ranges from 9-24° (46L) and 20-35° (48L) • Aluminum angle-cut reflector in clear, black, pewter, white, haze and wheat haze • Shadow free, knife edge design blends seamlessly into ceiling.

LED Driver Choice of dedicated 120 volt (120) driver or universal voltage (MVOLT) driver that accommodates input voltages from 120-277 volts AC at 50/60Hz • Power factor > 0.9 at 120V input • 120 volt only driver is dimmable with the use of most incandescent, magnetic low voltage and electronic low voltage wall box dimmers • Universal voltage driver is dimmable with the use of most 0-10V wall box dimmers • For a list of compatible dimmers, see [JUNOICLED-DIM](#).

Life Rated for 50,000 hours at 70% lumen maintenance.

Labels ENERGY STAR® Certified • Certified to the high efficacy requirements of California T24 JA8-2016 • UL listed for U.S. and Canada for through-branch wiring, damp locations • Union made • UL and cUL.

Testing All reports are based on published industry procedures; field performance may differ from laboratory performance.

Specifications subject to change without notice.

HOUSING FEATURES

Housing Designed for use in IC (insulated ceiling) or non-IC construction • Aluminum housing sealed for Air-Loc® compliance • Housing is vertically adjustable to accommodate up to a 1 1/2" ceiling thickness.

Junction Box Pre-wired junction box provided with (6) 1/2" and (1) 3/4" knockouts, (4) knockouts for 12/2 or 14/2 NM cable and ground wire • UL listed and cUL listed for through-branch wiring, maximum 4 #12 branch circuit conductors • Junction box provided with removable access plates • Knockouts equipped with pryout slots • Quick connect electrical connectors supplied as standard for fast, secure installation.

Mounting Frame 22-gauge die-formed galvanized steel mounting frame • Rough-in section (junction box, mounting frame, housing and bar hangers) fully assembled for ease of installation.

Real Nail 3 Bar Hangers Patented (US Patent D552,969) Real Nail® 3 bar hangers: telescoping system permits quick placement of housing anywhere within 24" O.C. joists or suspended ceilings • Includes removable nail for repositioning of fixture in wood joist construction • Integral T-bar notch and clip for suspended ceilings.

DIMENSIONS

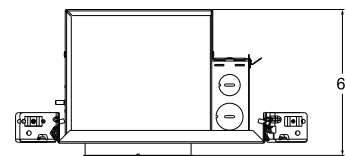
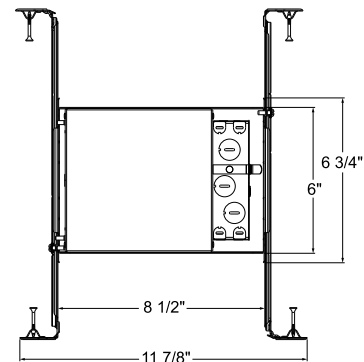

4 1/2" CEILING CUTOUT

ELECTRICAL DATA

Dedicated 120V Only Driver Option (120) 120V

Input Power	10.5W (+/-5%)	
Input Current	0.10A	
Frequency	50/60Hz	
EMI/RFI	FCC Title 47 CFR, Part 15, Class B (Residential)	
Minimum starting temp	-25°C (-13°F)	

Universal Voltage Driver (MVOLT ZT)

	120V	277V
Input Power	10.0W (+/-5%)	10.0W (+/-5%)
Input Current	0.09A	0.04A
Frequency	50/60Hz	50/60Hz
EMI/RFI	FCC Title 47 CFR, Part 15, Class A (Commercial)	FCC Title 47 CFR, Part 15, Class A (Commercial)
Minimum starting temp	-20°C (-4°F)	-20°C (-4°F)

Lutron Hi-Lume® LED Driver (MVOLT ECOS3)

	120V	277V
Input Power	11.1W (+/-5%)	11.3W (+/-5%)
Input Current	0.10A	0.05A
Frequency	50/60Hz	50/60Hz
EMI/RFI	FCC Title 47 CFR, Part 15, Class A (Commercial)	FCC Title 47 CFR, Part 15, Class A (Commercial)
Minimum starting temp	0°C (32°F)	0°C (32°F)

4" IC 700 LUMEN INTERNALLY ADJUSTABLE LED DOWNLIGHT NEW CONSTRUCTION

IC4AL (07LM) RECESSED HOUSING SLOPE CEILING TRIMS

ORDERING INFORMATION Housing and trim can be ordered together or separate, but will always ship separately.

Example: IC4AL 07LM 27K 90CRI FL 120 FRPC

Series	Lumens	Color Temperature	CRI	Distribution	Voltage	Driver
IC4AL 4" LED Internally Adjustable New Const. IC Downlight	07LM 700 Nominal Lumens	27K 2700K 30K 3000K 35K 3500K 40K 4000K	90CRI 90+ CRI	FL Flood NFL Narrow Flood SP Spot	120 120V MVOLT Multi-Volt (120-277V)	ECOS3 Lumen Hi - Lume A Series, 3-wire fluorescent controls & Lutron Ecosystem FRPC Forward/ Reverse Phase Cut ZT 0 - 10V Dimming Driver

Notes: 120 must be ordered with FRPC. MVOLT can be ordered with either ZT or ECOS3

Trim/Description



Standard Slope 9° to 24°

- 46L BWH** 4" Angle Cut Cone - Standard Slope 9° to 24° - Black Alzak® Cone, White Trim Ring
46L CWH 4" Angle Cut Cone - Standard Slope 9° to 24° - Clear Alzak® Cone, White Trim Ring
46L HZWH 4" Angle Cut Cone - Standard Slope 9° to 24° - Haze Cone, White Trim Ring
46L PTSC 4" Angle Cut Cone - Standard Slope 9° to 24° - Pewter Alzak® Cone, Satin Chrome Trim Ring
46L WHZABZ 4" Angle Cut Cone - Standard Slope 9° to 24° - Wheat Haze Cone, Classic Aged Bronze Trim Ring
46L WHZWH 4" Angle Cut Cone - Standard Slope 9° to 24° - Wheat Haze Cone, White Trim Ring
46L WWH 4" Angle Cut Cone - Standard Slope 9° to 24° - Gloss White Cone, White Trim Ring



Super Slope 20° to 35°

- 48L BWH** 4" Angle Cut Cone - Super Slope 20° to 35° - Black Alzak® Cone, White Trim Ring
48L CWH 4" Angle Cut Cone - Super Slope 20° to 35° - Clear Alzak® Cone, White Trim Ring
48L HZWH 4" Angle Cut Cone - Super Slope 20° to 35° - Haze Cone, White Trim Ring
48L PTSC 4" Angle Cut Cone - Super Slope 20° to 35° - Pewter Alzak® Cone, Satin Chrome Trim Ring
48L WHZABZ 4" Angle Cut Cone - Super Slope 20° to 35° - Wheat Haze Cone, Classic Aged Bronze Trim Ring
48L WHZWH 4" Angle Cut Cone - Super Slope 20° to 35° - Wheat Haze Cone, White Trim Ring
48L WWH 4" Angle Cut Cone - Super Slope 20° to 35° - Gloss White Cone, White Trim Ring

Trim Size: 5" O.D.

Alzak is a registered trademark of Alcoa Corp.

Note: In Canada when insulation is present, Type IC fixtures must be used.

Accessories (ordered separately)

Catalog Number	Description
CGF 200 MPINK	Color Glass Filter - 2" Diameter - Medium Pink
CGF 200 WRED	Color Glass Filter - 2" Diameter - Warm Red
CGF 200 DLTBLUE	Color Glass Filter - 2" Diameter - Daylight Blue
CGF 200 MBLU	Color Glass Filter - 2" Diameter - Medium Blue
CGF 200 MAMB	Color Glass Filter - 2" Diameter - Medium Amber
CGF 200 MGRN	Color Glass Filter - 2" Diameter - Medium Green
DGF 200 DRED	Dichroic Glass Filter - 2" Diameter Red
DGF 200 MGRN	Dichroic Glass Filter - 2" Diameter Medium Green
DGF 200 MBLU	Dichroic Glass Filter - 2" Diameter Medium Blue
DGF 200 DYEL	Dichroic Glass Filter - 2" Diameter Yellow (Dichroic)
DGF 200 MAGEN	Dichroic Glass Filter - 2" Diameter Magenta
DGF 200 CYAN	Dichroic Glass Filter - 2" Diameter Cyan
DCCF 200 HL4250	Dichroic Color Correction Filter - 2" Diameter - Halogen - to - Daylight
DIFF 200	Diffusion Glass Lens - 2" Diameter
UVF 200	UV Filter Lens - 2" Diameter
HCLBL 200	Hexagonal Cell Louver - Black - 2" Diameter
ISPREAD 200	Linear Spread Glass Lens - 2" Diameter
PRISM 200	Prismatic Glass Lens - 2" Diameter
TIR2 SPT	TIR Optic - Spot
TIR2 NFLD	TIR Optic - Narrow Flood
TIR2 FLD	TIR Optic - Flood

4" IC 700 LUMEN INTERNALLY ADJUSTABLE LED DOWNLIGHT NEW CONSTRUCTION

IC4AL (07LM) RECESSED HOUSING

SLOPE CEILING TRIMS

PHOTOMETRICS

PHOTOMETRIC REPORT

Test Report#: PTO2162301R
Catalog No: IC4AL 07LM 35K 90CRI SP 120
FRPC with 46L HZWH, Standard Slope Haze
Finish Trim and Spot Optic
Luminaire Spacing Criteria: 1.40
Luminaire LPW: 70

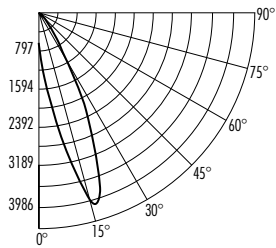

CANDLEPOWER DISTRIBUTION (Candelas)

Degrees Vertical	0°
0	688
5	1245
10	2521
15	3986
20	3825
25	2312
30	1112
35	606
40	339
45	197
50	116
55	35
60	16
65	5
70	1
75	0
80	0
85	0
90	0

AVERAGE INITIAL FOOTCANDLES

Multiple Units (Square Array, 60'x60' room)
Ceiling 80%, Wall 50%, Floor 20%

Spacing	RCR1	RCR3	RCR5
4.0'	51	45	39
5.0'	33	29	25
6.0'	23	20	17
7.0'	18	16	14
8.0'	15	13	11
9.0'	11	10	9
10.0'	8	7	6

ZONAL LUMEN SUMMARY

Zone	Lumens	%Lamp	%Fixture
0-30°	566	N/A	76.7
0-40°	678	N/A	91.9
0-60°	736	N/A	99.8
0-90°	738	N/A	100.0

For 2700K fixtures, use 0.93 multiplier; for 3000K fixtures, use 0.96 multiplier;
for 3500K fixtures, use 1.00 multiplier; for 4000K fixtures, use 1.03 multiplier.

INITIAL FOOTCANDLES

(One Unit, 10.5W, 17.6° Beam)

Distance to Illuminated Plane (Feet)	Footcandles Beam Center	Beam Diameter
4	260.4	1.2
6	115.7	1.9
8	65.1	2.5
10	41.7	3.1

LUMINANCE (Average cd/m²)

Degrees	Average 0° Luminance
45	52404
55	11475
65	2284
75	52
85	0

PHOTOMETRIC REPORT

Test Report#: PTO1162002R
Catalog No: IC4AL 07LM 35K 90CRI NFL 120
FRPC with 46L HZWH, Standard Slope Haze
Finish Trim and Narrow Flood Optic
Luminaire Spacing Criteria: 1.50
Luminaire LPW: 73

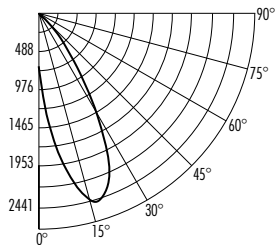

CANDLEPOWER DISTRIBUTION (Candelas)

Degrees Vertical	0°
0	739
5	1434
10	2098
15	2418
20	2441
25	2166
30	1583
35	888
40	421
45	237
50	153
55	47
60	26
65	7
70	2
75	0
80	0
85	0
90	0

AVERAGE INITIAL FOOTCANDLES

Multiple Units (Square Array, 60'x60' room)
Ceiling 80%, Wall 50%, Floor 20%

Spacing	RCR1	RCR3	RCR5
4.0'	53	46	40
5.0'	34	29	26
6.0'	24	20	18
7.0'	19	17	14
8.0'	15	13	11
9.0'	12	10	9
10.0'	8	7	6

ZONAL LUMEN SUMMARY

Zone	Lumens	%Lamp	%Fixture
0-30°	557	N/A	73.0
0-40°	693	N/A	90.8
0-60°	762	N/A	99.7
0-90°	764	N/A	100.0

For 2700K fixtures, use 0.93 multiplier; for 3000K fixtures, use 0.96 multiplier;
for 3500K fixtures, use 1.00 multiplier; for 4000K fixtures, use 1.03 multiplier.

INITIAL FOOTCANDLES

(One Unit, 10.5W, 28.9° Beam)

Distance to Illuminated Plane (Feet)	Footcandles Beam Center	Beam Diameter
4	154.1	2.1
6	68.5	3.1
8	38.5	4.1
10	24.7	5.2

LUMINANCE (Average cd/m²)

Degrees	Average 0° Luminance
45	62827
55	15268
65	3153
75	52
85	0

PHOTOMETRIC REPORT

Test Report#: PTO2162302R
Catalog No: IC4AL 07LM 35K 90CRI FL 120
FRPC with 46L HZWH, Standard Slope Haze
Finish Trim and Flood Optic
Luminaire Spacing Criteria: 1.42
Luminaire LPW: 74

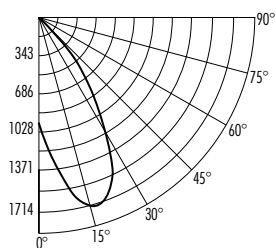

CANDLEPOWER DISTRIBUTION (Candelas)

Degrees Vertical	0°
0	945
5	1286
10	1558
15	1714
20	1700
25	1541
30	1256
35	868
40	530
45	275
50	123
55	50
60	19
65	7
70	0
75	0
80	0
85	0
90	0

AVERAGE INITIAL FOOTCANDLES

Multiple Units (Square Array, 60'x60' room)
Ceiling 80%, Wall 50%, Floor 20%

Spacing	RCR1	RCR3	RCR5
4.0'	54	47	41
5.0'	34	30	26
6.0'	24	21	18
7.0'	19	17	15
8.0'	15	13	12
9.0'	12	10	9
10.0'	9	7	7

ZONAL LUMEN SUMMARY

Zone	Lumens	%Lamp	%Fixture
0-30°	551	N/A	71.0
0-40°	704	N/A	90.8
0-60°	774	N/A	99.8
0-90°	775	N/A	100.0

For 2700K fixtures, use 0.93 multiplier; for 3000K fixtures, use 0.96 multiplier;
for 3500K fixtures, use 1.00 multiplier; for 4000K fixtures, use 1.03 multiplier.

INITIAL FOOTCANDLES

(One Unit, 10.5W, 36.5° Beam)

Distance to Illuminated Plane (Feet)	Footcandles Beam Center	Beam Diameter
4	107.7	2.6
6	47.9	4.0
8	26.9	5.3
10	17.2	6.6

LUMINANCE (Average cd/m²)

Degrees	Average 0° Luminance
45	73000
55	16287
65	3121
75	52
85	0

4" IC 700 LUMEN INTERNALLY ADJUSTABLE LED DOWNLIGHT NEW CONSTRUCTION

IC4AL (07LM) RECESSED HOUSING SLOPE CEILING TRIMS

PHOTOMETRICS

PHOTOMETRIC REPORT

Test Report#: PTO2162303R
Catalog No: IC4AL 07LM 35K 90CRI FL 120
FRPC with 48L HZWH, Super Slope Haze Finish
Trim and Spot Optic
Luminaire Spacing Criteria: 2.28
Luminaire LPW: 70

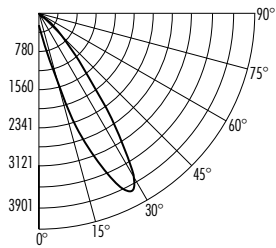

CANDLEPOWER DISTRIBUTION (Candelas)

Degrees Vertical	0°
0	241
5	382
10	647
15	1195
20	2451
25	3901
30	3772
35	2300
40	1126
45	632
50	356
55	193
60	67
65	32
70	8
75	3
80	0
85	0
90	0

AVERAGE INITIAL FOOTCANDLES Multiple Units (Square Array, 60'x60' room)

Ceiling 80%, Wall 50%, Floor 20%

Spacing	RCR1	RCR3	RCR5
4.0'	50	42	35
5.0'	32	27	23
6.0'	22	19	16
7.0'	18	15	13
8.0'	14	12	10
9.0'	11	9	8
10.0'	8	7	6

ZONAL LUMEN SUMMARY

Zone	Lumens	%Lamp	%Fixture
0-30°	379	N/A	51.7
0-40°	591	N/A	80.6
0-60°	725	N/A	98.9
0-90°	733	N/A	100.0

For 2700K fixtures, use 0.93 multiplier; for 3000K fixtures, use 0.96 multiplier; for 3500K fixtures, use 1.00 multiplier; for 4000K fixtures, use 1.03 multiplier.

INITIAL FOOTCANDLES (One Unit, 10.5W, 18.0° Beam)

Distance to Illuminated Plane (Feet)	Footcandles Beam Center	Beam Diameter
4	256.4	1.3
6	113.9	1.9
8	64.1	2.5
10	41.0	3.2

LUMINANCE (Average cd/m²)

Degrees	Average 0° Luminance
45	168001
55	63175
65	14008
75	2032
85	155

PHOTOMETRIC REPORT

Test Report#: PTO1162001R
Catalog No: IC4AL 07LM 35K 90CRI FL 120
FRPC with 48L HZWH, Super Slope Haze Finish
Trim and Narrow Flood Optic
Luminaire Spacing Criteria: 2.32
Luminaire LPW: 73

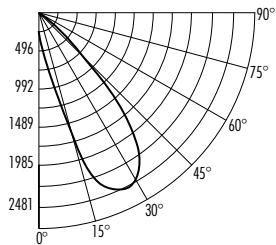

CANDLEPOWER DISTRIBUTION (Candelas)

Degrees Vertical	0°
0	247
5	406
10	849
15	1582
20	2208
25	2481
30	2444
35	2119
40	1486
45	796
50	385
55	221
60	71
65	36
70	10
75	3
80	0
85	0
90	0

AVERAGE INITIAL FOOTCANDLES Multiple Units (Square Array, 60'x60' room)

Ceiling 80%, Wall 50%, Floor 20%

Spacing	RCR1	RCR3	RCR5
4.0'	52	44	37
5.0'	38	28	24
6.0'	23	19	16
7.0'	19	16	13
8.0'	15	12	11
9.0'	11	10	8
10.0'	8	7	6

ZONAL LUMEN SUMMARY

Zone	Lumens	%Lamp	%Fixture
0-30°	382	N/A	49.7
0-40°	608	N/A	79.2
0-60°	760	N/A	98.9
0-90°	769	N/A	100.0

For 2700K fixtures, use 0.93 multiplier; for 3000K fixtures, use 0.96 multiplier; for 3500K fixtures, use 1.00 multiplier; for 4000K fixtures, use 1.03 multiplier.

INITIAL FOOTCANDLES (One Unit, 10.5W, 28.9° Beam)

Distance to Illuminated Plane (Feet)	Footcandles Beam Center	Beam Diameter
4	156.3	2.1
6	69.4	3.1
8	39.1	4.1
10	25.0	5.2

LUMINANCE (Average cd/m²)

Degrees	Average 0° Luminance
45	211541
55	72415
65	15891
75	1980
85	155

PHOTOMETRIC REPORT

Test Report#: PTO2162304R
Catalog No: IC4AL 07LM 35K 90CRI FL 120
FRPC with 48L HZWH, Super Slope Haze Finish
Trim and Flood Optic
Luminaire Spacing Criteria: 2.22
Luminaire LPW: 73

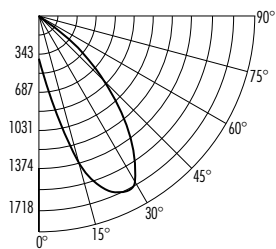

CANDLEPOWER DISTRIBUTION (Candelas)

Degrees Vertical	0°
0	388
5	653
10	984
15	1336
20	1592
25	1718
30	1692
35	1508
40	1205
45	839
50	533
55	306
60	125
65	49
70	17
75	3
80	0
85	0
90	0

AVERAGE INITIAL FOOTCANDLES Multiple Units (Square Array, 60'x60' room)

Ceiling 80%, Wall 50%, Floor 20%

Spacing	RCR1	RCR3	RCR5
4.0'	52	44	37
5.0'	34	28	23
6.0'	23	19	16
7.0'	19	16	13
8.0'	15	12	10
9.0'	11	10	8
10.0'	8	7	6

ZONAL LUMEN SUMMARY

Zone	Lumens	%Lamp	%Fixture
0-30°	374	N/A	48.7
0-40°	581	N/A	75.6
0-60°	758	N/A	98.6
0-90°	769	N/A	100.0

For 2700K fixtures, use 0.93 multiplier; for 3000K fixtures, use 0.96 multiplier; for 3500K fixtures, use 1.00 multiplier; for 4000K fixtures, use 1.03 multiplier.

INITIAL FOOTCANDLES (One Unit, 10.5W, 36.6° Beam)

Distance to Illuminated Plane (Feet)	Footcandles Beam Center	Beam Diameter
4	107.6	2.6
6	47.8	4.0
8	26.9	5.3
10	17.2	6.6

LUMINANCE (Average cd/m²)

Degrees	Average 0° Luminance
45	222965
55	100253
65	21699
75	2292
85	0