

PRODUCT SPECIFICATIONS

LED Light Engine Consistent fixture to fixture color consistency within a 2-step MacAdam ellipse • 2700K, 3000K, 3500K, or 4000K color temperatures are available with 80 CRI minimum • 2700K and 3000K are also available with 90 CRI minimum.

Modular Optics 50° cutoff to source and source image • Available with field interchangeable optics in 18° Spot, 24° Narrow Flood, 35° Flood, and 45° wide flood distributions • Additional distributions of 20°, 30°, 50° and 55° FWHM can be achieved with the use of the diffusing films and spot primary optic.

Trims Style Self Flanged and Flangeless styles (drywall only) are available

LED Driver Choice of two drivers to accommodate voltages from 120-277 volts AC at 50/60Hz • Compatible with most incandescent and electronic low voltage dimmers or 0-10V dimmers • For a list of compatible dimmers, refer to [ACLXLED2-DIM](#) • Power Factor > 0.9 • Field replaceable from above or below ceiling.

Life Rated for 50,000 hrs at 70% lumen maintenance.

Codes/Labels UL and cUL listed for damp locations. Wet location listed with WET option • ENERGY STAR® Certified with select color temperatures and trims • Union made.

Remodel Installation Fixture installs from below the ceiling and secured to remodel ring.

Wiring Includes (2) 1/2" knockouts equipped with pryout slots and are compatible with flexible electrical supply only • Supplied with quick connect electrical connectors.

Ceiling Thickness 1/2" – 1 1/2" ceiling standard.

Warranty 5-year limited warranty. Complete warranty terms located at www.acuitybrands.com/CustomerResources/Terms_and_conditions.aspx



**2" LED RECESSED
 DOWNLIGHT
 800/1200 LUMEN
 SQUARE APERTURE
 REMODEL
 AX2SQ DR**



AX2SQ DR

NOTE: Actual performance may differ as a result of end-user environment and application.

All values are design or typical values, measured under laboratory conditions at 25°C.

Specifications subject to change without notice.

ORDERING INFORMATION

Example: AX2SQ DR 08LM 30K 80CRI 24D FPC 120

HOUSING OPTIONS	Series / Housing Style	Lumens	CCT	CRI	Beam	Driver	Voltage ¹	Options
	AX2SQ DR Remodel Downlight	08LM 800 Lumens 12LM 1200 Lumens	27K 2700K 30K 3000K 35K 3500K 40K 4000K	80CRI 90CRI ⁶	18D 18° beam 24D 24° beam 35D 35° beam 45D 45° beam	FPC Phase cut dimming, 5% dim ZT 0-10V Dimming, 10% dim	120 MVOLT (120-277)	NLIGHT ² nLight dimming pack controls

TRIM OPTIONS	Square Trim Style	Reflector Finish	Flange Style / Finish	Environment	Ceiling Installation
	DOWNLIGHT	BD Black Diffuse CD ⁴ Clear Diffuse W ⁴ White Paint WTD ⁴ Wheat Diffuse	2SQD Square Reflector 2SQDBV Square Bevel 2SQDPIN Square Pinhole, 1 1/4"	SELF-FLANGED SF ⁴ Flange is same finish as reflector WHSF White, flanged BLSF ³ Black, flanged FLANGELESS ⁵ FM ⁴ Flangeless WHFM ³ Flangeless, White trim BLFM ³ Flangeless, Black trim	WET Wet location

NOTES	Ordering Notes
	¹ MVOLT standard on ZT. 120 standard on FPC.
	² NLIGHT compatible with ZT only.
	³ Available only on 2SQDBV and 2SQDPIN.
	⁴ Available only on 2SQD.
	⁵ Flangeless trims in drywall ceiling must be specified with Flangeless ceiling installation (FMA2SQR).
	⁶ Available on 27K and 30K only.

2" LED RECESSED DOWNLIGHT 800/1200 LUMEN SQUARE APERTURE REMODEL AX2SQ DR

DIMENSIONS

REMODEL

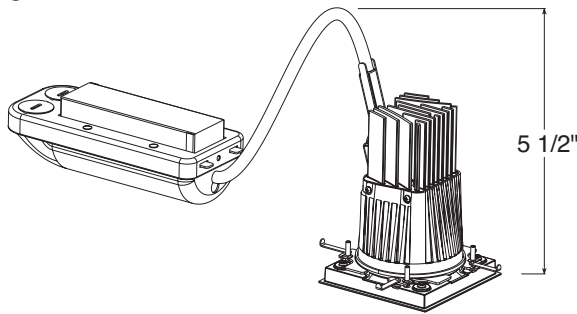

AX2SQ DR

Trim Style	Cutout Size
Self Flanged Trims	3.044" x 3.044"
Flangeless Trims (Drywall Ceiling)	3.044" x 3.044"

ELECTRICAL DATA

Lumen Package	08LM			12LM		
	FPC	ZT		FPC	ZT	
Voltage	120	120	277	120	120	277
Input Power	10.1	9.6	9.6	14.8	14.8	14.6
Input Current	0.09	0.08	0.04	0.12	0.12	0.06
Frequency	50/60Hz	50/60Hz		50/60Hz	50/60Hz	
Power Factor	0.99	0.99	0.93	0.99	0.99	0.95

ACCESSORIES

Cat. #	Description
2AXOPT/18D	18° Spot Optic
2AXOPT/24D	24° Narrow Flood Optic
2AXOPT/35D	35° Flood Optic
2AXOPT/45D	45° Wide Flood Optic
AF2/10	10° Film (Use with Spot Optic)
AF2/20	20° Film (Use with Spot Optic)
AF2/40	40° Film (Use with Spot Optic)
AF2/50	50° Film (Use with Spot Optic)
AF2/90x1	90°x1° Film (Use with Spot Optic)
EMI20	20W Emergency Lighting Inverter

To order, specify catalog number.

DIFFUSING FILMS

To achieve the desired beam angle (FWHM), specify the following primary LED optic on the luminaire and order the diffusing film from the table below

Desired FWHM	Primary Optic	Film
18°	18D	-
20°	18D	AF2/10
24°	24D	-
30°	18D	AF2/20
35°	35D	-
45°	45D	-
50°	18D	AF2/40
55°	18D	AF2/50
60°x20°	18D	AF2/90x1

2" LED RECESSED DOWNLIGHT 800/1200 LUMEN SQUARE APERTURE REMODEL AX2SQ DR

TRIM SELECTION

DOWNLIGHT TRIMS

2SQD Square Downlight Reflector

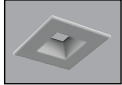

Self-Flanged

Aperture: 1 3/4"



Flangeless



CCT/CRI:	80CRI 27K, 30K, 35K, 40K
Optic:	18D, 24D, 35D, 45D
Trim Finish:	CD, WTD, BD, W

2SQDBV Square Downlight Bevel

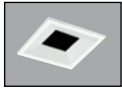

Self-Flanged

Aperture: 1 3/8"

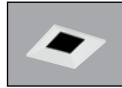

Flangeless



CCT/CRI:	80CRI 27K, 30K, 35K, 40K
Optic:	18D, 24D, 35D
Trim Finish:	BD

2SQDPIN Square Downlight Pinhole



Self-Flanged

Aperture: 1 1/4"



Flangeless



CCT/CRI:	80CRI 27K, 30K, 35K, 40K
Optic:	18D, 24D, 35D
Trim Finish:	BD

* With WET option

2SQD Square Downlight Reflector

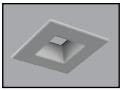

Self-Flanged

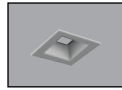

Flangeless



2" LED RECESSED DOWNLIGHT

800/1200 LUMEN

SQUARE DOWNLIGHT REFLECTOR REMODEL

2SQD

PHOTOMETRICS

SPOT PHOTOMETRIC REPORT

Test Report #: PT02141003
 Catalog No: AX2SQ DR 12LM 30K
 80CRI 18D FPC 120
 2SQD CD

Luminaire Spacing Criterion: 0.34

Luminaire LPW: 72

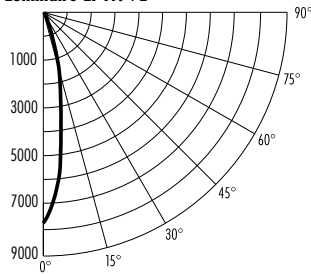

CANDLEPOWER DISTRIBUTION (Candelas)

Degrees Vertical	0°
0	7294
5	6251
15	1501
25	167
35	10
45	1
55	1
65	0
75	0
85	0
90	0

AVERAGE INITIAL FOOTCANDLES

Multiple Units (Square Array, 60'x60' room)
 Ceiling 80% Wall 50% Floor 20%

Spacing	RCR1	RCR3	RCR5
4.0'	76	70	66
5.0'	49	45	42
6.0'	34	31	29
7.0'	27	25	24
8.0'	22	20	19
9.0'	17	15	14
10.0'	12	11	11

INITIAL FOOTCANDLES

(One Unit, 14.8W, 19.6° Beam)

Distance to Illuminated Plane (Feet)	Footcandles Beam Center	Beam Diameter
6	202.6	2.1'
8	114.0	2.8'
10	72.9	3.5'
12	50.7	4.1'

ZONAL LUMEN SUMMARY

Zone	Lumens	%Fixture
0-30°	1056	98.7
0-40°	1069	99.8
0-60°	1070	100.0
0-90°	1070	100.0

LUMINANCE (Average cd/m²)

Degrees	Average Luminance
45	838
55	827
65	140
75	687
85	0

NARROW FLOOD PHOTOMETRIC REPORT

Test Report #: PT02141007
 Catalog No: AX2SQ DR 12LM 30K
 80CRI 24D FPC 120
 2SQD CD

Luminaire Spacing Criterion: 0.38

Luminaire LPW: 65

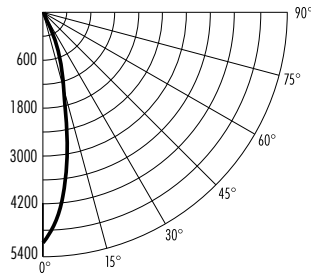

CANDLEPOWER DISTRIBUTION (Candelas)

Degrees Vertical	0°
0	5339
5	4560
15	1542
25	228
35	18
45	2
55	1
65	0
75	0
85	0
90	0

AVERAGE INITIAL FOOTCANDLES

Multiple Units (Square Array, 60'x60' room)
 Ceiling 80% Wall 50% Floor 20%

Spacing	RCR1	RCR3	RCR5
4.0'	66	63	59
5.0'	44	40	37
6.0'	30	28	26
7.0'	25	23	21
8.0'	19	18	17
9.0'	15	14	13
10.0'	11	10	9

INITIAL FOOTCANDLES

(One Unit, 14.8W, 21.9° Beam)

Distance to Illuminated Plane (Feet)	Footcandles Beam Center	Beam Diameter
6	143.3	2.3'
8	83.4	3.1'
10	53.4	3.9'
12	37.1	4.6'

ZONAL LUMEN SUMMARY

Zone	Lumens	%Fixture
0-30°	944	97.8
0-40°	962	99.6
0-60°	965	99.9
0-90°	966	100.0

LUMINANCE (Average cd/m²)

Degrees	Average Luminance
45	1257
55	827
65	561
75	229
85	680

Fixtures tested to IES recommended standard for solid state lighting per LM-79-08. Photometric performance on a single unit represents a baseline of performance for the fixture. Results may vary in the field. Photometry is at 3000K CCT.

2SQD Square Downlight Reflector

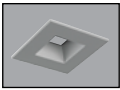

Self-Flanged

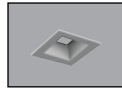

Flangeless



2" LED RECESSED DOWNLIGHT

800/1200 LUMEN

SQUARE DOWNLIGHT REFLECTOR REMODEL

2SQD (continued)

PHOTOMETRICS

FLOOD

PHOTOMETRIC REPORT

Test Report #: PT02141011

Catalog No: AX2SQ DR 12LM 30K

80CRI 35D FPC 120

2SQD CD

Luminaire Spacing Criterion: 0.66

Luminaire LPW: 65

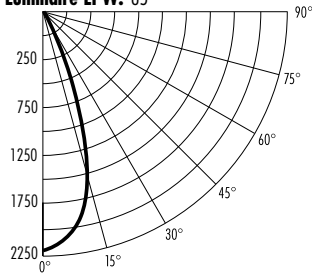

CANDLEPOWER DISTRIBUTION (Candelas)

Degrees Vertical	0°
0	2244
5	2228
15	1641
25	507
35	46
45	2
55	1
65	0
75	0
85	0
90	0

AVERAGE INITIAL FOOTCANDLES

Multiple Units (Square Array, 60"x60' room)

Ceiling 80% Wall 50% Floor 20%

Spacing	RCR1	RCR3	RCR5
4.0'	68	61	56
5.0'	43	39	36
6.0'	30	27	25
7.0'	24	22	20
8.0'	19	17	16
9.0'	15	13	12
10.0'	11	10	9

INITIAL FOOTCANDLES

(One Unit, 14.8W, 39.6° Beam)

Distance to Illuminated Plane (Feet)	Footcandles Beam Center	Beam Diameter
6	62.3	4.3'
8	35.1	5.8'
10	22.4	7.2'
12	15.6	8.6'

ZONAL LUMEN SUMMARY

Zone	Lumens	%Fixture
0-30°	919	95.1
0-40°	962	99.5
0-60°	965	99.9
0-90°	966	100.0

LUMINANCE (Average cd/m²)

Degrees	Average Luminance
45	1509
55	1033
65	561
75	229
85	680

WIDE FLOOD

PHOTOMETRIC REPORT

Test Report #: PT02141103

Catalog No: AX2SQ DR 12LM 30K

80CRI 45D FPC 120

2SQD CD

Luminaire Spacing Criterion: 0.74

Luminaire LPW: 55

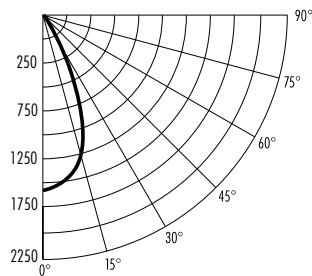

CANDLEPOWER DISTRIBUTION (Candelas)

Degrees Vertical	0°
0	1613
5	1586
15	1257
25	410
35	78
45	4
55	2
65	1
75	0
85	0
90	0

AVERAGE INITIAL FOOTCANDLES

Multiple Units (Square Array, 60"x60' room)

Ceiling 80% Wall 50% Floor 20%

Spacing	RCR1	RCR3	RCR5
4.0'	57	51	47
5.0'	37	33	30
6.0'	26	23	21
7.0'	21	18	17
8.0'	16	15	13
9.0'	13	11	10
10.0'	9	8	7

INITIAL FOOTCANDLES

(One Unit, 14.8W, 42.2° Beam)

Distance to Illuminated Plane (Feet)	Footcandles Beam Center	Beam Diameter
6	44.8	4.6'
8	25.2	6.2'
10	16.1	7.7'
12	11.2	9.3'

ZONAL LUMEN SUMMARY

Zone	Lumens	%Fixture
0-30°	752	91.7
0-40°	812	99.0
0-60°	819	99.8
0-90°	820	100.0

LUMINANCE (Average cd/m²)

Degrees	Average Luminance
45	2682
55	1963
65	1122
75	687
85	680

Fixtures tested to IES recommended standard for solid state lighting per LM-79-08. Photometric performance on a single unit represents a baseline of performance for the fixture. Results may vary in the field. Photometry is at 3000K CCT.

2SQD Square Downlight Reflector

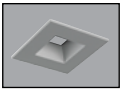

Self-Flanged

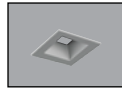

Flangeless



2" LED RECESSED DOWNLIGHT 800/1200 LUMEN

SQUARE DOWNLIGHT REFLECTOR REMODEL 2SQD with WET option

PHOTOMETRICS

SPOT PHOTOMETRIC REPORT

Test Report #: PT02141004

Catalog No: AX2SQ DR 12LM 30K

80CRI 18D FPC 120

2SQD CD WET

Luminaire Spacing Criterion: 0.50

Luminaire LPW: 62

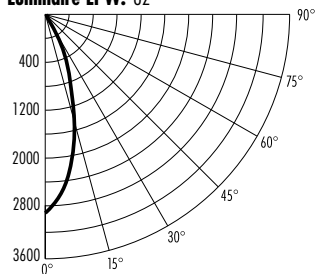

CANDLEPOWER DISTRIBUTION (Candelas)

Degrees Vertical	0°
0	2895
5	2648
15	1368
25	398
35	84
45	19
55	5
65	1
75	0
85	0
90	0

AVERAGE INITIAL FOOTCANDLES

Multiple Units (Square Array, 60'x60' room)

Ceiling 80% Wall 50% Floor 20%

Spacing	RCR1	RCR3	RCR5
4.0'	64	58	53
5.0'	41	37	34
6.0'	29	26	23
7.0'	23	21	19
8.0'	18	16	15
9.0'	14	13	11
10.0'	10	9	8

INITIAL FOOTCANDLES

(One Unit, 14.8W, 29.4° Beam)

Distance to Illuminated Plane (Feet)	Footcandles Beam Center	Beam Diameter
6	80.4	3.1'
8	45.2	4.2'
10	29.0	5.2'
12	20.1	6.3'

ZONAL LUMEN SUMMARY

Zone	Lumens	%Fixture
0-30°	824	89.8
0-40°	892	97.2
0-60°	916	99.8
0-90°	918	100.0

LUMINANCE (Average cd/m²)

Degrees	Average Luminance
45	12656
55	3926
65	1262
75	458
85	680

NARROW FLOOD PHOTOMETRIC REPORT

Test Report #: PT02141008

Catalog No: AX2SQ DR 12LM 30K

80CRI 24D FPC 120

2SQD CD WET

Luminaire Spacing Criterion: 0.52

Luminaire LPW: 56

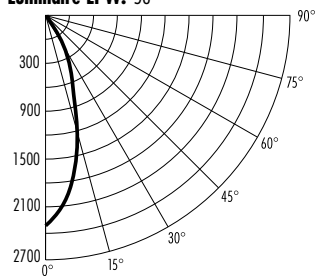

CANDLEPOWER DISTRIBUTION (Candelas)

Degrees Vertical	0°
0	2347
5	2175
15	1218
25	398
35	90
45	20
55	5
65	1
75	0
85	0
90	0

AVERAGE INITIAL FOOTCANDLES

Multiple Units (Square Array, 60'x60' room)

Ceiling 80% Wall 50% Floor 20%

Spacing	RCR1	RCR3	RCR5
4.0'	58	52	47
5.0'	37	33	30
6.0'	26	23	21
7.0'	21	19	17
8.0'	17	15	13
9.0'	13	11	10
10.0'	9	8	8

INITIAL FOOTCANDLES

(One Unit, 14.8W, 31.6° Beam)

Distance to Illuminated Plane (Feet)	Footcandles Beam Center	Beam Diameter
6	65.2	3.4'
8	36.7	4.5'
10	23.5	5.7'
12	16.3	6.8'

ZONAL LUMEN SUMMARY

Zone	Lumens	%Fixture
0-30°	734	88.4
0-40°	804	96.8
0-60°	829	99.8
0-90°	831	100.0

LUMINANCE (Average cd/m²)

Degrees	Average Luminance
45	13494
55	3823
65	1122
75	458
85	0

Fixtures tested to IES recommended standard for solid state lighting per LM-79-08. Photometric performance on a single unit represents a baseline of performance for the fixture. Results may vary in the field. Photometry is at 3000K CCT.

2SQD Square Downlight Reflector

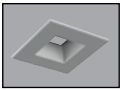

Self-Flanged



Flangeless



2" LED RECESSED DOWNLIGHT 800/1200 LUMEN

SQUARE DOWNLIGHT REFLECTOR REMODEL 2SQD with WET option (continued)

PHOTOMETRICS

FLOOD

PHOTOMETRIC REPORT

Test Report #: PT02141012

Catalog No: AX2SQ DR 12LM 30K

80CRI 35D FPC 120

2SQD CD WET

Luminaire Spacing Criterion: 0.66

Luminaire LPW: 56

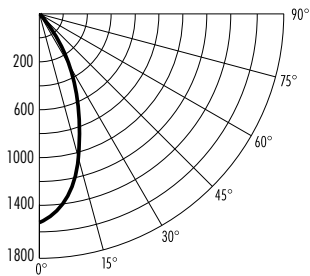

CANDLEPOWER DISTRIBUTION (Candelas)

Degrees Vertical	0°
0	1556
5	1498
15	1078
25	512
35	143
45	25
55	4
65	1
75	0
85	0
90	0

AVERAGE INITIAL FOOTCANDLES

Multiple Units (Square Array, 60'x60' room)

Ceiling 80% Wall 50% Floor 20%

Spacing	RCR1	RCR3	RCR5
4.0'	58	51	45
5.0'	37	33	29
6.0'	26	23	20
7.0'	21	18	16
8.0'	16	15	13
9.0'	13	11	10
10.0'	9	8	7

ZONAL LUMEN SUMMARY

Zone	Lumens	%Fixture
0-30°	679	82.4
0-40°	787	95.5
0-60°	822	99.8
0-90°	824	100.0

INITIAL FOOTCANDLES

(One Unit, 14.8W, 41.0° Beam)

Distance to Illuminated Plane (Feet)	Footcandles Beam Center	Beam Diameter
6	43.2	4.5'
8	24.3	6.0'
10	15.6	7.5'
12	10.8	9.0'

LUMINANCE (Average cd/m²)

Degrees	Average Luminance
45	17014
55	3410
65	1402
75	458
85	0

WIDE FLOOD

PHOTOMETRIC REPORT

Test Report #: PT02141104

Catalog No: AX2SQ DR 12LM 30K

80CRI 45D FPC 120

2SQD CD WET

Luminaire Spacing Criterion: 0.70

Luminaire LPW: 47

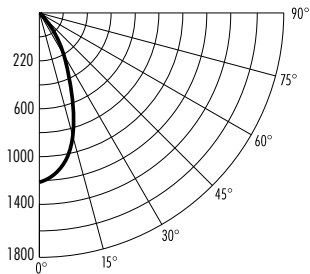

CANDLEPOWER DISTRIBUTION (Candelas)

Degrees Vertical	0°
0	1213
5	1180
15	897
25	434
35	120
45	19
55	5
65	1
75	0
85	0
90	0

AVERAGE INITIAL FOOTCANDLES

Multiple Units (Square Array, 60'x60' room)

Ceiling 80% Wall 50% Floor 20%

Spacing	RCR1	RCR3	RCR5
4.0'	48	43	38
5.0'	31	27	24
6.0'	21	19	17
7.0'	17	15	14
8.0'	14	12	11
9.0'	11	9	8
10.0'	8	7	6

ZONAL LUMEN SUMMARY

Zone	Lumens	%Fixture
0-30°	570	81.9
0-40°	664	95.4
0-60°	694	99.7
0-90°	696	100.0

INITIAL FOOTCANDLES

(One Unit, 14.8W, 43.0° Beam)

Distance to Illuminated Plane (Feet)	Footcandles Beam Center	Beam Diameter
6	33.7	4.7'
8	19.0	6.3'
10	12.1	7.9'
12	8.4	9.5'

LUMINANCE (Average cd/m²)

Degrees	Average Luminance
45	13075
55	4340
65	1683
75	458
85	680

Fixtures tested to IES recommended standard for solid state lighting per LM-79-08. Photometric performance on a single unit represents a baseline of performance for the fixture. Results may vary in the field. Photometry is at 3000K CCT.

2SQDBV Square Downlight Bevel



Self-Flanged

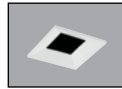

Flangeless



2" LED RECESSED DOWNLIGHT

800/1200 LUMEN

SQUARE DOWNLIGHT BEVEL REMODEL

2SQDBV

PHOTOMETRICS

SPOT PHOTOMETRIC REPORT

Test Report #: PT02141005
 Catalog No: AX2SQ DR 12LM 30K
 80CRI 18D FPC 120
 2SQDBV BD

Luminaire Spacing Criterion: 0.34
 Luminaire LPW: 71

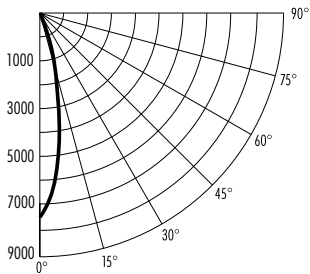

CANDLEPOWER DISTRIBUTION (Candelas)

Degrees Vertical	0°
0	7542
5	6407
15	1398
25	154
35	12
45	1
55	0
65	0
75	0
85	0
90	0

AVERAGE INITIAL FOOTCANDLES

Multiple Units (Square Array, 60'x60' room)
 Ceiling 80% Wall 50% Floor 20%

Spacing	RCR1	RCR3	RCR5
4.0'	75	69	65
5.0'	48	44	42
6.0'	33	31	29
7.0'	27	25	23
8.0'	21	20	19
9.0'	16	15	14
10.0'	12	11	10

ZONAL LUMEN SUMMARY

Zone	Lumens	%Fixture
0-30°	1038	98.6
0-40°	1051	99.8
0-60°	1052	100.0
0-90°	1053	100.0

INITIAL FOOTCANDLES

(One Unit, 14.8W, 19.0° Beam)

Distance to Illuminated Plane (Feet)	Footcandles Beam Center	Beam Diameter
6	209.5	2.0'
8	117.8	2.7'
10	75.4	3.3'
12	52.4	4.0'

LUMINANCE (Average cd/m²)

Degrees	Average Luminance
45	1403
55	576
65	0
75	852
85	0

NARROW FLOOD PHOTOMETRIC REPORT

Test Report #: PT02141009
 Catalog No: AX2SQ DR 12LM 30K
 80CRI 24D FPC 120
 2SQDBV BD

Luminaire Spacing Criterion: 0.36
 Luminaire LPW: 65

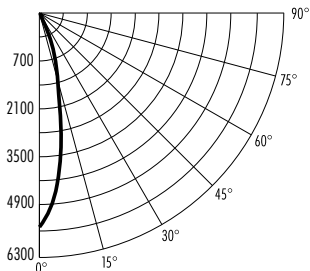

CANDLEPOWER DISTRIBUTION (Candelas)

Degrees Vertical	0°
0	5571
5	4774
15	1436
25	216
35	21
45	3
55	0
65	0
75	0
85	0
90	0

AVERAGE INITIAL FOOTCANDLES

Multiple Units (Square Array, 60'x60' room)
 Ceiling 80% Wall 50% Floor 20%

Spacing	RCR1	RCR3	RCR5
4.0'	68	62	58
5.0'	43	40	37
6.0'	30	28	26
7.0'	24	22	21
8.0'	19	18	17
9.0'	15	14	13
10.0'	11	10	9

ZONAL LUMEN SUMMARY

Zone	Lumens	%Fixture
0-30°	937	97.6
0-40°	956	99.6
0-60°	959	99.9
0-90°	960	100.0

INITIAL FOOTCANDLES

(One Unit, 14.8W, 21.3° Beam)

Distance to Illuminated Plane (Feet)	Footcandles Beam Center	Beam Diameter
6	154.8	2.3'
8	87.0	3.0'
10	55.7	3.8'
12	38.7	4.5'

LUMINANCE (Average cd/m²)

Degrees	Average Luminance
45	3429
55	769
65	1043
75	2129
85	0

Fixtures tested to IES recommended standard for solid state lighting per LM-79-08. Photometric performance on a single unit represents a baseline of performance for the fixture. Results may vary in the field. Photometry is at 3000K CCT.

2SQDBV Square Downlight Bevel

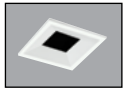

Self-Flanged

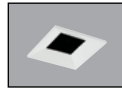

Flangeless



2" LED RECESSED DOWNLIGHT

800/1200 LUMEN

SQUARE DOWNLIGHT BEVEL REMODEL

2SQDBV (continued)

PHOTOMETRICS

FLOOD PHOTOMETRIC REPORT

Test Report #: PT02141101

Catalog No: AX2SQ DR 12LM 30K

80CRI 35D FPC 120

2SQDBV BD

Luminaire Spacing Criterion: 0.68

Luminaire LPW: 62

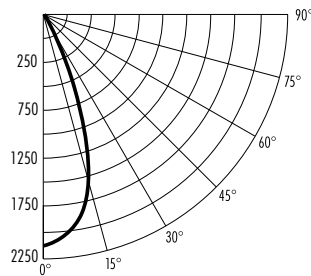

CANDLEPOWER DISTRIBUTION (Candelas)

Degrees	Candelas
Vertical	0°
0	2118
5	2101
15	1580
25	482
35	52
45	2
55	0
65	0
75	0
85	0
90	0

AVERAGE INITIAL FOOTCANDLES

Multiple Units (Square Array, 60'x60' room)

Ceiling 80% Wall 50% Floor 20%

Spacing	RCR1	RCR3	RCR5
4.0'	65	58	53
5.0'	41	37	34
6.0'	29	26	24
7.0'	23	21	19
8.0'	18	17	15
9.0'	14	13	12
10.0'	10	9	8

ZONAL LUMEN SUMMARY

Zone	Lumens	%Fixture
0-30°	873	94.7
0-40°	918	99.5
0-60°	922	99.9
0-90°	923	100.0

INITIAL FOOTCANDLES (One Unit, 14.8W, 39.8° Beam)

Distance to Illuminated Plane (Feet)	Footcandles Beam Center	Beam Diameter
6	58.8	4.3'
8	33.1	5.8'
10	21.2	7.2'
12	14.7	8.7'

LUMINANCE (Average cd/m²)

Degrees	Average Luminance
45	2805
55	769
65	1043
75	852
85	0

WIDE FLOOD PHOTOMETRIC REPORT

Test Report #: PT02141105

Catalog No: AX2SQ DR 12LM 30K

80CRI 45D FPC 120

2SQDBV BD

Luminaire Spacing Criterion: 0.74

Luminaire LPW: 51

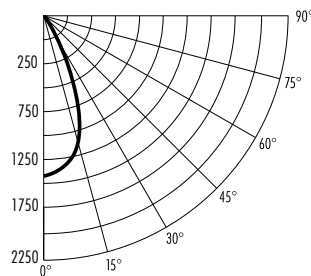

CANDLEPOWER DISTRIBUTION (Candelas)

Degrees	Candelas
Vertical	0°
0	1424
5	1386
15	1156
25	388
35	91
45	2
55	1
65	1
75	1
85	0
90	0

AVERAGE INITIAL FOOTCANDLES

Multiple Units (Square Array, 60'x60' room)

Ceiling 80% Wall 50% Floor 20%

Spacing	RCR1	RCR3	RCR5
4.0'	52	47	42
5.0'	34	30	27
6.0'	23	21	19
7.0'	19	17	15
8.0'	15	13	12
9.0'	11	10	9
10.0'	8	7	7

ZONAL LUMEN SUMMARY

Zone	Lumens	%Fixture
0-30°	674	89.9
0-40°	739	98.7
0-60°	748	99.8
0-90°	749	100.0

INITIAL FOOTCANDLES (One Unit, 14.8W, 42.5° Beam)

Distance to Illuminated Plane (Feet)	Footcandles Beam Center	Beam Diameter
6	39.6	4.7'
8	22.3	6.2'
10	14.2	7.8'
12	9.9	9.3'

LUMINANCE (Average cd/m²)

Degrees	Average Luminance
45	2338
55	1345
65	1825
75	2555
85	1264

Fixtures tested to IES recommended standard for solid state lighting per LM-79-08. Photometric performance on a single unit represents a baseline of performance for the fixture. Results may vary in the field. Photometry is at 3000K CCT.

2SQDBV Square Downlight Bevel



Self-Flanged

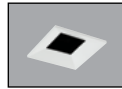

Flangeless



2" LED RECESSED DOWNLIGHT

800/1200 LUMEN

SQUARE DOWNLIGHT BEVEL REMODEL

2SQDBV with WET option

PHOTOMETRICS

SPOT PHOTOMETRIC REPORT

Test Report #: PTO2141006

Catalog No: AX2SQ DR 12LM 30K

80CRI 18D FPC 120

2SQDBV BD WET

Luminaire Spacing Criterion: 0.34

Luminaire LPW: 64

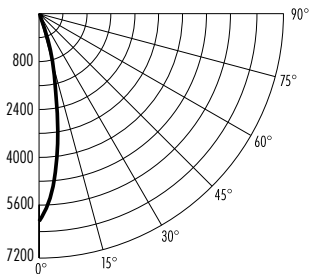

CANDLEPOWER DISTRIBUTION (Candelas)

Degrees	Candelas
Vertical	0°
0	6297
5	5305
15	1314
25	173
35	17
45	3
55	1
65	1
75	1
85	0
90	0

AVERAGE INITIAL FOOTCANDLES

Multiple Units (Square Array, 60'x60' room)

Ceiling 80% Wall 50% Floor 20%

Spacing	RCR1	RCR3	RCR5
4.0'	67	62	58
5.0'	43	40	37
6.0'	30	28	26
7.0'	24	22	21
8.0'	19	18	17
9.0'	15	14	13
10.0'	11	10	9

INITIAL FOOTCANDLES

(One Unit, 14.8W, 19.6° Beam)

Distance to Illuminated Plane (Feet)	Footcandles Beam Center	Beam Diameter
6	174.9	2.1'
8	98.4	2.8'
10	63.0	3.5'
12	43.7	4.1'

ZONAL LUMEN SUMMARY

Zone	Lumens	%Fixture
0-30°	926	97.7
0-40°	942	99.4
0-60°	947	99.8
0-90°	948	100.0

LUMINANCE (Average cd/m²)

Degrees	Average Luminance
45	4208
55	2113
65	1565
75	2129
85	1264

NARROW FLOOD PHOTOMETRIC REPORT

Test Report #: PTO2141010

Catalog No: AX2SQ DR 12LM 30K

80CRI 24D FPC 120

2SQDBV BD WET

Luminaire Spacing Criterion: 0.38

Luminaire LPW: 58

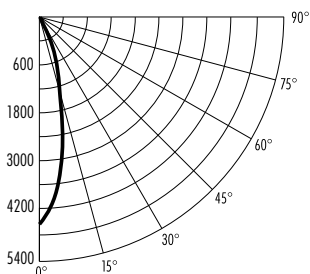

CANDLEPOWER DISTRIBUTION (Candelas)

Degrees	Candelas
Vertical	0°
0	4636
5	3997
15	1317
25	219
35	25
45	4
55	1
65	1
75	1
85	0
90	0

AVERAGE INITIAL FOOTCANDLES

Multiple Units (Square Array, 60'x60' room)

Ceiling 80% Wall 50% Floor 20%

Spacing	RCR1	RCR3	RCR5
4.0'	61	56	52
5.0'	39	36	33
6.0'	27	25	23
7.0'	22	20	19
8.0'	17	16	15
9.0'	13	12	11
10.0'	10	9	8

INITIAL FOOTCANDLES

(One Unit, 14.8W, 22.0° Beam)

Distance to Illuminated Plane (Feet)	Footcandles Beam Center	Beam Diameter
6	128.8	2.3'
8	72.4	3.1'
10	46.4	3.9'
12	32.2	4.7'

ZONAL LUMEN SUMMARY

Zone	Lumens	%Fixture
0-30°	831	96.6
0-40°	853	99.2
0-60°	858	99.8
0-90°	860	100.0

LUMINANCE (Average cd/m²)

Degrees	Average Luminance
45	5143
55	2306
65	2086
75	2555
85	0

Fixtures tested to IES recommended standard for solid state lighting per LM-79-08. Photometric performance on a single unit represents a baseline of performance for the fixture. Results may vary in the field. Photometry is at 3000K CCT.

2SQDBV Square Downlight Bevel



Self-Flanged

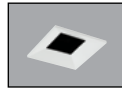

Flangeless



2" LED RECESSED DOWNLIGHT

800/1200 LUMEN

SQUARE DOWNLIGHT BEVEL REMODEL

2SQDBV with WET option (continued)

PHOTOMETRICS

FLOOD

PHOTOMETRIC REPORT

Test Report #: PT02141102

Catalog No: AX2SQ DR 12LM 30K

80CRI 35D FPC 120

2SQDBV BD WET

Luminaire Spacing Criterion: 0.66

Luminaire LPW: 56

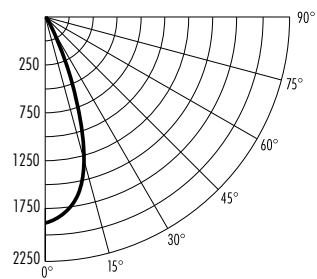

CANDLEPOWER DISTRIBUTION (Candelas)

Degrees Vertical	0°
0	1879
5	1843
15	1369
25	456
35	59
45	5
55	1
65	1
75	0
85	0
90	0

AVERAGE INITIAL FOOTCANDLES

Multiple Units (Square Array, 60'x60' room)

Ceiling 80% Wall 50% Floor 20%

Spacing	RCR1	RCR3	RCR5
4.0'	58	52	48
5.0'	37	33	30
6.0'	26	23	21
7.0'	21	19	17
8.0'	16	15	14
9.0'	13	11	10
10.0'	9	8	8

INITIAL FOOTCANDLES

(One Unit, 14.8W, 39.3° Beam)

Distance to Illuminated Plane (Feet)	Footcandles Beam Center	Beam Diameter
6	52.2	4.3'
8	29.4	5.7'
10	18.8	7.1'
12	13.0	8.6'

ZONAL LUMEN SUMMARY

Zone	Lumens	%Fixture
0-30°	768	92.9
0-40°	817	98.9
0-60°	825	99.8
0-90°	827	100.0

LUMINANCE (Average cd/m²)

Degrees	Average Luminance
45	6546
55	2306
65	1825
75	1703
85	0

WIDE FLOOD

PHOTOMETRIC REPORT

Test Report #: PT02141106

Catalog No: AX2SQ DR 12LM 30K

80CRI 35D FPC 120

2SQDBV BD WET

Luminaire Spacing Criterion: 0.72

Luminaire LPW: 45

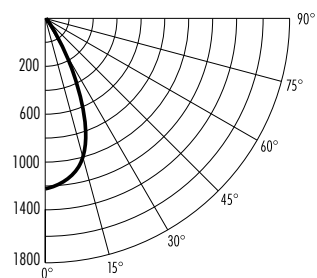

CANDLEPOWER DISTRIBUTION (Candelas)

Degrees Vertical	0°
0	1240
5	1213
15	1002
25	369
35	82
45	7
55	2
65	1
75	1
85	0
90	0

AVERAGE INITIAL FOOTCANDLES

Multiple Units (Square Array, 60'x60' room)

Ceiling 80% Wall 50% Floor 20%

Spacing	RCR1	RCR3	RCR5
4.0'	46	42	37
5.0'	30	27	24
6.0'	21	18	17
7.0'	17	15	13
8.0'	13	12	11
9.0'	10	9	8
10.0'	7	7	6

INITIAL FOOTCANDLES

(One Unit, 14.8W, 42.2° Beam)

Distance to Illuminated Plane (Feet)	Footcandles Beam Center	Beam Diameter
6	34.4	4.6'
8	19.4	6.2'
10	12.4	7.7'
12	8.6	9.3'

ZONAL LUMEN SUMMARY

Zone	Lumens	%Fixture
0-30°	587	88.4
0-40°	649	97.7
0-60°	662	99.7
0-90°	664	100.0

LUMINANCE (Average cd/m²)

Degrees	Average Luminance
45	8416
55	2882
65	2608
75	2555
85	0

Fixtures tested to IES recommended standard for solid state lighting per LM-79-08. Photometric performance on a single unit represents a baseline of performance for the fixture. Results may vary in the field. Photometry is at 3000K CCT.

2SQDPIN Square Downlight Pinhole



Self-Flanged



Flangeless



2" LED RECESSED DOWNLIGHT

800/1200 LUMEN

SQUARE 1 1/4" DOWNLIGHT PINHOLE REMODEL

2SQDPIN

PHOTOMETRICS

SPOT

PHOTOMETRIC REPORT

Test Report #: PT02141005

Catalog No: AX2SQ DR 12LM 30K

80CRI 18D FPC 120

2SQDPIN BD

Luminaire Spacing Criterion: 0.34

Luminaire LPW: 71

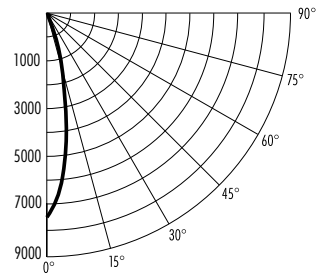

CANDLEPOWER DISTRIBUTION (Candelas)

Degrees	Candelas
Vertical 0°	0
0	7542
5	6407
15	1398
25	154
35	12
45	1
55	0
65	0
75	0
85	0
90	0

AVERAGE INITIAL FOOTCANDLES

Multiple Units (Square Array, 60'x60' room)

Ceiling 80% Wall 50% Floor 20%

Spacing	RCR1	RCR3	RCR5
4.0'	75	69	65
5.0'	48	44	42
6.0'	33	31	29
7.0'	27	25	23
8.0'	21	20	19
9.0'	16	15	14
10.0'	12	11	10

ZONAL LUMEN SUMMARY

Zone	Lumens	%Fixture
0-30°	1038	98.6
0-40°	1051	99.8
0-60°	1052	100.0
0-90°	1053	100.0

INITIAL FOOTCANDLES

(One Unit, 14.8W, 19.0° Beam)

Distance to Illuminated Plane (Feet)	Footcandles Beam Center	Beam Diameter
6	209.5	2.0'
8	117.8	2.7'
10	75.4	3.3'
12	52.4	4.0'

LUMINANCE (Average cd/m²)

Degrees	Average Luminance
45	1403
55	576
65	0
75	852
85	0

NARROW FLOOD

PHOTOMETRIC REPORT

Test Report #: PT02141009

Catalog No: AX2SQ DR 12LM 30K

80CRI 24D FPC 120

2SQDPIN BD

Luminaire Spacing Criterion: 0.36

Luminaire LPW: 65

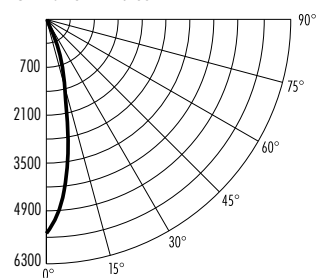

CANDLEPOWER DISTRIBUTION (Candelas)

Degrees	Candelas
Vertical 0°	0
0	5571
5	4774
15	1436
25	216
35	21
45	3
55	0
65	0
75	0
85	0
90	0

AVERAGE INITIAL FOOTCANDLES

Multiple Units (Square Array, 60'x60' room)

Ceiling 80% Wall 50% Floor 20%

Spacing	RCR1	RCR3	RCR5
4.0'	68	62	58
5.0'	43	40	37
6.0'	30	28	26
7.0'	24	22	21
8.0'	19	18	17
9.0'	15	14	13
10.0'	11	10	9

ZONAL LUMEN SUMMARY

Zone	Lumens	%Fixture
0-30°	937	97.6
0-40°	956	99.6
0-60°	959	99.9
0-90°	960	100.0

INITIAL FOOTCANDLES

(One Unit, 14.8W, 21.3° Beam)

Distance to Illuminated Plane (Feet)	Footcandles Beam Center	Beam Diameter
6	154.8	2.3'
8	87.0	3.0'
10	55.7	3.8'
12	38.7	4.5'

LUMINANCE (Average cd/m²)

Degrees	Average Luminance
45	3429
55	769
65	1043
75	2129
85	0

Fixtures tested to IES recommended standard for solid state lighting per LM-79-08. Photometric performance on a single unit represents a baseline of performance for the fixture. Results may vary in the field. Photometry is at 3000K CCT.

2SQDPIN Square Downlight Pinhole



Self-Flanged



Flangeless



2" LED RECESSED DOWNLIGHT

800/1200 LUMEN

SQUARE 1 1/4" DOWNLIGHT PINHOLE REMODEL

2SQDPIN (continued)

PHOTOMETRICS

FLOOD

PHOTOMETRIC REPORT

Test Report #: PT02141101

Catalog No: AX2SQ DR 12LM 30K

80CRI 35D FPC 120

2SQDPIN BD

Luminaire Spacing Criterion: 0.68

Luminaire LPW: 62

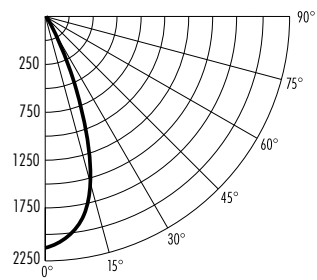

CANDLEPOWER DISTRIBUTION (Candelas)

Degrees	Candelas
Vertical 0°	0
0	2118
5	2101
15	1580
25	482
35	52
45	2
55	0
65	0
75	0
85	0
90	0

AVERAGE INITIAL FOOTCANDLES

Multiple Units (Square Array, 60'x60' room)

Ceiling 80% Wall 50% Floor 20%

Spacing	RCR1	RCR3	RCR5
4.0'	65	58	53
5.0'	41	37	34
6.0'	29	26	24
7.0'	23	21	19
8.0'	18	17	15
9.0'	14	13	12
10.0'	10	9	8

ZONAL LUMEN SUMMARY

Zone	Lumens	%Fixture
0-30°	873	94.7
0-40°	918	99.5
0-60°	922	99.9
0-90°	923	100.0

INITIAL FOOTCANDLES

(One Unit, 14.8W, 39.8° Beam)

Distance to Illuminated Plane (Feet)	Footcandles Beam Center	Beam Diameter
6	58.8	4.3'
8	33.1	5.8'
10	21.2	7.2'
12	14.7	8.7'

LUMINANCE (Average cd/m²)

Degrees	Average Luminance
45	2805
55	769
65	1043
75	852
85	0

WIDE FLOOD

PHOTOMETRIC REPORT

Test Report #: PT02141105

Catalog No: AX2SQ DR 12LM 30K

80CRI 35D FPC 120

2SQDPIN BD

Luminaire Spacing Criterion: 0.74

Luminaire LPW: 51

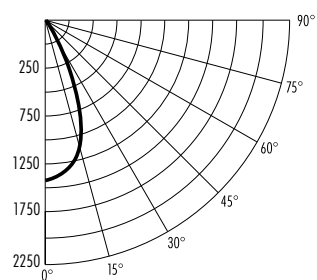

CANDLEPOWER DISTRIBUTION (Candelas)

Degrees	Candelas
Vertical 0°	0
0	1424
5	1386
15	1156
25	388
35	91
45	2
55	1
65	1
75	1
85	0
90	0

AVERAGE INITIAL FOOTCANDLES

Multiple Units (Square Array, 60'x60' room)

Ceiling 80% Wall 50% Floor 20%

Spacing	RCR1	RCR3	RCR5
4.0'	52	47	42
5.0'	34	30	27
6.0'	23	21	19
7.0'	19	17	15
8.0'	15	13	12
9.0'	11	10	9
10.0'	8	7	7

ZONAL LUMEN SUMMARY

Zone	Lumens	%Fixture
0-30°	674	89.9
0-40°	739	98.7
0-60°	748	99.8
0-90°	749	100.0

INITIAL FOOTCANDLES

(One Unit, 14.8W, 42.5° Beam)

Distance to Illuminated Plane (Feet)	Footcandles Beam Center	Beam Diameter
6	39.6	4.7'
8	22.3	6.2'
10	14.2	7.8'
12	9.9	9.3'

LUMINANCE (Average cd/m²)

Degrees	Average Luminance
45	2338
55	1345
65	1825
75	2555
85	1264

Fixtures tested to IES recommended standard for solid state lighting per LM-79-08. Photometric performance on a single unit represents a baseline of performance for the fixture. Results may vary in the field. Photometry is at 3000K CCT.

2SQDPIN Square Downlight Pinhole



Self-Flanged



Flangeless



2" LED RECESSED DOWNLIGHT 800/1200 LUMEN

SQUARE 1 1/4" DOWNLIGHT PINHOLE REMODEL 2SQDPIN with WET option

PHOTOMETRICS

SPOT PHOTOMETRIC REPORT

Test Report #: PT10140801R
Catalog No: AX2SQ DR 12LM 30K
80CRI 18D FPC 120
2SQDPIN BD WET
Luminaire Spacing Criterion: 0.30
Luminaire LPW: 56

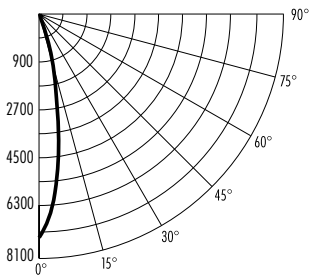

CANDLEPOWER DISTRIBUTION (Candelas)

Degrees	Candelas
Vertical 0°	0
0	7382
5	5929
15	938
25	67
35	8
45	0
55	0
65	0
75	0
85	0
90	0

AVERAGE INITIAL FOOTCANDLES Multiple Units (Square Array, 60'x60' room) Ceiling 80% Wall 50% Floor 20%

Spacing	RCR1	RCR3	RCR5
4.0'	59	55	52
5.0'	38	35	33
6.0'	26	24	23
7.0'	21	20	19
8.0'	17	16	15
9.0'	13	12	11
10.0'	9	9	8

INITIAL FOOTCANDLES (One Unit, 14.8W, 17.1° Beam)

Distance to Illuminated Plane (Feet)	Footcandles Beam Center	Beam Diameter
6	205.1	1.8'
8	115.3	2.4'
10	73.8	3.0'
12	51.3	3.6'

ZONAL LUMEN SUMMARY

Zone	Lumens	%Fixture
0-30°	822	99.0
0-40°	829	99.8
0-60°	831	100.0
0-90°	831	100.0

LUMINANCE (Average cd/m²)

Degrees	Average Luminance
45	754
55	465
65	316
75	515
85	0

NARROW FLOOD PHOTOMETRIC REPORT

Test Report #: PT10140803R
Catalog No: AX2SQ DR 12LM 30K
80CRI 24D FPC 120
2SQDPIN BD WET
Luminaire Spacing Criterion: 0.34
Luminaire LPW: 51

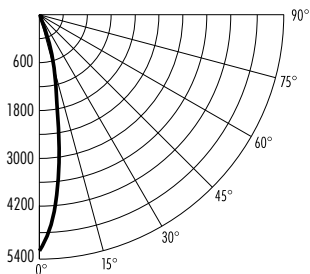

CANDLEPOWER DISTRIBUTION (Candelas)

Degrees	Candelas
Vertical 0°	0
0	5126
5	4246
15	1076
25	101
35	14
45	1
55	0
65	0
75	0
85	0
90	0

AVERAGE INITIAL FOOTCANDLES Multiple Units (Square Array, 60'x60' room) Ceiling 80% Wall 50% Floor 20%

Spacing	RCR1	RCR3	RCR5
4.0'	53	49	46
5.0'	34	32	30
6.0'	24	22	20
7.0'	19	18	17
8.0'	15	14	13
9.0'	12	11	10
10.0'	9	8	7

INITIAL FOOTCANDLES (One Unit, 14.8W, 20.1° Beam)

Distance to Illuminated Plane (Feet)	Footcandles Beam Center	Beam Diameter
6	142.4	2.1'
8	80.1	2.8'
10	51.3	3.5'
12	35.6	4.3'

ZONAL LUMEN SUMMARY

Zone	Lumens	%Fixture
0-30°	740	98.3
0-40°	751	99.7
0-60°	752	100.0
0-90°	753	100.0

LUMINANCE (Average cd/m²)

Degrees	Average Luminance
45	1131
55	465
65	316
75	515
85	0

Fixtures tested to IES recommended standard for solid state lighting per LM-79-08. Photometric performance on a single unit represents a baseline of performance for the fixture. Results may vary in the field. Photometry is at 3000K CCT.

2SQDPIN Square Downlight Pinhole



Self-Flanged



Flangeless



2" LED RECESSED DOWNLIGHT

800/1200 LUMEN

SQUARE 1 1/4" DOWNLIGHT PINHOLE REMODEL

2SQDPIN with WET option (continued)

PHOTOMETRICS

FLOOD PHOTOMETRIC REPORT

Test Report #: PT10140805R

Catalog No: AX2SQ DR 12LM 30K

80CRI 35D FPC 120

2SQDPIN BD WET

Luminaire Spacing Criterion: 0.60

Luminaire LPW: 61

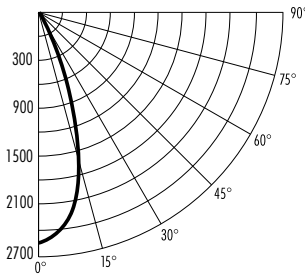

CANDLEPOWER DISTRIBUTION (Candelas)

Degrees Vertical	0°
0	2592
5	2497
15	1654
25	355
35	29
45	1
55	0
65	0
75	0
85	0
90	0

AVERAGE INITIAL FOOTCANDLES

Multiple Units (Square Array, 60'x60' room)

Ceiling 80% Wall 50% Floor 20%

Spacing	RCR1	RCR3	RCR5
4.0'	64	58	53
5.0'	41	37	34
6.0'	28	26	24
7.0'	23	21	19
8.0'	18	16	15
9.0'	14	13	12
10.0'	10	9	9

INITIAL FOOTCANDLES

(One Unit, 14.8W, 35.2° Beam)

Distance to Illuminated Plane (Feet)	Footcandles Beam Center	Beam Diameter
6	72.0	3.8'
8	40.5	5.1'
10	25.9	6.3'
12	18.0	7.6'

ZONAL LUMEN SUMMARY

Zone	Lumens	%Fixture
0-30°	875	96.7
0-40°	903	99.8
0-60°	905	100.0
0-90°	905	100.0

LUMINANCE (Average cd/m²)

Degrees	Average Luminance
45	1131
55	465
65	316
75	515
85	0

WIDE FLOOD PHOTOMETRIC REPORT

Test Report #: PT10140807R

Catalog No: AX2SQ DR 12LM 30K

80CRI 45D FPC 120

2SQDPIN BD WET

Luminaire Spacing Criterion: 0.62

Luminaire LPW: 46

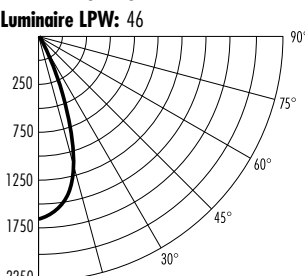

CANDLEPOWER DISTRIBUTION (Candelas)

Degrees Vertical	0°
0	1696
5	1625
15	1135
25	283
35	54
45	1
55	0
65	0
75	0
85	0
90	0

AVERAGE INITIAL FOOTCANDLES

Multiple Units (Square Array, 60'x60' room)

Ceiling 80% Wall 50% Floor 20%

Spacing	RCR1	RCR3	RCR5
4.0'	42	37	34
5.0'	27	24	22
6.0'	19	17	15
7.0'	15	13	12
8.0'	12	11	10
9.0'	9	8	7
10.0'	7	6	5

INITIAL FOOTCANDLES

(One Unit, 14.8W, 36° Beam)

Distance to Illuminated Plane (Feet)	Footcandles Beam Center	Beam Diameter
6	47.1	3.9'
8	26.5	5.2'
10	17.0	6.5'
12	11.8	7.8'

ZONAL LUMEN SUMMARY

Zone	Lumens	%Fixture
0-30°	634	92.7
0-40°	681	99.6
0-60°	684	100.0
0-90°	684	100.0

LUMINANCE (Average cd/m²)

Degrees	Average Luminance
45	1509
55	465
65	316
75	1030
85	0

Fixtures tested to IES recommended standard for solid state lighting per LM-79-08. Photometric performance on a single unit represents a baseline of performance for the fixture. Results may vary in the field. Photometry is at 3000K CCT.