

Project		Catalog #		Type	
Prepared by		Notes		Date	



Lumark

Prevail LED

Area / Site Luminaire

Product Features



Interactive Menu

- Ordering Information [page 2](#)
- Mounting Details [page 3, 4](#)
- Optical Configurations [page 5](#)
- Product Specifications [page 5](#)
- Energy and Performance Data [page 6, 7](#)
- Control Options [page 8](#)

Quick Facts

- Lumen packages range from 4,800 - 84,000 lumens (35W - 588W)
- Replaces 70W up to 1,000W HID equivalents
- Efficacies up to 160 lumens per watt
- Energy and maintenance savings up to 85% versus HID solutions
- Standard universal quick mount arm with universal drill pattern

Dimensional Details

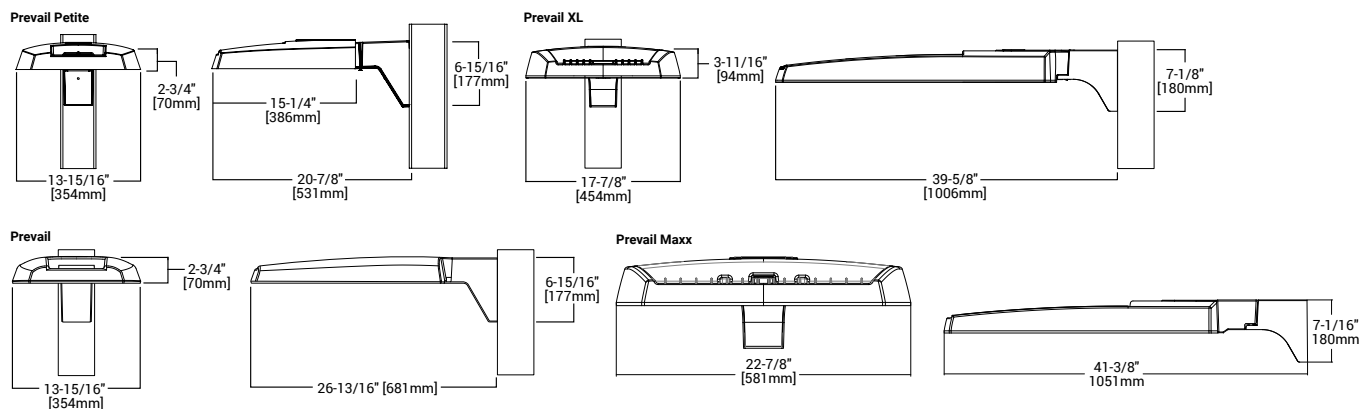

NOTES:
 1. Visit <https://www.designlights.org/search/> to confirm qualification. Not all product variations are DLC qualified.
 2. IDA Certified for 3000K CCT and warmer only.

Product Certifications



Connected Systems

- WaveLinX

Ordering Information

SAMPLE NUMBER: PRV-XL-C75-D-UNV-T4-SA-BZ

Product Family ^{1,2}	Light Engine ⁴	Color Temperature	Driver	Voltage	Distribution	Mounting	Color
PRV-P=Prevail Petite BAA-PRV-P=Prevail Petite BAA Compliant ³ TAA-PRV-P=Prevail Petite TAA Compliant ³	C10=(1 LED) 4,900 Nominal Lumens C15=(1 LED) 6,900 Nominal Lumens C20=(1 LED) 9,800 Nominal Lumens C25=(1 LED) 11,800 Nominal Lumens	740=70CRI, 4000K 727=70CRI, 2700K 730=70CRI, 3000K 750=70CRI, 5000K 8540=85CRI, 4000K	D=Dimming (0-10V)	UNV=Universal (120-277V) H=High Voltage, 347-480V 8=480V ⁵ 9=347V DV=DuraVolt (277-480V) ^{5,6}	T2=Type II T3=Type III T4=Type IV T5=Type V	SA=QM Standard Versatile Arm MA=QM Mast Arm FMA= Fixed Mast Arm ²⁸ WM=QM Wall Mount Arm ADJA-WM=Adjustable Arm-Wall Mount ³⁰ ADJA=Adjustable Arm-Pole Mount ³⁰ ADJS=Adjustable Arm-Slipfitter, 3" vertical tenon ³⁰ SP2=Adjustable Arm-Slipfitter, 2 3/8" vertical tenon ^{28,30}	BZ=Bronze AP=Grey BK=Black DP=Dark Platinum GM=Graphite Metallic WH=White
PRV=Prevail BAA-PRV=Prevail BAA Compliant ³ TAA-PRV=Prevail TAA Compliant ³	C15=(1 LED) 7,100 Nominal Lumens C25=(2 LEDs) 13,100 Nominal Lumens C40=(2 LEDs) 17,100 Nominal Lumens C60=(2 LEDs) 20,000 Nominal Lumens						
PRV-XL=Prevail XL BAA-PRV-XL=Prevail XL BAA Compliant ³ TAA-PRV-XL=Prevail XL TAA Compliant ³	C75=(4 LED) 26,100 Nominal Lumens C100=(4 LED) 31,000 Nominal Lumens C125=(4 LED) 36,000 Nominal Lumens C150=(6 LED) 41,100 Nominal Lumens C175=(6 LED) 48,600 Nominal Lumens						
PRV-M=Prevail Maxx BAA-PRV-M=Prevail Maxx BAA Compliant ³ TAA-PRV-M=Prevail MaxxTAA Compliant ³	C200=(9 LED) 48,000 Nominal Lumens C225=(9 LED) 56,000 Nominal Lumens C250=(9 LED) 65,000 Nominal Lumens C275=(9 LED) 73,000 Nominal Lumens						

Options (Add as Suffix)		Accessories (Order Separately) ^{20,21}	
7030=70 CRI / 3000K CCT ⁷ 7050=70 CRI / 5000K CCT ⁷ CC=Coastal Construction finish ³¹ HSS=House Side Shield ⁸ L90=Optics Rotated 90° Left R90=Optics Rotated 90° Right 10K=10kV/10kA UL 1449 Fused Surge Protective Device 20MSP=20kV MOV Surge Protective Device 20K=20kV UL 1449 Fused Surge Protective Device HA=50°C High Ambient Temperature ⁹ PR=NEMA 3-PIN Twistlock Photocontrol Receptacle ¹¹ PR7=NEMA 7-PIN Twistlock Photocontrol Receptacle ¹¹ MS/DIM-L08=Dimming Motion and Daylight Sensor, IR Remote Programmable, < 8' Mounting Height ^{12,13,22,28} MS/DIM-L20=Dimming Motion and Daylight Sensor, IR Remote Programmable, 8' - 20' Mounting Height ^{12,22,13} MS/DIM-L40=Dimming Motion and Daylight Sensor, IR Remote Programmable, 21' - 40' Mounting Height ^{12,13}	SPB1=Dimming Motion and Daylight Sensor, Bluetooth Programmable, < 8' Mounting Height ^{12,14,22} SPB2=Dimming Motion and Daylight Sensor, Bluetooth Programmable, 8' - 20' Mounting Height ^{12,14,22} SPB4=Dimming Motion and Daylight Sensor, Bluetooth Programmable, 21' - 40' Mounting Height ^{12,14,28,29} ZW=WaveLinx-enabled 4-PIN Twistlock Receptacle ¹² ZD=DALI-enabled 4-PIN Twistlock Receptacle ¹² ZW-SWPD4XX=WaveLinx Pro, Dimming Motion and Daylight, WAC Programmable, 7' - 15' Mounting ^{12,15,16,17,22} ZW-SWPD5XX=WaveLinx Pro, Dimming Motion and Daylight, WAC Programmable, 15' - 40' Mounting ^{12,15,16,17,28,29} ZD-SWPD4XX= WaveLinx Pro, SR Driver, Dimming Motion and Daylight, WAC Programmable, 7' - 15' Mounting ^{12,15,16,17,22} ZD-SWPD5XX=WaveLinx Pro, SR Driver, Dimming Motion and Daylight, WAC Programmable, 15' - 40' Mounting ^{12,15,16,17,28,29} (See Table Below)=LumenSafe Integrated Network Security Camera ^{18,19}	PRVSA-XX=Standard Arm Mounting Kit ²² PRVMA-XX=Mast Arm Mounting Kit ²² PRVWM-XX=Wall Mount Kit ²² PRV-ADJA-XX=Adjustable Arm - Pole Mount Kit ²² PRV-ADJS-XX=Adjustable Arm - Slipfitter Kit ²² PRV-ADJA-WM-XX=Adjustable Arm - Wall Mount Kit ²² PRVXLSA-XX=Standard Arm Mounting Kit ²⁹ PRVXLMA-XX=Mast Arm Mounting Kit ²⁹ PRVXLWM-XX=Wall Mount Kit ²⁹ PRV-XL-ADJA-XX=Adjustable Arm - Pole Mount Kit ²⁹ PRV-XL-ADJS-XX=Adjustable Arm - Slipfitter Kit ²⁹ PRV-XL-ADJA-WM-XX=Adjustable Arm - Wall Mount Kit ²⁹ PRV-M-ADJA-XX=Adjustable Arm - Pole Mount Kit ²⁸ PRV-M-ADJS-XX=Adjustable Arm - Slipfitter Kit ²⁸ PRV-M-ADJA-WM-XX=Adjustable Arm - Wall Mount Kit ²⁸ MA1010-XX=Single Tenon Adapter for 3-1/2" O.D. Tenon MA1011-XX=2@180° Tenon Adapter for 3-1/2" O.D. Tenon	MA1017-XX=Single Tenon Adapter for 2-3/8" O.D. Tenon MA1018-XX=2@180° Tenon Adapter for 2-3/8" O.D. Tenon SRA238=Tenon Adapter from 3" to 2-3/8" PRV/COB-FDV=Full Drop Visor ²³ PRVXL/COB-FDV=Full Drop Visor ¹⁸ HS/VERD=House Side Shield Kit ^{8,24} VGS-F/B= Vertical Glare Shield Kit, Front/Back ²⁴ VGS-SIDE=Vertical Glare Shield Kit, Side ²⁴ OA/RA1013=Photocontrol Shorting Cap OA/RA1014=NEMA Photocontrol - 120V OA/RA1016=NEMA Photocontrol - Multi-Tap 105-285V OA/RA1201=NEMA Photocontrol - 347V OA/RA1027=NEMA Photocontrol - 480V FSIR-100=Wireless Configuration Tool for Occupancy Sensor ²⁵ WOLC-7P-10A=WaveLinx Outdoor Control Module (7-PIN) ²⁷ SWPD4-XX=WaveLinx Sensor, Dimming Motion and Daylight, WAC Programmable, 7' - 15' Mounting ^{15,16,17,22,26} SWPD5-XX=WaveLinx Sensor, Dimming Motion and Daylight, WAC Programmable, 15' - 40' Mounting ^{15,16,17,26,28,29}

- NOTES:**
- DesignLights Consortium® Qualified. Refer to www.designlights.org Qualified Products List under Family Models for details.
 - Customer is responsible for engineering analysis to confirm pole and fixture compatibility for all applications. Refer to installation instructions IB500002EN and pole white paper WP513001EN for additional support information.
 - Only product configurations with these designated prefixes are built to be compliant with the Buy American Act of 1933 (BAA) or Trade Agreements Act of 1979 (TAA), respectively. Please refer to DOMESTIC.PREFERENCES website for more information. Components shipped separately may be separately analyzed under domestic preference requirements.
 - Standard 4000K CCT and 70CRI.
 - 480V not to be used with ungrounded or impedance grounded systems.
 - DuraVolt drivers feature added protection from power quality issues such as loss of neutral, transients and voltage fluctuations. Visit www.signify.com/duravolt for more information.
 - Use dedicated IES files on product website for non-standard CCTs.
 - House Side Shield not suitable with T5 distribution. Not available with PRV-C60 lumen package.
 - Not available with PRV-C60 lumen package. Not available with PRV-P-C25 lumen package.
 - Coastal construction finish salt spray tested to over 5,000-hours per ASTM B117, with a scribe rating of 9 per ASTM D1654.
 - If DuraVolt (DV) is specified, use a photocontrol that matches the input voltage used.
 - Controls system is not available in combination with a photocontrol receptacle (PR & PER7) or another controls system (MS, SPB, ZD, or ZW). Option not available with DuraVolt (DV) voltage option.
 - Utilizes the Wattstopper sensor FSP-211. Sensor color white unless specified otherwise via PDR. To field-configure, order FSIR-100 accessory separately.
 - Utilizes the Wattstopper sensor FSP-3XX series. Sensor color determined by product finish. See Sensor Color Reference Table. Field-configures via mobile application. See Controls section for details.
 - Sensor passive infrared (PIR) may be overly sensitive when operating below -20°C (-4°F).
 - For the device to be field-configurable, requires WAC Gateway components WAC-PoE and WPOE-120 in appropriate quantities. Only compatible with WaveLinx system and software and requires system components to be installed for operation. See website for more WaveLinx application information.
 - Replace XX with sensor color (WH, BZ, or BK).
 - Only available in PRV-XL configurations C75, C100, C125, C150, or C175.
 - Not available with 347V, 480V, DV, or HA options. Consult LumenSafe system product pages for additional details and compatibility information.
 - Replace XX with paint color.
 - For BAA or TAA requirements, Accessories sold separately will be separately analyzed under domestic preference requirements. Consult factory for further information.
 - Not for use with PRV-XL or PRV-M configurations.
 - Only for use with PRV. Not applicable to PRV-M, PRV-XL, or PRV-P.
 - Must order one per optic/LED when ordering as a field-installable accessory (1, 2, 4, 6 or 9).
 - This tool enables adjustment to Motion Sensor (MS) parameters including high and low modes, sensitivity, time delay, cutoff and more. Consult your lighting representative for more information.
 - Requires 4-PIN twistlock receptacle (ZD or ZW) option.
 - Requires 7-PIN NEMA twistlock photocontrol receptacle (PR & PER7) option. The WOLC-7 cannot be used in conjunction with other controls systems (MS, ZD, ZW or LWR). Operates on 120-347V input voltages.
 - Only for use with PRV-M configurations.
 - Only for use with PRV-XL configurations.
 - Fixed for PRV-M.

LumenSafe Integrated Network Security Camera Technology Options (Add as Suffix)

Product Family	Camera Type	Data Backhaul		
L=LumenSafe Technology 	H=Dome Camera, High Res Z=Dome Camera, Remote PTZ	C=Cellular, Customer Installed SIM Card A=Cellular, Factory Installed AT&T SIM Card	V=Cellular, Factory Installed Verizon SIM Card S=Cellular, Factory Installed Sprint SIM Card	E=Ethernet Networking

Stock Ordering Information

Product Family ¹	Light Engine	Voltage	Distribution
PRVS=Prevail	C15=(1 LED) 7,100 Nominal Lumens C25=(2 LEDs) 13,100 Nominal Lumens C40=(2 LEDs) 17,100 Nominal Lumens C60=(2 LEDs) 20,000 Nominal Lumens	UNV=Universal (120-277V) 347=347V ²	T3=Type III T4=Type IV
PRVS-XL=Prevail XL	C75=(4 LED) 26,100 Nominal Lumens C100=(4 LED) 31,000 Nominal Lumens C125=(4 LED) 36,000 Nominal Lumens C150=(6 LED) 41,100 Nominal Lumens C175=(6 LED) 48,600 Nominal Lumens		

- NOTES:**
- All stock configurations are standard 4000K/70CRI, bronze finish, and include the standard versatile mounting arm.
 - Only available in PRVS configurations C15, C25, C40 or C60.

Mounting Details

SA=QM Pole Mount Arm (PRV & PRV-P)

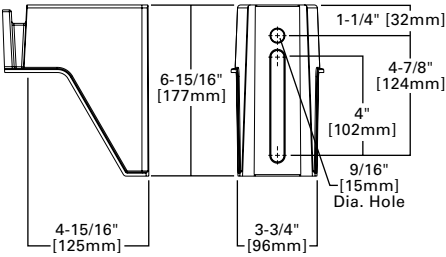

SA=QM Pole Mount Arm (PRV-XL)

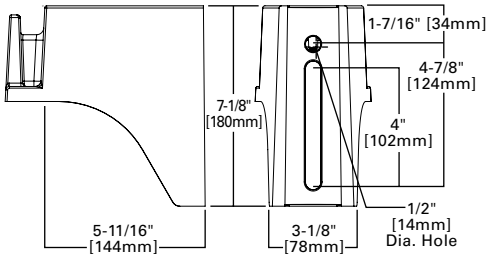

WM=QM Wall Mount Arm (PRV & PRV-P)

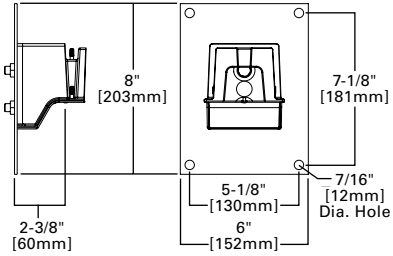

WM=QM Wall Mount Arm (PRV-XL)

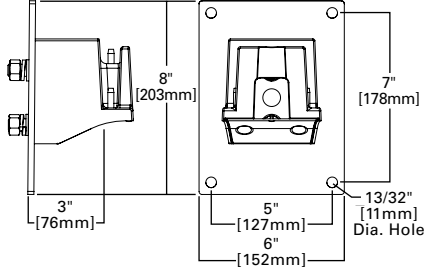

MA=QM Mast Arm (PRV & PRV-P)

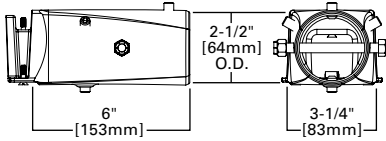

MA=QM Mast Arm (PRV-XL)

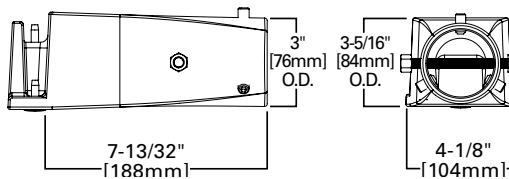

ADJA=Adjustable Arm Pole Mount (PRV & PRV-P)

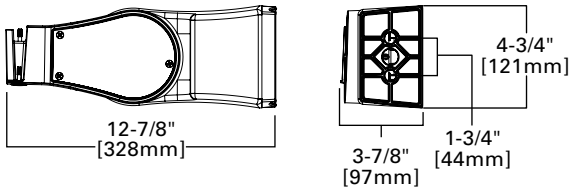

ADJA=Adjustable Arm Pole Mount (PRV-XL)

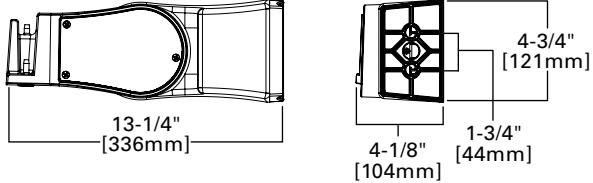

ADJA-WM=Adjustable Arm Wall Mount (PRV & PRV-P)

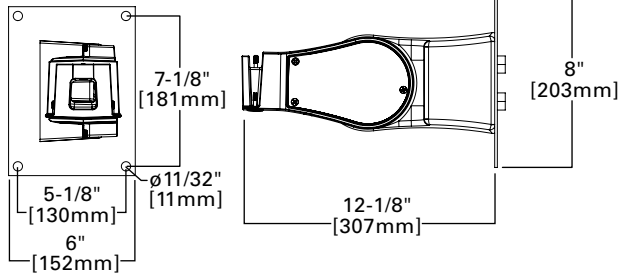

ADJA-WM=Adjustable Arm Wall Mount (PRV-XL)

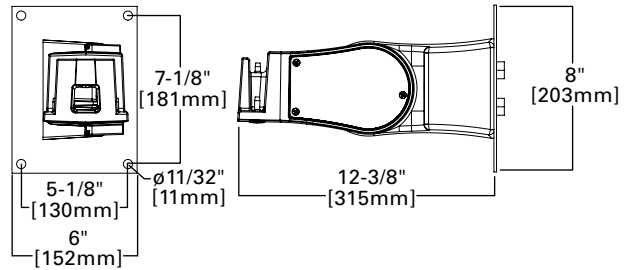

ADJS=Adjustable Slipfitter 3 (PRV & PRV-P)

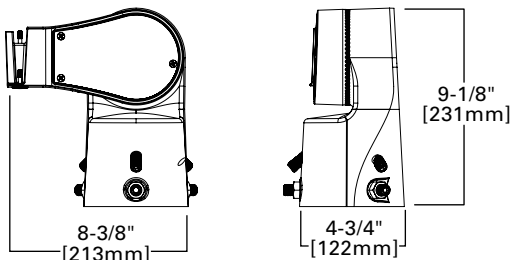

ADJS=Adjustable Slipfitter 3 (PRV-XL)

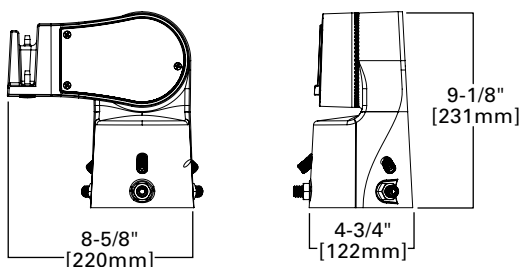

Mounting Details

SA=QM Pole Mount Arm (PRV-M)

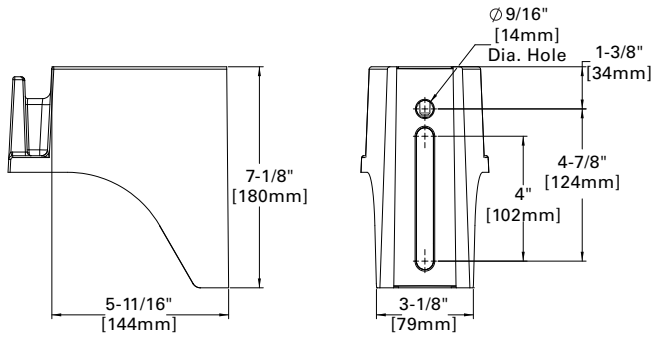

WM=QM Wall Mount Arm (PRV-M)

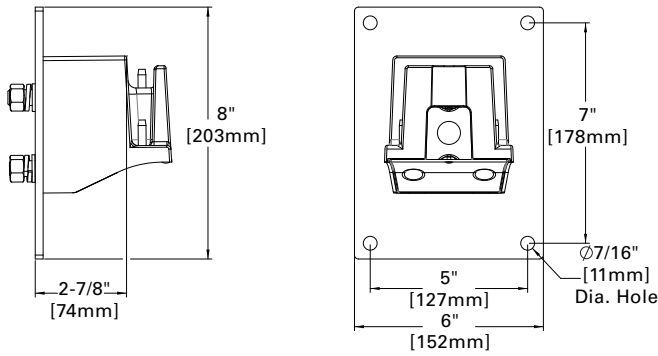

MA=QM Mast Arm (PRV-M)

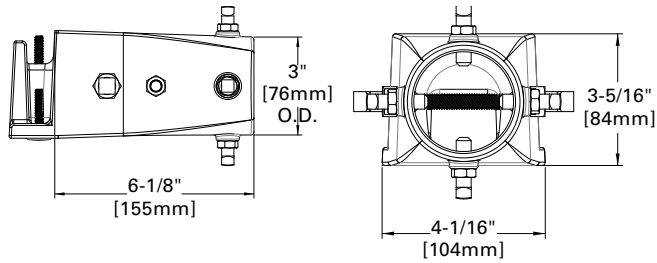

FMA=Fixed Mast Arm (PRV-M)

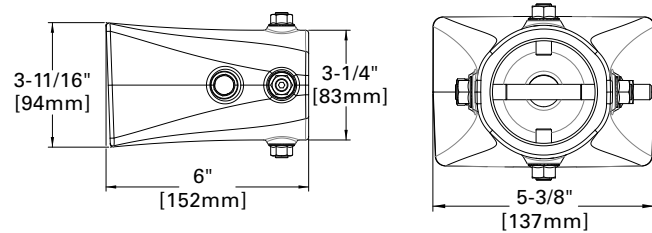

DM=Direct Pole Mount Arm (PRV-M)

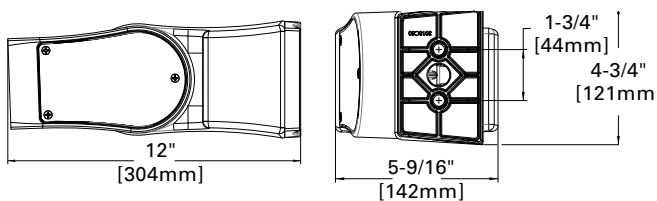

Versatile Mount System

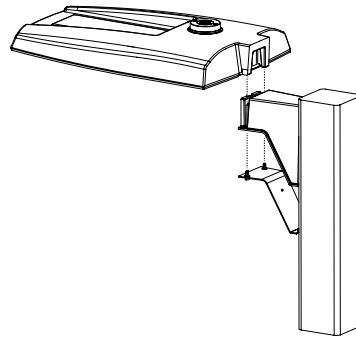

ADJS=Adjustable Slipfitter (PRV-M)

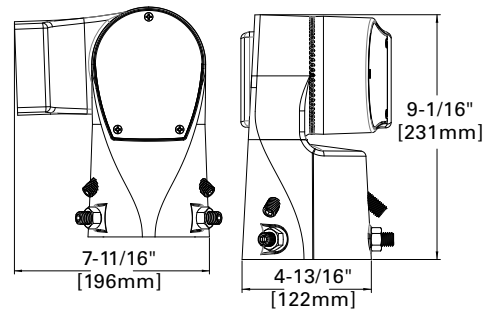

SP2=Adjustable Slipfitter 2-3/8\" (PRV-M)

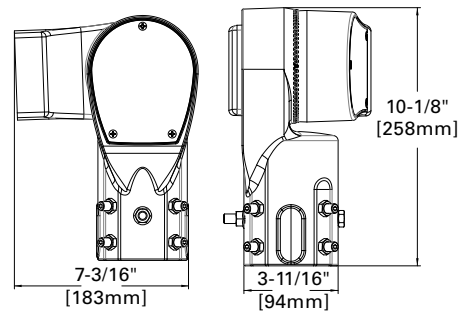

Mounting Details

Mounting Configurations and EPAs

NOTE: For 2 PRV's mounted at 90°, requires minimum 3" square or 4" round pole for fixture clearance. For 2 PRV-XL's mounted at 90°, requires minimum 4" square or round pole for fixture clearance. Customer is responsible for engineering analysis to confirm pole and fixture compatibility for applications.

Housing Size	Tilt Angle (Degrees)	Arm Mount Single	Arm Mount 2 @ 180°	Arm Mount 2 @ 90°	Arm Mount 3 @ 90°	Arm Mount 4 @ 90°
Prevail Petite	0°	0.54	1.08	0.84	1.38	1.38
	60°	1.68	1.85	2.42	3.15	3.30
Prevail	0°	0.92	1.35	1.42	1.63	1.63
	60°	2.20	2.40	3.05	3.88	4.07
	60° + Full Drop Visor	2.20	2.40	3.25	4.28	4.47
Prevail XL	0°	1.12	2.25	2.13	2.52	2.52
	60°	3.99	4.30	5.26	6.51	6.79
	60° + Full Drop Visor	3.99	4.30	5.59	7.17	7.49
Prevail Maxx	0°	1.28	2.56	1.7	2.69	2.69
	60°	5.09	5.52	6.34	7.49	7.81

Optical Configurations

PRV-P-C10/C15/C20/C25
(4,900/6,900/9,800/11,800 Nominal Lumens)



PRV-C15
(7,100 Nominal Lumens)

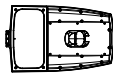

PRV-C25/C40/C60
(13,100/17,100/20,000 Nominal Lumens)

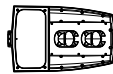

PRV-XL-C75/C100/C125
(26,100/31,000/36,300 Nominal Lumens)

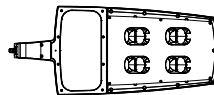

PRV-XL-C150/C175
(41,100/48,600 Nominal Lumens)

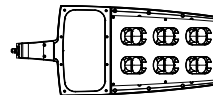

PRV-M-PA6X
(50,000/60,000/70,000/80,000 Nominal Lumens)

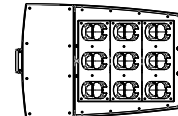

Optical Distributions

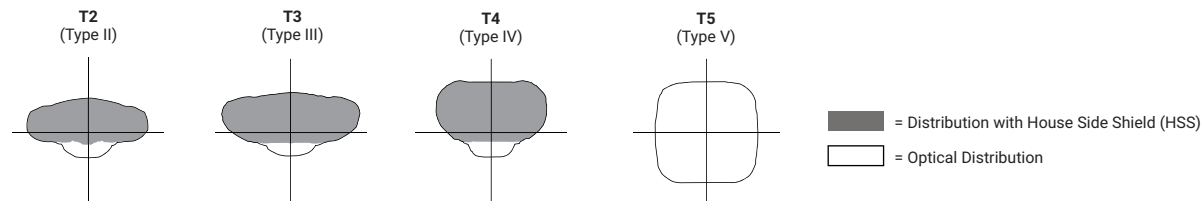

Product Specifications

Construction

- Single-piece die-cast aluminum housing
- Tethered die-cast aluminum door

Optics

- Dark Sky Approved (3000K CCT and warmer only)
- Precision molded polycarbonate optics

Electrical

- -40°C minimum operating temperature
- 40°C maximum operating temperature
- >.9 power factor
- <20% total harmonic distortion
- Class 1 electronic drivers have expected life of 100,000 hours with <1% failure rate
- 0-10V dimming driver is standard with leads external to the fixture
- Standard MOV surge protective device designed to withstand 10kV of transient line surge

Mounting

- Versatile, patented, standard mount arm accommodates multiple drill patterns ranging from 1-1/2" to 4-7/8" (Type M drilling recommended for new installations)
- A knock-out on the standard mounting arm enables round pole mounting
- Adjustable pole and wall mount arms adjust in 5° increments from 0° to 60°; Downward facing orientation only (Type N drilling required for ADJA mount)
- Adjustable slipfitter arm adjusts in 5° increments from -5° to 85°; Downward facing orientation only
- Adjustable Arms: 1.5G vibration rated
- Prevail and Prevail Petite: 3G vibration rated
- Prevail XL Mast Arm: 3G vibration rated
- Prevail XL Standard Arm: 1.5G vibration rated

Typical Applications

- Parking lots, Walkways, Roadways and Building Areas

Finish

- Five-stage super TGIC polyester powder coat paint, 2.5 mil nominal thickness
- Finish is compliant to 3,000 hour salt spray standard (per ASTM B117)

Shipping Data

- Prevail Petite: 18 lbs. (7.94 kgs.)
- Prevail: 20 lbs. (9.09 kgs.)
- Prevail XL: 45 lbs. (20.41 kgs.)
- Prevail Maxx: 49 lbs. (22.23 kgs.)

Warranty

- Five year limited warranty, consult website for details. www.cooperlighting.com/legal

Energy and Performance Data

[View PRV-P IES files](#)

[View PRV IES files](#)

[View PRV-XL IES files](#)

Power and Lumens

Product Family	Prevail Petite				Prevail				Prevail XL					Prevail Maxx				
Light Engine	C10	C15	C20	C25	C15	C25	C40	C60	C75	C100	C125	C150	C175	C200	C225	C250	C275	
Power (Watts)	35	49	73	94	52	96	131	153	176	217	264	285	346	346	418	487	588	
Input Current @ 120V (A)	0.29	0.41	0.61	0.79	0.43	0.80	1.09	1.32	1.50	1.84	2.21	2.38	2.92	2.89	3.49	4.06	4.90	
Input Current @ 277V (A)	0.13	0.18	0.27	0.35	0.19	0.35	0.48	0.57	0.66	0.82	0.97	1.04	1.25	1.26	1.51	1.72	2.06	
Input Current @ 347V (A)	0.11	0.16	0.23	0.29	0.17	0.30	0.41	0.48	0.54	0.66	0.79	0.84	1.02	1.00	1.21	1.40	1.70	
Input Current @ 480V (A)	0.08	0.12	0.17	0.22	0.12	0.22	0.30	0.35	0.40	0.48	0.57	0.62	0.74	0.73	0.88	1.00	1.21	
Distribution ¹																		
Type II	4000K Lumens	4,775	6,717	9,542	11,521	7,123	13,205	17,172	20,083	26,263	31,231	36,503	41,349	48,876	50,349	59,444	68,447	79,322
	BUG Rating	B1-U0-G1	B1-U0-G1	B2-U0-G2	B2-U0-G2	B2-U0-G2	B2-U0-G2	B3-U0-G3	B3-U0-G3	B3-U0-G3	B3-U0-G4	B4-U0-G4	B4-U0-G4	B4-U0-G5	B4-U0-G5	B4-U0-G5	B4-U0-G5	B5-U0-G5
	Lumens per Watt	138	137	131	122	137	138	131	131	149	144	138	145	141	146	142	141	135
	3000K Lumens ¹	4,869	6,595	9,369	11,312	6,994	12,965	16,860	19,718	25,786	30,664	35,840	40,598	47,989	49,437	58,368	67,208	77,886
Type III	4000K Lumens	4,782	6,727	9,556	11,538	7,111	13,183	17,144	20,050	26,120	31,061	36,304	41,124	48,610	50,162	59,223	68,193	79,027
	BUG Rating	B1-U0-G2	B1-U0-G2	B2-U0-G3	B2-U0-G3	B1-U0-G2	B2-U0-G3	B3-U0-G4	B3-U0-G4	B3-U0-G5	B3-U0-G5	B3-U0-G5	B4-U0-G5	B4-U0-G5	B4-U0-G5	B4-U0-G5	B5-U0-G5	B5-U0-G5
	Lumens per Watt	138	137	131	123	137	137	131	131	148	143	138	144	140	145	142	140	135
	3000K Lumens ¹	4,695	6,605	9,383	11,329	6,982	12,944	16,832	19,686	25,646	30,497	35,645	40,377	47,727	49,254	58,151	66,958	77,596
Type IV	4000K Lumens	4,880	6,865	9,752	11,774	7,088	13,140	17,087	19,984	26,098	31,035	36,274	41,089	48,569	50,575	59,711	68,754	79,678
	BUG Rating	B1-U0-G2	B1-U0-G2	B2-U0-G3	B2-U0-G3	B1-U0-G3	B2-U0-G4	B2-U0-G4	B3-U0-G5	B3-U0-G5	B3-U0-G5	B3-U0-G5	B3-U0-G5	B4-U0-G5	B4-U0-G5	B4-U0-G5	B4-U0-G5	B5-U0-G5
	Lumens per Watt	141	140	134	125	136	137	130	131	148	143	137	144	140	146	143	141	136
	3000K Lumens ¹	4,792	6,740	9,575	11,561	6,959	12,901	16,777	19,621	25,624	30,471	35,615	40,343	47,687	49,659	58,630	67,510	78,235
Type V	4000K Lumens	5,067	7,128	10,126	12,226	7,576	14,045	18,264	21,360	28,129	33,450	39,097	44,287	52,349	53,531	63,201	72,773	84,335
	BUG Rating	B3-U0-G2	B3-U0-G2	B4-U0-G3	B4-U0-G3	B3-U0-G3	B4-U0-G3	B4-U0-G4	B5-U0-G4	B5-U0-G5	B5-U0-G5	B5-U0-G5	B5-U0-G5	B5-U0-G5	B5-U0-G5	B5-U0-G5	B5-U0-G5	B5-U0-G5
	Lumens per Watt	146	145	139	130	146	146	139	140	160	154	148	155	151	155	151	150	144
	3000K Lumens ¹	4,975	6,999	9,942	12,004	7,438	13,790	17,932	20,972	27,618	32,843	38,387	43,483	51,398	52,562	62,057	71,455	82,808

NOTES:
1. For 3000K, 5000K or HSS data, refer to published IES files.

Lumen Maintenance

Configuration	TM-21 Lumen Maintenance (50,000 Hours)	Theoretical L70 (Hours)
Prevail and Prevail Petite at 25°C	91.30%	> 194,000
Prevail and Prevail Petite at 40°C	87.59%	> 134,000
Prevail XL at 25°C	91.40%	> 204,000
Prevail XL at 40°C	89.41%	> 158,000
Prevail Maxx at 25°C	91.40%	> 204,000
Prevail Maxx at 40°C	89.41%	> 158,000

Sensor Color Reference Table (SPBx)

Housing Finish	Sensor Color
AP =Grey	Grey
BZ =Bronze	Bronze
BK =Black	Black
DP =Dark Platinum	Grey
GM =Graphite Metallic	Black
WH =White	White

Lumen Multiplier

Ambient Temperature	Lumen Multiplier
10°C	1.02
15°C	1.01
25°C	1.00
40°C	0.99

Control Options

0-10V This fixture provides 0-10V dimming wire leads for use with a lighting control panel or other control method.

Photocontrol (PR and PR7) Photocontrol receptacles provide a flexible solution to enable “dusk-to-dawn” lighting by sensing light levels. Advanced control systems compatible with NEMA 7-PIN standards can be utilized with the PR7 receptacles.

Dimming Occupancy Sensor (SPB, MS/DIM-LXX) These sensors are factory installed in the luminaire housing. When the SPB or MS/DIM sensor options are selected, the luminaire will dim down after five minutes of no activity detected. When activity is detected, the luminaire returns to full light output. These occupancy sensors include an integral photocell for “dusk-to-dawn” control or “daylight harvesting.” Factory default is enabled for the MS sensors and disabled for the SPB. SPB motion sensors require the Sensor Configuration mobile application by Wattstopper to change factory default dimming level, time delay, sensitivity and other parameters. Available for iOS and Android devices. The SPB sensor is factory preset to dim down to approximately 10% power with a time delay of five minutes.

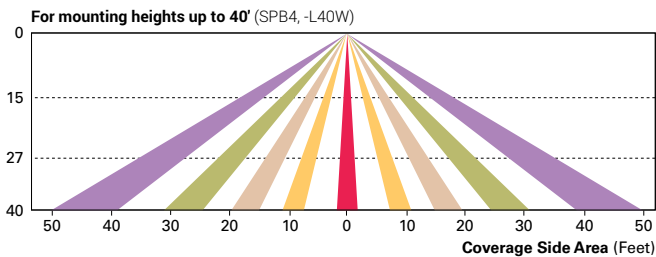
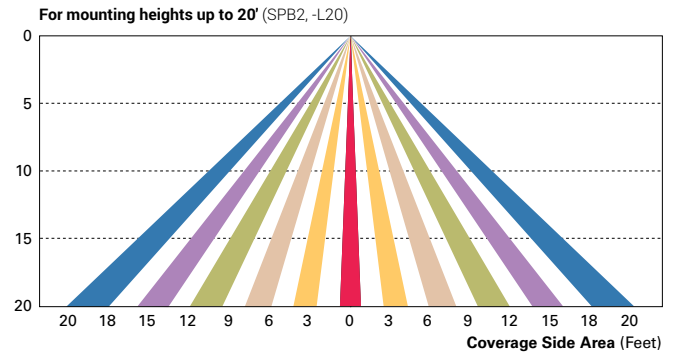
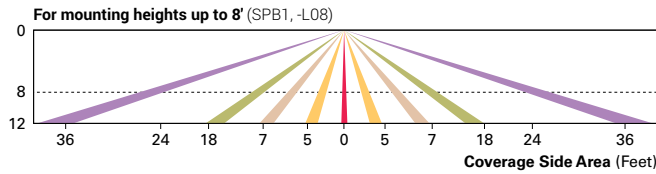

WaveLinx Wireless Control and Monitoring System Available in 7-PIN or 4-PIN configurations, the WaveLinx Outdoor control platform operates on a wireless mesh network based on IEEE 802.15.4 standards enabling wireless control of outdoor lighting. At least one Wireless Area Controller (WAC) is required for full functionality and remote communication (including adjustment of any factory pre-sets).

WaveLinx Outdoor Control Module (WOLC-7P-10A) A photocontrol that enables astronomical or time-based schedules to provide ON, OFF and dimming control of fixtures utilizing a 7-PIN receptacle. The out-of-box functionality is ON at dusk and OFF at dawn.

WaveLinx Wireless Sensor (SWPD4 and SWPD5) These outdoor sensors offer passive infrared (PIR) occupancy sensing and a photocell for closed-loop daylight sensing. These sensors can be factory installed or field-installed via simple, tool-less integration into luminaires equipped with the Zhaga Book 18 compliant 4-PIN receptacle (ZD or ZW). These sensors are factory preset to dim down to approximately 50 percent power after 15 minutes of no activity detected, and the photocell for “dusk-to-dawn” control is default enabled. A variety of sensor lenses are available to optimize the coverage pattern for mounting heights from 7'-40'.

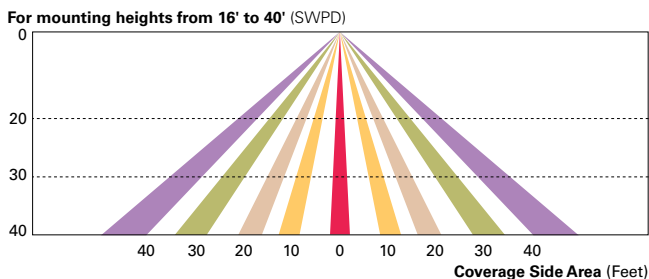

LumenSafe (LD) The LumenSafe integrated network camera is a streamlined, outdoor-ready camera that provides high definition video surveillance. This IP camera solution is optimally designed to integrate into virtually any video management system or security software platform of choice. No additional wiring is needed beyond providing line power to the luminaire. LumenSafe features factory-installed power and networking gear in a variety of networking options allowing security integrators to design the optimal solution for active surveillance.