

Project		Catalog #		Type	
Prepared by		Notes		Date	



Lumark

PRV / PRV-XL Prevail LED

Area / Site Luminaire

Typical Applications

Outdoor • Parking Lots • Walkways • Roadways • Building Areas

Interactive Menu

- Ordering Information [page 2](#)
- Mounting Details [page 3](#)
- Optical Configurations [page 3](#)
- Product Specifications [page 3](#)
- Energy and Performance Data [page 4](#)
- Control Options [page 5](#)

Product Certifications



Product Features



Quick Facts

- Lumen packages range from 7,100 - 48,600 lumens (50W - 350W)
- Replaces 70W up to 1,000W HID equivalents
- Efficacies up to 148 lumens per watt
- Energy and maintenance savings up to 85% versus HID solutions
- Standard universal quick mount arm with universal drill pattern

Dimensional Details

Prevail

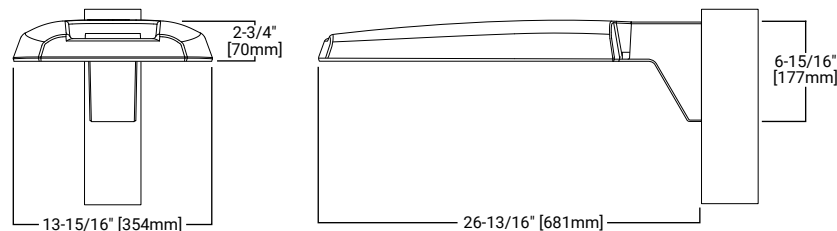

Prevail XL

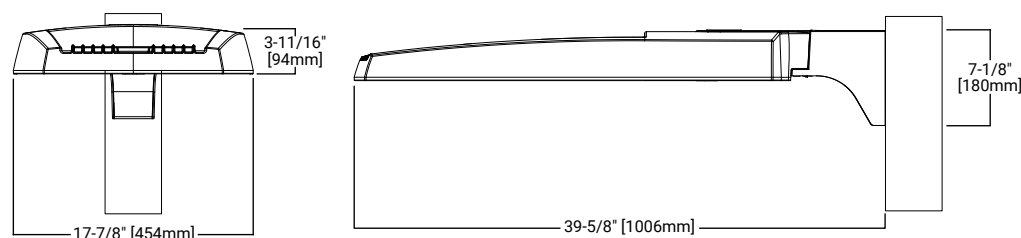

Ordering Information

SAMPLE NUMBER: PRV-XL-C75-D-UNV-T4-SA-BZ

Product Family ^{1,2}	Light Engine ³	Driver	Voltage	Distribution	Mounting (Included)	Color
PRV=Prevail	C15=(1 LED) 7,100 Nominal Lumens C25=(2 LEDs) 13,100 Nominal Lumens C40=(2 LEDs) 17,100 Nominal Lumens C60=(2 LEDs) 20,000 Nominal Lumens	D=Dimming (0-10V)	UNV=Universal (120-277V) 347=347V 480=480V ⁴	T2=Type II T3=Type III T4=Type IV T5=Type V	SA=Standard Versatile Arm MA=Mast Arm WM=Wall Mount Arm	AP=Grey BZ=Bronze BK=Black DP=Dark Platinum GM=Graphite Metallic WH=White
PRV-XL=Prevail XL	C75=(4 LED) 26,100 Nominal Lumens C100=(4 LED) 31,000 Nominal Lumens C125=(4 LED) 36,000 Nominal Lumens C150=(6 LED) 41,100 Nominal Lumens C175=(6 LED) 48,600 Nominal Lumens					

Options (Add as Suffix)	Accessories (Order Separately) ¹⁷
<p>7030=70 CRI / 3000K CCT ⁵ 7050=70 CRI / 5000K CCT ⁵ HSS=House Side Shield ⁶ L90=Optics Rotated 90° Left R90=Optics Rotated 90° Right 10K=10kV/10kA UL 1449 Fused Surge Protective Device HA=50°C High Ambient Temperature ⁷ PER=NEMA 3-PIN Twistlock Photocontrol Receptacle PER7=NEMA 7-PIN Twistlock Photocontrol Receptacle MSP/DIM-L12=Integrated Sensor for Dimming Operation, 8' - 12' Mounting Height ^{8,9} MSP/DIM-L30=Integrated Sensor for Dimming Operation, 12' - 30' Mounting Height ^{8,9} MSP-L12=Integrated Sensor ON/OFF Operation, 8' - 12' Mounting Height ^{8,9} MSP-L30=Integrated Sensor ON/OFF Dimming Operation, 12' - 30' Mounting Height ^{8,9} MS/DIM-L20=Motion Sensor for Dimming Operation, 9' - 20' Mounting Height ^{9,10} MS/DIM-L40W=Motion Sensor for Dimming Operation, 21' - 40' Mounting Height ^{9,10} MS-L20=Motion Sensor for ON/OFF Operation, 9' - 20' Mounting Height ^{9,10} MS-L40W=Motion Sensor for ON/OFF Operation, 21' - 40' Mounting Height ^{9,10} ZW=Wavelinx-enabled 4-PIN Twistlock Receptacle ^{9,11,12} ZW-SWPD4XX=Wavelinx Wireless Sensor, 7' - 15' Mounting Height ^{9,11,12,13} ZW-SWPD5XX=Wavelinx Wireless Sensor, 15' - 40' Mounting Height ^{9,11,12,13} LWR-LW=LumaWatt Pro Wireless Sensor, Wide Lens for 8' - 16' Mounting Height ^{9,14} LWR-LN=LumaWatt Pro Wireless Sensor, Narrow Lens for 16' - 40' Mounting Height ^{9,14} (See Table Below)=LumenSafe Integrated Network Security Camera ^{15,16}</p>	<p>PRVWM-XX=Wall Mount Kit ⁸ PRVMA-XX=Mast Arm Mounting Kit ⁸ PRVSA-XX=Standard Arm Mounting Kit ⁸ PRVXLSA-XX=Standard Arm Mounting Kit (for Prevail XL) ¹⁵ PRVXLWM-XX=Wall Mount Kit (for Prevail XL) ¹⁵ PRVXLMA-XX=Mast Arm Mounting Kit (for Prevail XL) ¹⁵ MA1010-XX=Single Tenon Adapter for 3-1/2" O.D. Tenon MA1011-XX=2@180° Tenon Adapter for 3-1/2" O.D. Tenon MA1017-XX=Single Tenon Adapter for 2-3/8" O.D. Tenon MA1018-XX=2@180° Tenon Adapter for 2-3/8" O.D. Tenon HS/VERD=House Side Shield ^{6,18} VGS-F/B=Vertical Glare Shield, Front/Back ¹⁸ VGS-SIDE=Vertical Glare Shield, Side ¹⁸ OA/RA1013=Photocontrol Shorting Cap OA/RA1014=NEMA Photocontrol - 120V OA/RA1016=NEMA Photocontrol - Multi-Tap 105-285V OA/RA1201=NEMA Photocontrol - 347V OA/RA1027=NEMA Photocontrol - 480V ISHH-01=Integrated Sensor Programming Remote ¹⁹ FSIR-100=Wireless Configuration Tool for Occupancy Sensor ²⁰ SWPD4-XX=Wavelinx Wireless Sensor, 7' - 15' Mounting Height ^{12,13,21} SWPD5-XX=Wavelinx Wireless Sensor, 15' - 40' Mounting Height ^{12,13,21} WOLC-7P-10A=Wavelinx Outdoor Control Module (7-PIN) ²²</p>

NOTES:

- DesignLights Consortium® Qualified. Refer to www.designlights.org Qualified Products List under Family Models for details.
- Customer is responsible for engineering analysis to confirm pole and fixture compatibility for applications. Refer to installation instructions and pole white paper WP513001EN for additional support information.
- Standard 4000K CCT and 70CRI.
- Only for use with 480V Wye systems. Per NEC, not for use with ungrounded systems, impedance grounded systems or corner grounded systems (commonly known as Three Phase Three Wire Delta, Three Phase High Leg Delta and Three Phase Corner Grounded Delta systems).
- Use dedicated IES files on product website for non-standard CCTs.
- Option will come factory-installed. House Side Shield not suitable with T5 distribution or C60 lumen package.
- Not available with C60 lumen package.
- Only available in PRV configurations C15, C25, C40 or C60.
- Controls system is not available with photocontrol receptacle (PER or PER7) or other controls systems (MS, MSP, ZW or LWR).
- Utilizes the Wattstopper sensor FSP-211.
- Sensor passive infrared (PIR) may be overly sensitive when operating below -20°C (-4°F).
- In order for the device to be field-configurable, requires WAC Gateway components WAC-PoE and WPOE-120 in appropriate quantities. Only compatible with WaveLinx system and software and requires system components to be installed for operation. See website for more Wavelinx application information.
- Replace XX with sensor color (WH, BZ, or BK).
- LumaWatt Pro wireless sensors are factory installed and require network components LWP-EM-1, LWP-GW-1, and LWP-PoE8 in appropriate quantities. See website for LumaWatt Pro application information.
- Only available in PRV-XL configurations C75, C100, C125, C150, or C175.
- Not available with 347V, 480V, or HA options. Consult LumenSafe system product pages for additional details and compatibility information.
- Replace XX with paint color.
- Must order one per optic/LED when ordering as a field-installable accessory (1, 2, 4, or 6).
- This tool enables adjustment to Integrated Sensor (MSP) parameters including high and low modes, sensitivity, time delay, cutoff and more. Consult your lighting representative at Eaton for more information.
- This tool enables adjustment to Motion Sensor (MS) parameters including high and low modes, sensitivity, time delay, cutoff and more. Consult your lighting representative at Eaton for more information.
- Requires Wavelinx-enabled 4-PIN twistlock receptacle (ZW) option.
- Requires 7-PIN NEMA twistlock photocontrol receptacle (PER7) option. The WOLC-7 cannot be used in conjunction with other controls systems (MS, MSP, ZW or LWR).

LumenSafe Integrated Network Security Camera Technology Options (Add as Suffix)

Product Family	Camera Type	Data Backhaul
L=LumenSafe Technology 	D=Dome Camera	C=Cellular, Customer Installed SIM Card A=Cellular, Factory Installed AT&T SIM Card V=Cellular, Factory Installed Verizon SIM Card S=Cellular, Factory Installed Sprint SIM Card E=Ethernet Networking

Stock Ordering Information

Product Family ¹	Light Engine	Voltage	Distribution	Options (Add as Suffix)
PRVS=Prevail	C15=(1 LED) 7,100 Nominal Lumens C25=(2 LEDs) 13,100 Nominal Lumens C40=(2 LEDs) 17,100 Nominal Lumens C60=(2 LEDs) 20,000 Nominal Lumens	UNV=Universal (120-277V) 347=347V ²	T3=Type III T4=Type IV	MSP/DIM-L30=Integrated Sensor for Dimming Operation, Maximum 30' Mounting Height ²
PRVS-XL=Prevail XL	C75=(4 LED) 26,100 Nominal Lumens C100=(4 LED) 31,000 Nominal Lumens C125=(4 LED) 36,000 Nominal Lumens C150=(6 LED) 41,100 Nominal Lumens C175=(6 LED) 48,600 Nominal Lumens			

NOTES:

- All stock configurations are standard 4000K/70CRI, bronze finish, and include the standard versatile mounting arm.
- Only available in PRVS configurations C15, C25, C40 or C60.

Mounting Details

Pole Mount Arm (PRV)

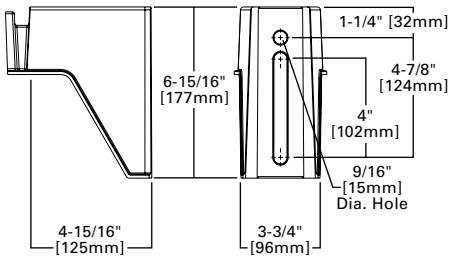

Pole Mount Arm (PRV-XL)

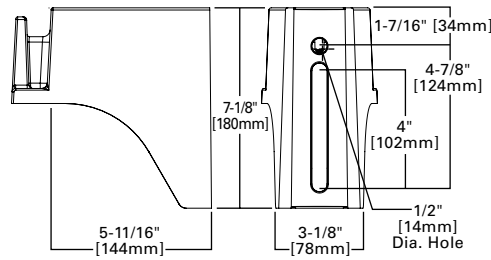

Versatile Mount System

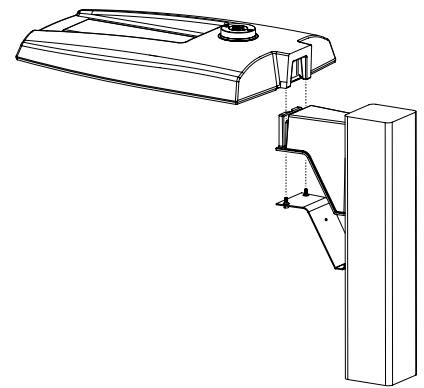

Wall Mount (PRV)

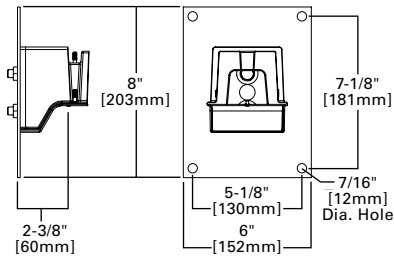

Wall Mount (PRV-XL)

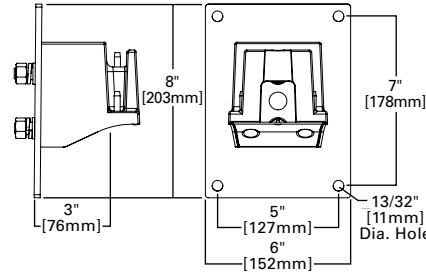

Mast Arm Mount (PRV)

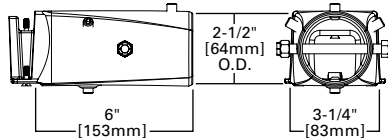

Mast Arm Mount (PRV-XL)

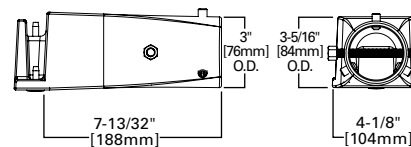

Mounting Configurations and EPAs

NOTE: For 2 PRV's mounted at 90°, requires minimum 3" square or 4" round pole for fixture clearance. For 2 PRV-XL's mounted at 90°, requires minimum 4" square or round pole for fixture clearance. Customer is responsible for engineering analysis to confirm pole and fixture compatibility for applications.

Wall Mount	Arm Mount Single EPA 0.92 (PRV) EPA 1.12 (PRV-XL)	Arm Mount 2 @ 180° EPA 1.35 (PRV) EPA 2.25 (PRV-XL)	Arm Mount 2 @ 90° EPA 1.42 (PRV) EPA 2.13 (PRV-XL)	Arm Mount 3 @ 90° EPA 1.63 (PRV) EPA 2.52 (PRV-XL)	Arm Mount 4 @ 90° EPA 1.63 (PRV) EPA 2.52 (PRV-XL)
-------------------	--	--	---	---	---

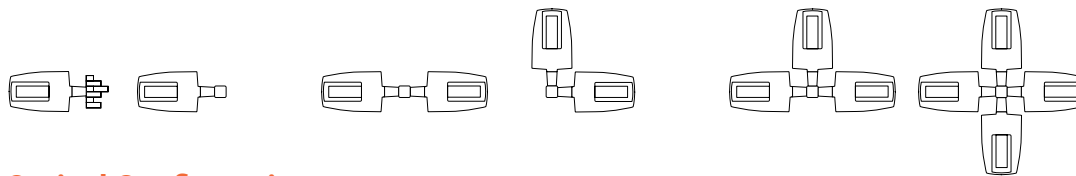

Optical Configurations

PRV-C15 (7,100 Nominal Lumens)	PRV-C25/C40/C60 (13,100/17,100/20,000 Nominal Lumens)	PRV-XL-C75/C100/C125 (26,100/31,000/36,300 Nominal Lumens)	PRV-XL-C150/C175 (41,100/48,600 Nominal Lumens)
--	---	--	---

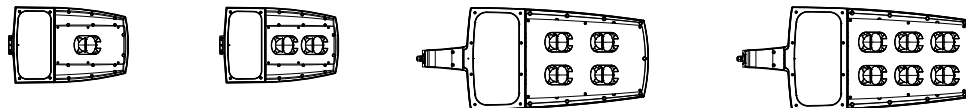

Product Specifications

Construction

- Single-piece die-cast aluminum housing
- Tethered die-cast aluminum door

Optics

- Dark Sky Approved (3000K CCT and warmer only)
- Precision molded polycarbonate optics

Electrical

- -40°C minimum operating temperature
- 40°C maximum operating temperature
- >.9 power factor
- <20% total harmonic distortion

- Class 1 electronic drivers have expected life of 100,000 hours with <1% failure rate
- 0-10V dimming driver is standard with leads external to the fixture

Mounting

- Versatile, patented, standard mount arm accommodates multiple drill patterns ranging from 1-1/2" to 4-7/8"
- A knock-out on the standard mounting arm enables round pole mounting
- Prevail: 3G vibration rated
- Prevail XL Mast Arm: 3G vibration rated
- Prevail XL Standard Arm: 1.5G vibration rated

Finish

- Five-stage super TGIC polyester powder coat paint, 2.5 mil nominal thickness

Shipping Data

- Prevail: 20 lbs. (9.09 kgs.)
- Prevail XL: 45 lbs. (20.41 kgs.)

Energy and Performance Data

Power and Lumens (PRV)

 [View PRV IES files](#)

Light Engine	C15	C25	C40	C60	
Power (Watts)	52	96	131	153	
Input Current @ 120V (A)	0.43	0.80	1.09	1.32	
Input Current @ 277V (A)	0.19	0.35	0.48	0.57	
Input Current @ 347V (A)	0.17	0.30	0.41	0.48	
Input Current @ 480V (A)	0.12	0.22	0.30	0.35	
Distribution					
Type II	4000K Lumens	7,123	13,205	17,172	20,083
	BUG Rating	B2-U0-G2	B2-U0-G2	B3-U0-G3	B3-U0-G3
	3000K Lumens	6,994	12,965	16,860	19,718
Type III	4000K Lumens	7,111	13,183	17,144	20,050
	BUG Rating	B1-U0-G2	B2-U0-G3	B3-U0-G4	B3-U0-G4
	3000K Lumens	6,982	12,944	16,832	19,686
Type IV	4000K Lumens	7,088	13,140	17,087	19,984
	BUG Rating	B1-U0-G3	B2-U0-G4	B2-U0-G4	B3-U0-G5
	3000K Lumens	6,959	12,901	16,777	19,621
Type V	4000K Lumens	7,576	14,045	18,264	21,360
	BUG Rating	B3-U0-G3	B4-U0-G3	B4-U0-G4	B5-U0-G4
	3000K Lumens	7,438	13,790	17,932	20,972

Lumen Maintenance

Configuration	TM-21 Lumen Maintenance (50,000 Hours)	Theoretical L70 (Hours)
Up to PRV-C60 at 25°C	91.30%	194,000
Up to PRV-C60 at 40°C	87.59%	134,000
Up to PRV-XL-C175 at 25°C	91.40%	204,000
Up to PRV-XL-C175 at 40°C	89.41%	158,000

Lumen Multiplier

Ambient Temperature	Lumen Multiplier
10°C	1.02
15°C	1.01
25°C	1.00
40°C	0.99

Power and Lumens (PRV-XL)

 [View PRV-XL IES files](#)

Light Engine	C75	C100	C125	C150	C175	
Power (Watts)	176	217	264	285	346	
Input Current @ 120V (A)	1.50	1.84	2.21	2.38	2.92	
Input Current @ 277V (A)	0.66	0.82	0.97	1.04	1.25	
Input Current @ 347V (A)	0.54	0.66	0.79	0.84	1.02	
Input Current @ 480V (A)	0.40	0.48	0.57	0.62	0.74	
Distribution						
Type II	4000K Lumens	26,263	31,231	36,503	41,349	48,876
	BUG Rating	B3-U0-G3	B3-U0-G4	B4-U0-G4	B4-U0-G4	B4-U0-G5
	3000K Lumens	25,786	30,664	35,840	40,598	47,989
Type III	4000K Lumens	26,120	31,061	36,304	41,124	48,610
	BUG Rating	B3-U0-G5	B3-U0-G5	B3-U0-G5	B4-U0-G5	B4-U0-G5
	3000K Lumens	25,646	30,497	35,645	40,377	47,727
Type IV	4000K Lumens	26,098	31,035	36,274	41,089	48,569
	BUG Rating	B3-U0-G5	B3-U0-G5	B3-U0-G5	B3-U0-G5	B4-U0-G5
	3000K Lumens	25,624	30,471	35,615	40,343	47,687
Type V	4000K Lumens	28,129	33,450	39,097	44,287	52,349
	BUG Rating	B5-U0-G5	B5-U0-G5	B5-U0-G5	B5-U0-G5	B5-U0-G5
	3000K Lumens	27,618	32,843	38,387	43,483	51,398

Control Options

0-10V (D) The dimming option provides 0-10V dimming wire leads for use with a lighting control panel or other control method.

Photocontrol (PER and PER7) Photocontrol receptacles provide a flexible solution to enable "dusk-to-dawn" lighting by sensing light levels. Advanced control systems compatible with NEMA 7-pin standards can be utilized with the PER7 receptacle.

Dimming Occupancy Sensor (MSP and MS) These sensors are factory installed in the luminaire housing. When a sensor for dimming operation (/DIM) option is selected, the luminaire will dim down to approximately 50 percent power after five minutes of no activity detected. When activity is detected, the luminaire returns to full light output. When a sensor for ON/OFF operation is selected, the luminaire will turn off after five minutes of no activity.

These occupancy sensors include an integral photocell that can be activated or inactivated with the programming remote / configuration tool for "dusk-to-dawn" control or "daylight harvesting". **Note:** For MSP sensors, the factory preset is ON (Enabled), and for MS sensors, the factory preset is OFF (Disabled). The programming remote / tool is a wireless tool that can be utilized to change the dimming level, time delay, sensitivity and other parameters. A variety of sensor lenses are available to optimize the coverage pattern for mounting heights from 8'-40'.

For mounting heights from 8' to 12' (-L12)

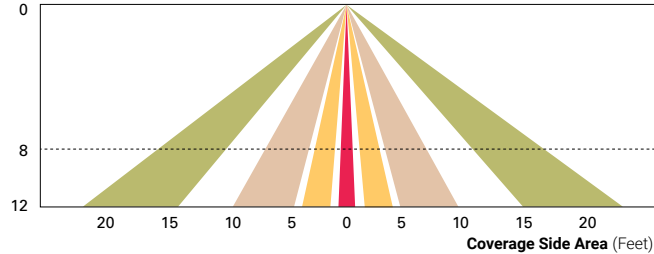

For mounting heights from 12' to 30' (-L30)

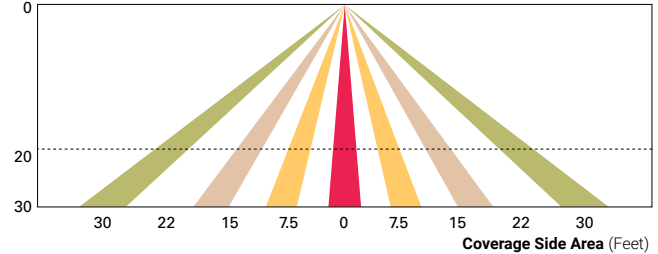

For mounting heights from 9' to 20' (-L20)

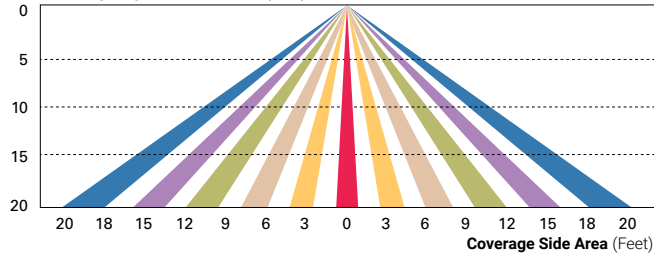

For mounting heights from 21' to 40' (-L40W)

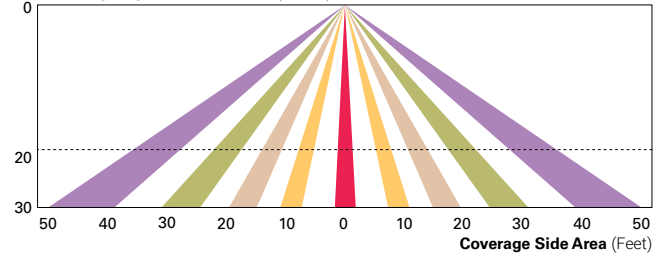

WaveLinx Wireless Control and Monitoring System Available in 7-PIN or 4-PIN configurations, the WaveLinx Outdoor control platform operates on a wireless mesh network based on IEEE 802.15.4 standards enabling wireless control of outdoor lighting. Use the WaveLinx Mobile application for set-up and configuration. At least one Wireless Area Controller (WAC) is required for full functionality and remote communication (including adjustment of any factory pre-sets).

WaveLinx Outdoor Control Module (WOLC-7P-10A) A photocontrol that enables astronomical or time-based schedules to provide ON, OFF and dimming control of fixtures utilizing a 7-PIN receptacle. The out-of-box functionality is ON at dusk and OFF at dawn.

WaveLinx Wireless Sensor (SWPD4 and SWPD5) These outdoor sensors offer passive infrared (PIR) occupancy and a photocell for closed loop daylight sensing. These sensors can be factory installed or field-installed via simple, tool-less integration into luminaires equipped with the Zhaga Book 18 compliant 4-PIN receptacle (ZW). These sensors are factory preset to dim down to approximately 50 percent power after 15 minutes of no activity detected. These occupancy sensors include an integral photocell for "dusk-to-dawn" control or daylight harvesting that is factory-enabled. A variety of sensor lenses are available to optimize the coverage pattern for mounting heights from 7'-40'.

For mounting heights from 16' to 40' (SWPD)

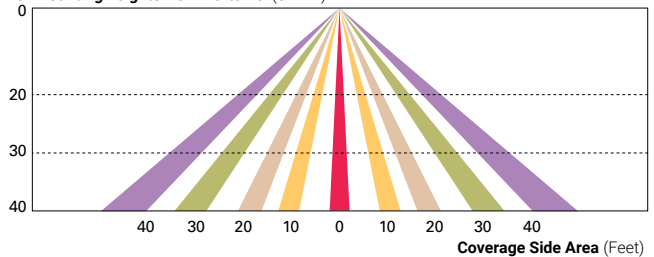

LumaWatt Pro Wireless Control and Monitoring System (LWR-LW and LWR-LN) The Eaton's LumaWatt Pro powered by Enlighted is a connected lighting solution that combines LED luminaires with an integrated wireless sensor system. The sensor controls the lighting system in compliance with the latest energy codes and collects valuable data about building performance and use. Software applications turn the granular data into information through energy dashboards and specialized apps that make it simple and help optimize the use of other resources beyond lighting.

For mounting heights from 8' to 16' (LWR-LW)

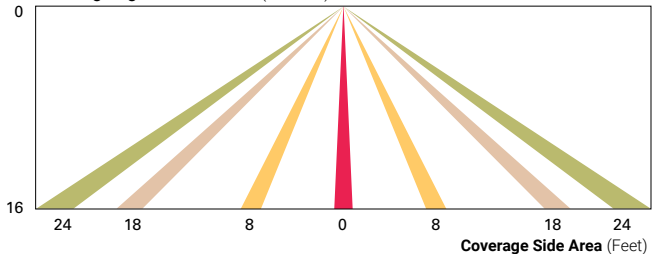

For mounting heights from 16' to 40' (LWR-LN)

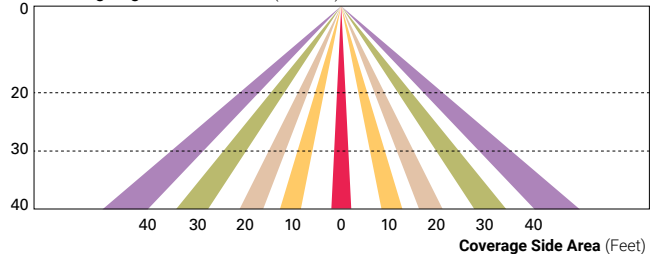

LumenSafe (LD) The LumenSafe integrated network camera is a streamlined, outdoor-ready camera that provides high definition video surveillance. This IP camera solution is optimally designed to integrate into virtually any video management system or security software platform of choice. No additional wiring is needed beyond providing line power to the luminaire. LumenSafe features factory-installed power and networking gear in a variety of networking options allowing security integrators to design the optimal solution for active surveillance.