



D-Series Size 0 LED Area Luminaire

Catalog Number
Notes
Type

Hit the Tab key or mouse over the page to see all interactive elements.



Specifications

EPA:	0.95 ft ² (.09 m ²)
Length:	26" (66.0 cm)
Width:	13" (33.0 cm)
Height ₁ :	3" (7.62 cm)
Height ₂ :	7" (17.8 cm)
Weight (max):	16 lbs (7.25 kg)

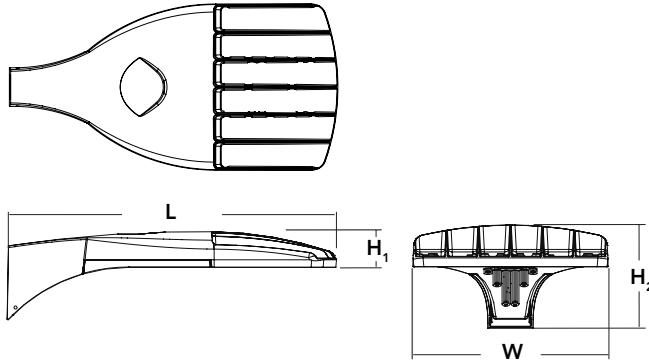

Introduction

The modern styling of the D-Series is striking yet unobtrusive - making a bold, progressive statement even as it blends seamlessly with its environment. The D-Series distills the benefits of the latest in LED technology into a high performance, high efficacy, long-life luminaire. The outstanding photometric performance results in sites with excellent uniformity, greater pole spacing and lower power density. It is ideal for replacing up to 400W metal halide with typical energy savings of 70% and expected service life of over 100,000 hours.

A+ Capable options indicated by this color background.

Ordering Information

EXAMPLE: DSX0 LED P6 40K T3M MVOLT SPA NLTAIR2 PIRHN DDBXD

Series	LEDs	Color temperature	Distribution	Voltage	Mounting
DSX0 LED					
DSX0 LED	Forward optics P1 P4 P7 P2 P5 P3 P6 Rotated optics P10 ¹ P12 ¹ P11 ¹ P13 ¹	30K 3000 K 40K 4000 K 50K 5000 K	T1S Type I short T2S Type II short T2M Type II medium T3S Type III short T3M Type III medium T4M Type IV medium TFTM Forward throw medium T5VS Type V very short T5S Type V short T5M Type V medium T5W Type V wide BLC Backlight control ² LCCO Left corner cutoff ² RCCO Right corner cutoff ²	MVOLT ^{3,4} 120 ⁴ 208 ⁴ 240 ⁴ 277 ⁴ 347 ^{4,5} 480 ^{4,5}	Shipped included SPA Square pole mounting RPA Round pole mounting WBA Wall bracket SPUMBA Square pole universal mounting adaptor ⁶ RPUMBA Round pole universal mounting adaptor ⁶ Shipped separately KMA8 DDBXD U Mast arm mounting bracket adaptor (specify finish) ⁷

Control options	Other options	Finish (required)
Shipped installed NLTAIR2 nLight AIR generation 2 enabled ^{8,9} PIRHN Network, high/low motion/ambient sensor ¹⁰ PER NEMA twist-lock receptacle only (control ordered separate) ¹¹ PER5 Five-pin receptacle only (control ordered separate) ^{11,12} PER7 Seven-pin receptacle only (leads exit fixture) (control ordered separate) ^{11,12} DMG 0-10V dimming extend out back of housing for external control (control ordered separate)	PIR High/low, motion/ambient sensor, 8-15' mounting height, ambient sensor enabled at 5fc ^{13,14} PIRH High/low, motion/ambient sensor, 15-30' mounting height, ambient sensor enabled at 5fc ^{13,14} PIR1FC3V High/low, motion/ambient sensor, 8-15' mounting height, ambient sensor enabled at 1fc ^{13,14} PIRH1FC3V High/low, motion/ambient sensor, 15-30' mounting height, ambient sensor enabled at 1fc ^{13,14} FAO Field adjustable output ¹⁵	Shipped installed HS House-side shield ¹⁶ SF Single fuse (120, 277, 347V) ⁴ DF Double fuse (208, 240, 480V) ⁴ L90 Left rotated optics ¹ R90 Right rotated optics ¹ DDL Diffused drop lens ¹⁶ Shipped separately BS Bird spikes ¹⁷ EGS External glare shield ¹⁷
		DDBXD Dark bronze DBLXD Black DNAXD Natural aluminum DWHXD White DDBTXD Textured dark bronze DBLBXD Textured black DNATXD Textured natural aluminum DWHGXD Textured white



Ordering Information

Accessories

Ordered and shipped separately.

DLL127F 1.5 JU	Photocell - SSL twist-lock (120-277V) ¹⁸
DLL347F 1.5 CUL JU	Photocell - SSL twist-lock (347V) ¹⁸
DLL480F 1.5 CUL JU	Photocell - SSL twist-lock (480V) ¹⁸
DSHORT SBK U	Shorting cap ¹⁸
DSX0HS 20C U	House-side shield for P1,P2,P3 and P4 ¹⁵
DSX0HS 30C U	House-side shield for P10,P11,P12 and P13 ¹⁶
DSX0HS 40C U	House-side shield for P5,P6 AND P7 ¹⁶
DSX0DDL U	Diffused drop lens (polycarbonate) ¹⁵
PUMBA DDBXD U*	Square and round pole universal mounting bracket adaptor (specify finish) ¹⁹
KMA8 DDBXD U	Mast arm mounting bracket adaptor (specify finish) ¹⁹

For more control options, visit [DTL](#) and [ROAM](#) online. Link to [nLight Air 2](#)

NOTES

- 1 P10, P11, P12 and P13 and rotated options (L90 or R90) only available together.
- 2 Not available with HS or DDL.
- 3 MVOLT driver operates on any line voltage from 120-277V (50/60 Hz).
- 4 Single fuse (SF) requires 120V, 277V or 347V. Double fuse (DF) requires 208V, 240V or 480V.
- 5 Not available in P4, P7 or P13. Not available with BL30, BL50 or PNMT options.
- 6 Universal mounting brackets intended for retrofit on existing pre-drilled poles only. 1.5 G vibration load rating per ANCI C136.31.
- 7 Must order fixture with SPA mounting. Must be ordered as a separate accessory; see Accessories information. For use with 2-3/8" mast arm (not included).
- 8 Must be ordered with PIRHN.
- 9 Sensor cover available only in dark bronze, black, white and natural aluminum colors.
- 10 Must be ordered with NLTAIR2. For more information on nLight Air 2 [visit this link](#).
- 11 Photocell ordered and shipped as a separate line item from Acuity Brands Controls. See accessories. Shorting Cap included.
- 12 If ROAM[®] node required, it must be ordered and shipped as a separate line item from Acuity Brands Controls. Shorting Cap included.
- 13 Reference Motion Sensor table on page 3.
- 14 Reference PER Table on page 3 to see functionality.
- 15 Not available with other dimming controls options.
- 16 Not available with BLC, LCCO and RCCO distribution.
- 17 Must be ordered with fixture for factory pre-drilling.
- 18 Requires luminaire to be specified with PER, PER5 or PER7 option. See PER Table on page 3.
- 19 For retrofit use only.

EGS – External Glare Shield

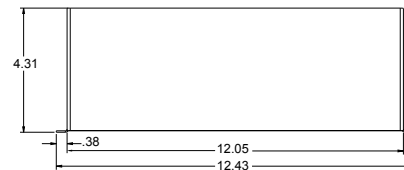
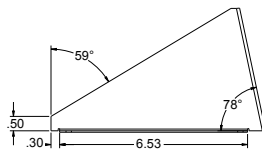
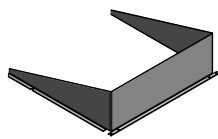

Drilling

HANDHOLE ORIENTATION (from top of pole)

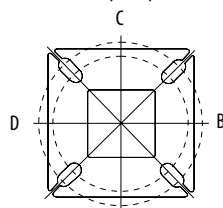

A
Handhole

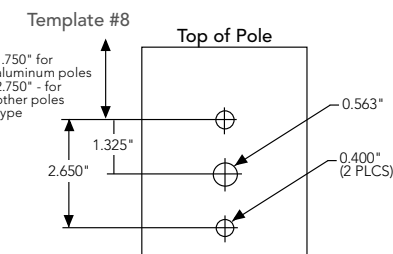

Tenon Mounting Slipfitter

Tenon O.D.	Single Unit	2 at 180°	2 at 90°	3 at 120°	3 at 90°	4 at 90°
2-3/8"	AST20-190	AST20-280	AST20-290	AST20-320	AST20-390	AST20-490
2-7/8"	AST25-190	AST25-280	AST25-290	AST25-320	AST25-390	AST25-490
4"	AST35-190	AST35-280	AST35-290	AST35-320	AST35-390	AST35-490

Mounting Option	Drilling Template	Single	2 @ 180	2 @ 90	3 @ 90	3 @ 120	4 @ 90
Head Location		Side B	Side B & D	Side B & C	Side B, C & D	Round Pole Only	Side A, B, C & D
Drill Nomenclature	#8	DM19AS	DM28AS	DM29AS	DM39AS	DM32AS	DM49AS
Minimum Acceptable Outside Pole Dimension							
SPA	#8	2-7/8"	2-7/8"	3.5"	3.5"		3.5"
RPA	#8	2-7/8"	2-7/8"	3.5"	3.5"	3"	3.5"
SPUMBA	#5	2-7/8"	3"	4"	4"		4"
RPUMBA	#5	2-7/8"	3.5"	5"	5"	3.5"	5"

Isofootcandle plots for the DSX0 LED 40C 1000 40K. Distances are in units of mounting height (20').

LEGEND

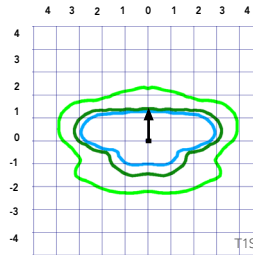
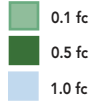

Test No.

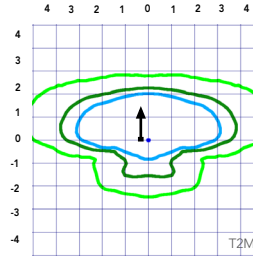

Test No.

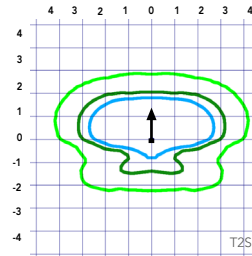

Test No. LTL23457P25 tested in accordance with IESNA LM-79-08.

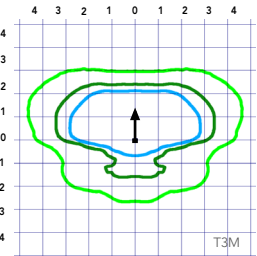

Test No. LTL23457P25 tested in accordance with IESNA LM-79-08.

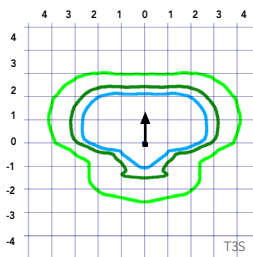

Test No. LTL23457P25 tested in accordance with IESNA LM-79-08.

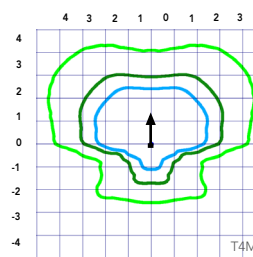

Test No.

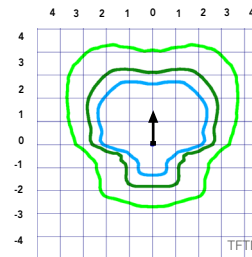

Test No.

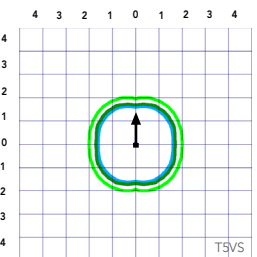

Test No.

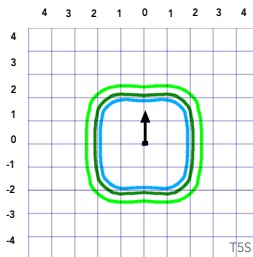

Test No.

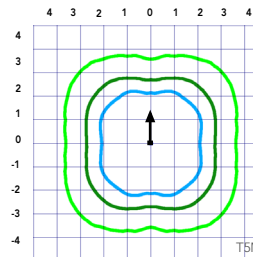

Test No.

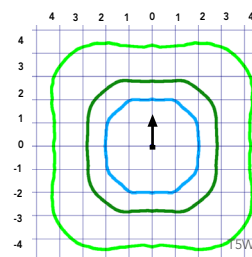

Test No. LTL23451P25 tested in accordance with IESNA LM-79-08.

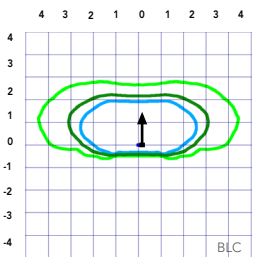

Test No.

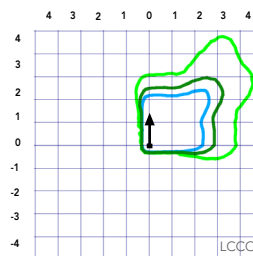

Test No.

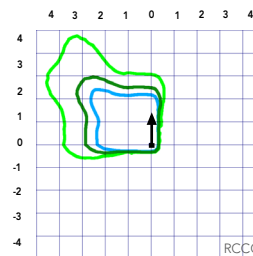

Test No.

Performance Data

Lumen Ambient Temperature (LAT) Multipliers

Use these factors to determine relative lumen output for average ambient temperatures from 0-40°C (32-104°F).

Ambient		Lumen Multiplier
0°C	32°F	1.04
5°C	41°F	1.04
10°C	50°F	1.03
15°C	59°F	1.02
20°C	68°F	1.01
25°C	77°C	1.00
30°C	86°F	0.99
35°C	95°F	0.98
40°C	104°F	0.97

Projected LED Lumen Maintenance

Data references the extrapolated performance projections for the platforms noted in a **25°C ambient**, based on 10,000 hours of LED testing (tested per IESNA LM-80-08 and projected per IESNA TM-21-11).

To calculate LLF, use the lumen maintenance factor that corresponds to the desired number of operating hours below. For other lumen maintenance values, contact factory.

Operating Hours	Lumen Maintenance Factor
25,000	0.96
50,000	0.92
100,000	0.85

Motion Sensor Default Settings						
Option	Dimmed State	High Level (when triggered)	Photocell Operation	Dwell Time	Ramp-up Time	Ramp-down Time
PIR or PIRH	3V (37%) Output	10V (100%) Output	Enabled @ 5FC	5 min	3 sec	5 min
*PIR1FC3V or PIRH1FC3V	3V (37%) Output	10V (100%) Output	Enabled @ 1FC	5 min	3 sec	5 min

*for use with separate Dusk to Dawn or timer.

Electrical Load

					Current (A)					
	Performance Package	LED Count	Drive Current	Wattage	120	208	240	277	347	480
Forward Optics (Non-Rotated)	P1	20	530	38	0.32	0.18	0.15	0.15	0.10	0.08
	P2	20	700	49	0.41	0.23	0.20	0.19	0.14	0.11
	P3	20	1050	71	0.60	0.37	0.32	0.27	0.21	0.15
	P4	20	1400	92	0.77	0.45	0.39	0.35	0.28	0.20
	P5	40	700	89	0.74	0.43	0.38	0.34	0.26	0.20
	P6	40	1050	134	1.13	0.65	0.55	0.48	0.39	0.29
	P7	40	1300	166	1.38	0.80	0.69	0.60	0.50	0.37
Rotated Optics (Requires L90 or R90)	P10	30	530	53	0.45	0.26	0.23	0.21	0.16	0.12
	P11	30	700	72	0.60	0.35	0.30	0.27	0.20	0.16
	P12	30	1050	104	0.88	0.50	0.44	0.39	0.31	0.23
	P13	30	1300	128	1.08	0.62	0.54	0.48	0.37	0.27

Controls Options

Nomenclature	Description	Functionality	Primary control device	Notes
FAO	Field adjustable output device installed inside the luminaire; wired to the driver dimming leads.	Allows the luminaire to be manually dimmed, effectively trimming the light output.	FAO device	Cannot be used with other controls options that need the 0-10V leads
DS	Drivers wired independently for 50/50 luminaire operation	The luminaire is wired to two separate circuits, allowing for 50/50 operation.	Independently wired drivers	Requires two separately switched circuits. Consider nLight AIR as a more cost effective alternative.
PERS or PER7	Twist-lock photocell receptacle	Compatible with standard twist-lock photocells for dusk to dawn operation, or advanced control nodes that provide 0-10V dimming signals.	Twist-lock photocells such as DLL Elite or advanced control nodes such as ROAM.	Pins 4 & 5 to dimming leads on driver, Pins 6 & 7 are capped inside luminaire
PIR or PIRH	Motion sensors with integral photocell. PIR for 8-15' mounting; PIRH for 15-30' mounting	Luminaires dim when no occupancy is detected.	Acuity Controls SBOR	Also available with PIRH1FC3V when the sensor photocell is used for dusk-to-dawn operation.
NLTAIR2 PIRHN	nLight AIR enabled luminaire for motion sensing, photocell and wireless communication.	Motion and ambient light sensing with group response. Scheduled dimming with motion sensor over-ride when wirelessly connected to the nLight Eclipse.	nLight Air rSDGR	nLight AIR sensors can be programmed and commissioned from the ground using the CIAIRity Pro app.

Performance Data

Lumen Output

Lumen values are from photometric tests performed in accordance with IESNA LM-79-08. Data is considered to be representative of the configurations shown, within the tolerances allowed by Lighting Facts. Contact factory for performance data on any configurations not shown here.

Forward Optics																							
Power Package	LED Count	Drive Current	System Watts	Dist. Type	30K (3000 K, 70 CRI)					40K (4000 K, 70 CRI)					50K (5000 K, 70 CRI)								
					Lumens	B	U	G	LPW	Lumens	B	U	G	LPW	Lumens	B	U	G	LPW				
P1	20	530	38W	T1S	4,369	1	0	1	115	4,706	1	0	1	124	4,766	1	0	1	125				
				T2S	4,364	1	0	1	115	4,701	1	0	1	124	4,761	1	0	1	125				
				T2M	4,387	1	0	1	115	4,726	1	0	1	124	4,785	1	0	1	126				
				T3S	4,248	1	0	1	112	4,577	1	0	1	120	4,634	1	0	1	122				
				T3M	4,376	1	0	1	115	4,714	1	0	1	124	4,774	1	0	1	126				
				T4M	4,281	1	0	1	113	4,612	1	0	2	121	4,670	1	0	2	123				
				TFTM	4,373	1	0	1	115	4,711	1	0	2	124	4,771	1	0	2	126				
				TSVS	4,548	2	0	0	120	4,900	2	0	0	129	4,962	2	0	0	131				
				TSS	4,552	2	0	0	120	4,904	2	0	0	129	4,966	2	0	0	131				
				TSM	4,541	3	0	1	120	4,891	3	0	1	129	4,953	3	0	1	130				
				TSW	4,576	3	0	2	120	4,929	3	0	2	130	4,992	3	0	2	131				
				BLC	3,586	1	0	1	94	3,863	1	0	1	102	3,912	1	0	1	103				
				LCCO	2,668	1	0	1	70	2,874	1	0	2	76	2,911	1	0	2	77				
				RCCO	2,668	1	0	1	70	2,874	1	0	2	76	2,911	1	0	2	77				
				P2	20	700	49W	T1S	5,570	1	0	1	114	6,001	1	0	1	122	6,077	2	0	2	124
								T2S	5,564	1	0	2	114	5,994	1	0	2	122	6,070	2	0	2	124
T2M	5,593	1	0					1	114	6,025	1	0	1	123	6,102	1	0	1	125				
T3S	5,417	1	0					2	111	5,835	1	0	2	119	5,909	2	0	2	121				
T3M	5,580	1	0					2	114	6,011	1	0	2	123	6,087	1	0	2	124				
T4M	5,458	1	0					2	111	5,880	1	0	2	120	5,955	1	0	2	122				
TFTM	5,576	1	0					2	114	6,007	1	0	2	123	6,083	1	0	2	124				
TSVS	5,799	2	0					0	118	6,247	2	0	0	127	6,327	2	0	0	129				
TSS	5,804	2	0					0	118	6,252	2	0	0	128	6,332	2	0	1	129				
TSM	5,789	3	0					1	118	6,237	3	0	1	127	6,316	3	0	1	129				
TSW	5,834	3	0					2	119	6,285	3	0	2	128	6,364	3	0	2	130				
BLC	4,572	1	0					1	93	4,925	1	0	1	101	4,987	1	0	1	102				
LCCO	3,402	1	0					2	69	3,665	1	0	2	75	3,711	1	0	2	76				
RCCO	3,402	1	0					2	69	3,665	1	0	2	75	3,711	1	0	2	76				
P3	20	1050	71W					T1S	7,833	2	0	2	110	8,438	2	0	2	119	8,545	2	0	2	120
								T2S	7,825	2	0	2	110	8,429	2	0	2	119	8,536	2	0	2	120
				T2M	7,865	2	0	2	111	8,473	2	0	2	119	8,580	2	0	2	121				
				T3S	7,617	2	0	2	107	8,205	2	0	2	116	8,309	2	0	2	117				
				T3M	7,846	2	0	2	111	8,452	2	0	2	119	8,559	2	0	2	121				
				T4M	7,675	2	0	2	108	8,269	2	0	2	116	8,373	2	0	2	118				
				TFTM	7,841	2	0	2	110	8,447	2	0	2	119	8,554	2	0	2	120				
				TSVS	8,155	3	0	0	115	8,785	3	0	0	124	8,896	3	0	0	125				
				TSS	8,162	3	0	1	115	8,792	3	0	1	124	8,904	3	0	1	125				
				TSM	8,141	3	0	2	115	8,770	3	0	2	124	8,881	3	0	2	125				
				TSW	8,204	3	0	2	116	8,838	4	0	2	124	8,950	4	0	2	126				
				BLC	6,429	1	0	2	91	6,926	1	0	2	98	7,013	1	0	2	99				
				LCCO	4,784	1	0	2	67	5,153	1	0	2	73	5,218	1	0	2	73				
				RCCO	4,784	1	0	2	67	5,153	1	0	2	73	5,218	1	0	2	73				
				P4	20	1400	92W	T1S	9,791	2	0	2	106	10,547	2	0	2	115	10,681	2	0	2	116
								T2S	9,780	2	0	2	106	10,536	2	0	2	115	10,669	2	0	2	116
T2M	9,831	2	0					2	107	10,590	2	0	2	115	10,724	2	0	2	117				
T3S	9,521	2	0					2	103	10,256	2	0	2	111	10,386	2	0	2	113				
T3M	9,807	2	0					2	107	10,565	2	0	2	115	10,698	2	0	2	116				
T4M	9,594	2	0					2	104	10,335	2	0	3	112	10,466	2	0	3	114				
TFTM	9,801	2	0					2	107	10,558	2	0	2	115	10,692	2	0	2	116				
TSVS	10,193	3	0					1	111	10,981	3	0	1	119	11,120	3	0	1	121				
TSS	10,201	3	0					1	111	10,990	3	0	1	119	11,129	3	0	1	121				
TSM	10,176	4	0					2	111	10,962	4	0	2	119	11,101	4	0	2	121				
TSW	10,254	4	0					3	111	11,047	4	0	3	120	11,186	4	0	3	122				
BLC	8,036	1	0					2	87	8,656	1	0	2	94	8,766	1	0	2	95				
LCCO	5,979	1	0					2	65	6,441	1	0	2	70	6,523	1	0	3	71				
	5,979	1	0					2	65	6,441	1	0	2	70	6,523	1	0	3	71				

Performance Data

Lumen Output

Lumen values are from photometric tests performed in accordance with IESNA LM-79-08. Data is considered to be representative of the configurations shown, within the tolerances allowed by Lighting Facts. Contact factory for performance data on any configurations not shown here.

Forward Optics																			
Power Package	LED Count	Drive Current	System Watts	Dist. Type	30K (3000 K, 70 CRI)					40K (4000 K, 70 CRI)					50K (5000 K, 70 CRI)				
					Lumens	B	U	G	LPW	Lumens	B	U	G	LPW	Lumens	B	U	G	LPW
P5	40	700	89W	T1S	10,831	2	0	2	122	11,668	2	0	2	131	11,816	2	0	2	133
				T2S	10,820	2	0	2	122	11,656	2	0	2	131	11,803	2	0	2	133
				T2M	10,876	2	0	2	122	11,716	2	0	2	132	11,864	2	0	2	133
				T3S	10,532	2	0	2	118	11,346	2	0	2	127	11,490	2	0	2	129
				T3M	10,849	2	0	2	122	11,687	2	0	2	131	11,835	2	0	2	133
				T4M	10,613	2	0	3	119	11,434	2	0	3	128	11,578	2	0	3	130
				TFTM	10,842	2	0	2	122	11,680	2	0	2	131	11,828	2	0	2	133
				TSVS	11,276	3	0	1	127	12,148	3	0	1	136	12,302	3	0	1	138
				T5S	11,286	3	0	1	127	12,158	3	0	1	137	12,312	3	0	1	138
				T5M	11,257	4	0	2	126	12,127	4	0	2	136	12,280	4	0	2	138
				T5W	11,344	4	0	3	127	12,221	4	0	3	137	12,375	4	0	3	139
				BLC	8,890	1	0	2	100	9,576	1	0	2	108	9,698	1	0	2	109
				LCCO	6,615	1	0	3	74	7,126	1	0	3	80	7,216	1	0	3	81
				RCCO	6,615	1	0	3	74	7,126	1	0	3	80	7,216	1	0	3	81
				P6	40	1050	134W	T1S	14,805	3	0	3	110	15,949	3	0	3	119	16,151
T2S	14,789	3	0					3	110	15,932	3	0	3	119	16,134	3	0	3	120
T2M	14,865	3	0					3	111	16,014	3	0	3	120	16,217	3	0	3	121
T3S	14,396	3	0					3	107	15,509	3	0	3	116	15,705	3	0	3	117
T3M	14,829	2	0					3	111	15,975	3	0	3	119	16,177	3	0	3	121
T4M	14,507	2	0					3	108	15,628	3	0	3	117	15,826	3	0	3	118
TFTM	14,820	2	0					3	111	15,965	3	0	3	119	16,167	3	0	3	121
TSVS	15,413	4	0					1	115	16,604	4	0	1	124	16,815	4	0	1	125
T5S	15,426	3	0					1	115	16,618	4	0	1	124	16,828	4	0	1	126
T5M	15,387	4	0					2	115	16,576	4	0	2	124	16,786	4	0	2	125
T5W	15,506	4	0					3	116	16,704	4	0	3	125	16,915	4	0	3	126
BLC	12,151	1	0					2	91	13,090	1	0	2	98	13,255	1	0	2	99
LCCO	9,041	1	0					3	67	9,740	1	0	3	73	9,863	1	0	3	74
RCCO	9,041	1	0					3	67	9,740	1	0	3	73	9,863	1	0	3	74
P7	40	1300	166W					T1S	17,023	3	0	3	103	18,338	3	0	3	110	18,570
				T2S	17,005	3	0	3	102	18,319	3	0	3	110	18,551	3	0	3	112
				T2M	17,092	3	0	3	103	18,413	3	0	3	111	18,646	3	0	3	112
				T3S	16,553	3	0	3	100	17,832	3	0	3	107	18,058	3	0	3	109
				T3M	17,051	3	0	3	103	18,369	3	0	3	111	18,601	3	0	3	112
				T4M	16,681	3	0	3	100	17,969	3	0	3	108	18,197	3	0	3	110
				TFTM	17,040	3	0	3	103	18,357	3	0	4	111	18,590	3	0	4	112
				TSVS	17,723	4	0	1	107	19,092	4	0	1	115	19,334	4	0	1	116
				T5S	17,737	4	0	2	107	19,108	4	0	2	115	19,349	4	0	2	117
				T5M	17,692	4	0	2	107	19,059	4	0	2	115	19,301	4	0	2	116
				T5W	17,829	5	0	3	107	19,207	5	0	3	116	19,450	5	0	3	117
				BLC	13,971	2	0	2	84	15,051	2	0	2	91	15,241	2	0	2	92
				LCCO	10,396	1	0	3	63	11,199	1	0	3	67	11,341	1	0	3	68
					10,396	1	0	3	63	11,199	1	0	3	67	11,341	1	0	3	68

Performance Data

Lumen Output

Lumen values are from photometric tests performed in accordance with IESNA LM-79-08. Data is considered to be representative of the configurations shown, within the tolerances allowed by Lighting Facts. Contact factory for performance data on any configurations not shown here.

Rotated Optics																							
Power Package	LED Count	Drive Current	System Watts	Dist. Type	30K (3000 K, 70 CRI)					40K (4000 K, 70 CRI)					50K (5000 K, 70 CRI)								
					Lumens	B	U	G	LPW	Lumens	B	U	G	LPW	Lumens	B	U	G	LPW				
P10	30	530	53W	T1S	6,727	2	0	2	127	7,247	3	0	3	137	7,339	3	0	3	138				
				T2S	6,689	3	0	3	126	7,205	3	0	3	136	7,297	3	0	3	138				
				T2M	6,809	3	0	3	128	7,336	3	0	3	138	7,428	3	0	3	140				
				T3S	6,585	3	0	3	124	7,094	3	0	3	134	7,183	3	0	3	136				
				T3M	6,805	3	0	3	128	7,331	3	0	3	138	7,424	3	0	3	140				
				T4M	6,677	3	0	3	126	7,193	3	0	3	136	7,284	3	0	3	137				
				TFTM	6,850	3	0	3	129	7,379	3	0	3	139	7,472	3	0	3	141				
				TSVS	6,898	3	0	0	130	7,431	3	0	0	140	7,525	3	0	0	142				
				T5S	6,840	2	0	1	129	7,368	2	0	1	139	7,461	2	0	1	141				
				T5M	6,838	3	0	1	129	7,366	3	0	2	139	7,460	3	0	2	141				
				TSW	6,777	3	0	2	128	7,300	3	0	2	138	7,393	3	0	2	139				
				BLC	5,626	2	0	2	106	6,060	2	0	2	114	6,137	2	0	2	116				
				LCCO	4,018	1	0	2	76	4,328	1	0	2	82	4,383	1	0	2	83				
				RCCO	4,013	3	0	3	76	4,323	3	0	3	82	4,377	3	0	3	83				
				P11	30	700	72W	T1S	8,594	3	0	3	119	9,258	3	0	3	129	9,376	3	0	3	130
								T2S	8,545	3	0	3	119	9,205	3	0	3	128	9,322	3	0	3	129
T2M	8,699	3	0					3	121	9,371	3	0	3	130	9,490	3	0	3	132				
T3S	8,412	3	0					3	117	9,062	3	0	3	126	9,177	3	0	3	127				
T3M	8,694	3	0					3	121	9,366	3	0	3	130	9,484	3	0	3	132				
T4M	8,530	3	0					3	118	9,189	3	0	3	128	9,305	3	0	3	129				
TFTM	8,750	3	0					3	122	9,427	3	0	3	131	9,546	3	0	3	133				
TSVS	8,812	3	0					0	122	9,493	3	0	0	132	9,613	3	0	0	134				
T5S	8,738	3	0					1	121	9,413	3	0	1	131	9,532	3	0	1	132				
T5M	8,736	3	0					2	121	9,411	3	0	2	131	9,530	3	0	2	132				
TSW	8,657	4	0					2	120	9,326	4	0	2	130	9,444	4	0	2	131				
BLC	7,187	3	0					3	100	7,742	3	0	3	108	7,840	3	0	3	109				
LCCO	5,133	1	0					2	71	5,529	1	0	2	77	5,599	1	0	2	78				
RCCO	5,126	3	0					3	71	5,522	3	0	3	77	5,592	3	0	3	78				
P12	30	1050	104W					T1S	12,149	3	0	3	117	13,088	3	0	3	126	13,253	3	0	3	127
								T2S	12,079	4	0	4	116	13,012	4	0	4	125	13,177	4	0	4	127
				T2M	12,297	3	0	3	118	13,247	3	0	3	127	13,415	3	0	3	129				
				T3S	11,891	4	0	4	114	12,810	4	0	4	123	12,972	4	0	4	125				
				T3M	12,290	3	0	3	118	13,239	4	0	4	127	13,407	4	0	4	129				
				T4M	12,058	4	0	4	116	12,990	4	0	4	125	13,154	4	0	4	126				
				TFTM	12,369	4	0	4	119	13,325	4	0	4	128	13,494	4	0	4	130				
				TSVS	12,456	3	0	1	120	13,419	3	0	1	129	13,589	4	0	1	131				
				T5S	12,351	3	0	1	119	13,306	3	0	1	128	13,474	3	0	1	130				
				T5M	12,349	4	0	2	119	13,303	4	0	2	128	13,471	4	0	2	130				
				TSW	12,238	4	0	3	118	13,183	4	0	3	127	13,350	4	0	3	128				
				BLC	10,159	3	0	3	98	10,944	3	0	3	105	11,083	3	0	3	107				
				LCCO	7,256	1	0	3	70	7,816	1	0	3	75	7,915	1	0	3	76				
				RCCO	7,246	3	0	3	70	7,806	4	0	4	75	7,905	4	0	4	76				
				P13	30	1300	128W	T1S	14,438	3	0	3	113	15,554	3	0	3	122	15,751	3	0	3	123
								T2S	14,355	4	0	4	112	15,465	4	0	4	121	15,660	4	0	4	122
T2M	14,614	3	0					3	114	15,744	4	0	4	123	15,943	4	0	4	125				
T3S	14,132	4	0					4	110	15,224	4	0	4	119	15,417	4	0	4	120				
T3M	14,606	4	0					4	114	15,735	4	0	4	123	15,934	4	0	4	124				
T4M	14,330	4	0					4	112	15,438	4	0	4	121	15,633	4	0	4	122				
TFTM	14,701	4	0					4	115	15,836	4	0	4	124	16,037	4	0	4	125				
TSVS	14,804	4	0					1	116	15,948	4	0	1	125	16,150	4	0	1	126				
T5S	14,679	3	0					1	115	15,814	3	0	1	124	16,014	3	0	1	125				
T5M	14,676	4	0					2	115	15,810	4	0	2	124	16,010	4	0	2	125				
TSW	14,544	4	0					3	114	15,668	4	0	3	122	15,866	4	0	3	124				
BLC	7919	3	0					3	62	8531	3	0	3	67	8639	3	0	3	67				
LCCO	5145	1	0					2	40	5543	1	0	2	43	5613	1	0	2	44				
	5139	3	0					3	40	5536	3	0	3	43	5606	3	0	3	44				

Capable Luminaire

This item is an A+ capable luminaire, which has been designed and tested to provide consistent color appearance and system-level interoperability.

- All configurations of this luminaire meet the Acuity Brands' specification for chromatic consistency
- This luminaire is A+ Certified when ordered with DTL® controls marked by a shaded background. DTL DLL equipped luminaires meet the A+ specification for luminaire to photocontrol interoperability¹
- This luminaire is part of an A+ Certified solution for ROAM® or XPoint™ Wireless control networks, providing out-of-the-box control compatibility with simple commissioning, when ordered with drivers and control options marked by a shaded background¹

To learn more about A+, visit www.acuitybrands.com/aplus.

1. See ordering tree for details.
2. A+ Certified Solutions for ROAM require the order of one ROAM node per luminaire.
Sold Separately: [Link to Roam](#); [Link to DTL DLL](#)

FEATURES & SPECIFICATIONS

INTENDED USE

The sleek design of the D-Series Size 0 reflects the embedded high performance LED technology. It is ideal for many commercial and municipal applications, such as parking lots, plazas, campuses, and pedestrian areas.

CONSTRUCTION

Single-piece die-cast aluminum housing has integral heat sink fins to optimize thermal management through conductive and convective cooling. Modular design allows for ease of maintenance and future light engine upgrades. The LED driver is mounted in direct contact with the casting to promote low operating temperature and long life. Housing is completely sealed against moisture and environmental contaminants (IP65). Low EPA (0.95 ft²) for optimized pole wind loading.

FINISH

Exterior parts are protected by a zinc-infused Super Durable TGIC thermoset powder coat finish that provides superior resistance to corrosion and weathering. A tightly controlled multi-stage process ensures a minimum 3 mils thickness for a finish that can withstand extreme climate changes without cracking or peeling. Available in both textured and non-textured finishes.

OPTICS

Precision-molded proprietary acrylic lenses are engineered for superior area lighting distribution, uniformity, and pole spacing. Light engines are available in 3000 K, 4000 K or 5000 K (70 CRI) configurations. The D-Series Size 0 has zero uplight and qualifies as a Nighttime Friendly™ product, meaning it is consistent with the LEED® and Green Globes™ criteria for eliminating wasteful uplight.

ELECTRICAL

Light engine(s) configurations consist of high-efficacy LEDs mounted to metal-core circuit boards to maximize heat dissipation and promote long life (up to L85/100,000 hours at 25°C). Class 1 electronic drivers are designed to have a power factor >90%, THD <20%, and an expected life of 100,000 hours with <1% failure rate. Easily serviceable 10kV surge protection device meets a minimum Category C Low operation (per ANSI/IEEE C62.41.2).

STANDARD CONTROLS

The DSX0 LED area luminaire has a number of control options. Dusk to dawn controls can be utilized via optional NEMA twist-lock photocell receptacles. Integrated motion sensors with on-board photocells feature field-adjustable programming and are suitable for mounting heights up to 30 feet.

nLIGHT AIR CONTROLS

The DSX0 LED area luminaire is also available with nLight® AIR for the ultimate in wireless control. This powerful controls platform provides out-of-the-box basic motion sensing and photocontrol functionality and is suitable for mounting heights up to 40 feet. Once commissioned using a smartphone and the easy-to-use CLAIRITY app, nLight AIR equipped luminaires can be grouped, resulting in motion sensor and photocell group response without the need for additional equipment. Scheduled dimming with motion sensor over-ride can be achieved when used with the nLight Eclipse. Additional information about nLight Air can be found [here](#).

INSTALLATION

Included mounting block and integral arm facilitate quick and easy installation. Stainless steel bolts fasten the mounting block securely to poles and walls, enabling the D-Series Size 0 to withstand up to a 3.0 G vibration load rating per ANSI C136.31. The D-Series Size 0 utilizes the AERIS™ series pole drilling pattern (template #8). Optional terminal block and NEMA photocell receptacle are also available.

LISTINGS

UL Listed for wet locations. Light engines are IP66 rated; luminaire is IP65 rated. Rated for -40°C minimum ambient. U.S. Patent No. D672,492 S. International patent pending.

DesignLights Consortium® (DLC) Premium qualified product and DLC qualified product. Not all versions of this product may be DLC Premium qualified or DLC qualified. Please check the DLC Qualified Products List at www.designlights.org/QPL to confirm which versions are qualified.

International Dark-Sky Association (IDA) Fixture Seal of Approval (FSA) is available for all products on this page utilizing 3000K color temperature only.

WARRANTY

5-year limited warranty. Complete warranty terms located at: www.acuitybrands.com/resources/terms-and-conditions

Note: Actual performance may differ as a result of end-user environment and application.

All values are design or typical values, measured under laboratory conditions at 25 °C.

Specifications subject to change without notice.



COMMERCIAL OUTDOOR

One Lithonia Way • Conyers, Georgia 30012 • Phone: 800.705.7378 • www.lithonia.com
© 2011-2019 Acuity Brands Lighting, Inc. All rights reserved.

DSX0-LED
Rev. 08/15/19
Page 8 of 8