

## FEATURES & SPECIFICATIONS

**INTENDED USE** — The BLWP LED Wrap/Wall bracket expands the BLT family with the features and aesthetics of the popular BLT center basket design with a clean, versatile style and volumetric distribution. High efficacy LED light engines deliver energy savings and low maintenance compared to traditional sources. An extensive selection of configurations and options make the BLWP the perfect choice for many lighting applications including schools, offices, stairwells and other commercial spaces. With multiple mounting options, easy installation, and controls configurations, the BLWP is an excellent choice for renovation and new construction.

BLWP Tunable White is perfect in classrooms and educational settings as it allows the light color temperature to be adjusted to the optimal light level for student tasks such as reading or test taking.

**CONSTRUCTION** — BLWP enclosure components are die-formed for dimensional consistency. For 2' and 4' product, hinged door frame allows easy access to electrical components and mounting locations without having to remove additional parts. For 8' product, suspension aircraft cables allow easy access to electrical components and mounting locations without having to remove additional parts. Available in three paint finishes: white (pre-paint), painted after fabrication white, and natural aluminum. Diffusers are extruded from impact modified acrylic for increased durability. Optional polycarbonate lens available for additional impact resistance, as well as Tamper Proof screws.

**OPTICS** — Volumetric illumination is achieved by creating an optimal mix of light to walls, partitions and vertical and horizontal work surfaces — rendering the interior space, objects and occupants in a more balanced, complimentary luminous environment. High performance extruded acrylic diffusers conceal LEDs and efficiently deliver light in a volumetric distribution. Five diffuser choices available - curved and square designs with linear prisms, a smooth frosted finish, and a smooth polycarbonate finish.

**ELECTRICAL** — Long-life LEDs, coupled with high-efficiency drivers, provide superior quantity and quality of illumination for extended service life. 80% LED lumen maintenance at 60,000 hours (L80/60,000).

eldoLED driver options deliver choice of dimming range, and choices for control, while assuring flicker-free, low-current inrush, 89% efficiency and low EMI.

Integrated nLight® controls make each luminaire addressable — allowing it to digitally communicate with other nLight enabled controls such as dimmers, switches, occupancy sensors and photocontrols. Simply connect all the nLight enabled control devices and the BLT luminaires using standard Cat-5 cabling. Unique plug-and-play convenience as devices and luminaires automatically discover each other and self-commission.

Driver disconnect provided where required to comply with US and Canadian codes.

**Mainstream Dynamic Tunable White with nTune Technology:** Tunable white nTune™ is an all digital light color temperature control within an nLight enabled luminaire. This brings tunable white lighting control into the mainstream with repeatable, consistent results in an economical luminaire form and system already familiar to schools. Designers and facility operators are granted the freedom to tie scenes to specific activities or to complement colors or materials within a visual environment. nTune™ allows color temperature settings through the Productivity Range of 3000K-5000K or 2700K to 6500K (Rhythm Range). Refer to the Programming User's Guide for instructions on customizing to your application with SensorView.

**Integrated Sensor (nLight Wired Networking):** This sensor is nLight-enabled, meaning it has the ability to communicate over an nLight network. When wired, using CAT-5 cabling, with other nLight-enabled sensors, power packs, or WallPods, an nLight control zone is created. Once linked to a Gateway, directly or via a Bridge, the zone becomes capable of remote status monitoring and control via SensorView software. See page 2 for the nLight sensor options.

**INSTALLATION** — Intended for surface or suspend mounting. For row mounting and quick mounting to junction boxes see accessories section. Suitable for damp location.

**LISTINGS** — CSA Certified to meet U.S. and Canadian standards. DesignLights Consortium® (DLC) qualified product. Not all versions of this product may be DLC qualified. Please check the DLC Qualified Products List at [www.designlights.org/QPL](http://www.designlights.org/QPL) to confirm which versions are qualified.

**WARRANTY** — 5-year limited warranty. This is the only warranty provided and no other statements in this specification sheet create any warranty of any kind. All other express and implied warranties are disclaimed. Complete warranty terms located at:

[www.acuitybrands.com/support/warranty/terms-and-conditions](http://www.acuitybrands.com/support/warranty/terms-and-conditions)

**NOTE:** Actual performance may differ as a result of end-user environment and application.

All values are design or typical values, measured under laboratory conditions at 25 °C.

Specifications subject to change without notice.

### Specifications

#### L24 Dimensions

Length: 24 (60.96)  
Width: 5.50 (13.97)  
Depth: 3.50 (8.89)

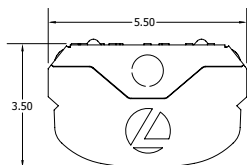

#### L48 Dimensions

Length: 48 (121.92)  
Width: 5.50 (13.97)  
Depth: 3.50 (8.89)

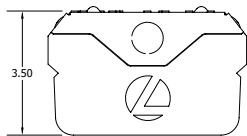

#### 8' Dimensions

Length: 96 (243.84)  
Width: 5.50 (13.97)  
Depth: 3.50 (8.89)

All dimensions are inches (centimeters) unless otherwise specified.

Catalog Number
Notes
Type

### Low Profile LED Wraparound

# BLWP Tunable White

2', 4' and 8' Lengths

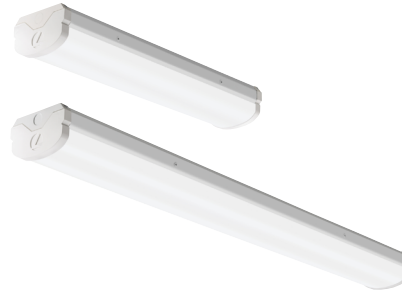

eldoLED



### Tunable White GPHD

- **Gamut:** One dimensional Warm-Cool
- **Path:** Direct 3000K to 5000K (Productivity Range) or 2700K to 6500K (Rhythm Range)
- **Handle:** Two Natural Language Handles: Intensity and CCT
- **Data:** nLight with nTune technology for both handles of control

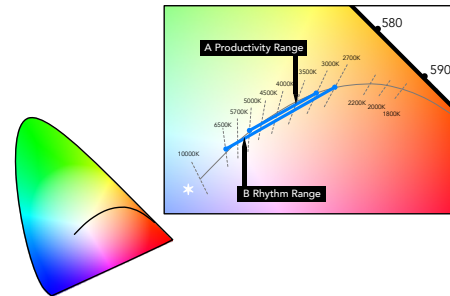

**A** Productivity Range 3000K to 5000K

**B** Rhythm Range 2700K to 6500K

### Multiple Diffuser Options

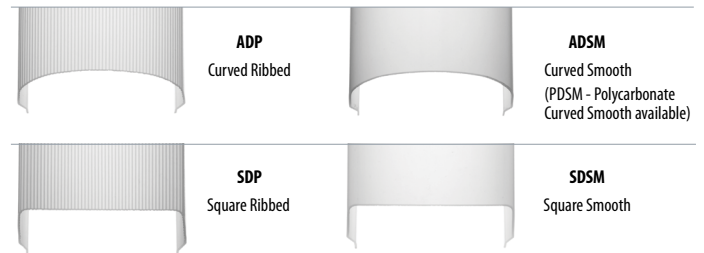

# BLWP Tunable White Low Profile LED Wraparound

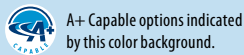

## ORDERING INFORMATION

Lead times will vary depending on options selected. Consult with your sales representative.

**Example:** BLWP4 TUWH PROR 40L ADSM NLT

Series	Dynamic Feature	Dynamic Range	Lumens <sup>1</sup>	Lens/Diffuser	Voltage	Control Interface
BLWP2 2' LED Wraparound	TUWH Tunable White	PROR Productivity Range (3000-5000K) RHYR Rhythm Range (27000K-6500K)	8L 800 Lumens	ADP Curved, linear prisms	(Blank) 120-277V	NLT nLight nTune interface <sup>2</sup>
BLWP4 4' LED Wraparound			20L 2000 Lumens	ADSM Curved, smooth	120 120V	
			33L 3300 Lumens	SDP Square, linear prisms	277 277V	
			40L 4000 Lumens	SDSM Square, smooth	347 347V <sup>2</sup>	
			15L 1500 Lumens	PDSM Curved, polycarbonate		
			20L 2000 Lumens	<b>Diffusers w/ trim rings</b>		
			30L 3000 Lumens	ADPT Curved, linear prisms		
			40L 4000 Lumens	ADSMT Curved, smooth		
BLWP8 8' LED Wraparound			48L 4800 Lumens	SDPT Square, linear prisms		
			60L 6000 Lumens	SDSMT Square, smooth		
			40L 4000 Lumens	PDSMT Curved, smooth polycarbonate		
			60L 6000 Lumens			
	80L 8000 Lumens					
		100L 10000 Lumens				
		140L 14000 Lumens				

Occupancy Control <sup>4</sup>	Options	Options
(blank) No sensor control	EL14L 1400 lumen battery pack (Noncompliant with CA T20) <sup>5</sup>	(Blank) Standard Pre-paint White
<b>nLight Wired Networking</b>	E10WLCP EM Self-Diagnostic battery pack, 10W Constant Power, Certified in CA Title 20 MAEDBS	PAF Paint After Fabrication White
NES7 nLight™ nES 7 PIR integral occupancy sensor	BGTD Bodine Generator Transfer Device <sup>6</sup>	DNA Natural Aluminum
NESPDT7 nLight™ nES PDT 7 dual technology integral occupancy control	QMB Quick Mount Bracket <sup>7</sup>	
NES7ADCX nLight™ nES 7 ADCX PIR integral occupancy sensor with automatic dimming photocell	TRS Tamper Resistant Screw <sup>8</sup>	
NESPDT7ADCX nLight™ nES PDT 7 dual technology integral occupancy sensor with automatic dimming photocell	GLR Fast-blowing fuse <sup>9</sup>	
	GMF Slow-blowing fuse <sup>9</sup>	
	PLR___ Plug-in wiring, see page 4 for ordering information <sup>10</sup>	
	BDP Factory Installed Ballast Disconnect Plug	

See Accessories on next page

### Notes

- 1 Approximate lumen output. All versions may not achieve 105+ LPW including versions with integral sensor trim. Refer to photometry on [www.acuitybrands.com](http://www.acuitybrands.com). See QPL for latest DLC listings.
- 2 Not available with E10WLCP, EL14L, or BGTD.
- 3 Requires power from nLight network bridge or NPS 80.
- 4 Must specify diffuser with trim rings. See sensor options in ordering information.
- 5 Only available on BLWP8, 8ft length version of this fixture.
- 6 Not available with emergency battery options. Must specify voltage. Requires BSE labeling, voltage specific. Consult factory for options. Example: BGTD BSE10.
- 7 Only available with BLWP4 (4') fixture.
- 8 Accessory BLWP TRS T15 BIT available to be ordered with this option. See Accessories section page 3. Order as separate item.
- 9 Must specify voltage. 120 or 277, with GLR and GMF fusing.
- 10 Not available with BLWP2.

# BLWP Tunable White Low Profile LED Wraparound

Accessories: Order as separate catalog number.				
PART number	CI CODE	QTY	Description	Application
BLWPCR	*250A0S	1	CONTINUOUS ROW MOUNT BRACKET WHT	FOR USE ON BLWP4 ONLY, FOR STD Finish AND PAF
BLWPCRDNA	*250A1S	1	CONTINUOUS ROW MOUNT BRACKET DNA	FOR USE ON BLWP4 ONLY, FOR DNA FINISH
BLWP8CR	*2543C6	1	CONTINUOUS ROW MOUNT BRACKET WHT	FOR USE ON BLWP8 ONLY, FOR STD Finish AND PAF
BLWP8CRDNA	*2543C6	1	CONTINUOUS ROW MOUNT BRACKET DNA	FOR USE ON BLWP8 ONLY, FOR DNA FINISH
BLWPCG36 F1	*264R3P	1	BLWPCG36 F1	ADJUSTABLE AIRCRAFT CABLE GRIPPER KIT, 36 INCH F1 CEILING TYPE
BLWPCG36 F2	*264R4G	1	BLWPCG36 F2	CABLE GRIPPER KIT, 36 INCH F2 CEILING TYPE
BLWPCG72 F1	*264R4H	1	BLWPCG72 F1	CABLE GRIPPER KIT, 72 INCH F1 CEILING TYPE
BLWPCG72 F2	*264R4M	1	BLWPCG72 F2	CABLE GRIPPER KIT, 72 INCH F2 CEILING TYPE
BLWPCGF36 F1	*264R4R	1	BLWPCGF36 F1	KIT WITH POWER FEED 36 INCH F1 CEILING TYPE
BLWPCGF36 F2	*264R4U	1	BLWPCGF36 F2	KIT WITH POWER FEED 36 INCH F2 CEILING TYPE
BLWPCGF72 F1	*264R4V	1	BLWPCGF72 F1	KIT WITH POWER FEED 72 INCH F1 CEILING TYPE
BLWPCGF72 F2	*264R4X	1	BLWPCGF72 F2	KIT WITH POWER FEED 72 INCH F2 CEILING TYPE
BLWPCGE36 F1	*264R50	1	BLWPCGE36 F1	KIT WITH EMERGENCY POWER FEED 36 INCH F1 CEILING TYPE
BLWPCGE36 F2	*264R5T	1	BLWPCGE36 F2	KIT WITH EMERGENCY POWER FEED 36 INCH F2 CEILING TYPE
BLWPCGE72 F1	*264R5V	1	BLWPCGE72 F1	KIT WITH EMERGENCY POWER FEED 72 INCH F1 CEILING TYPE
BLWPCGE72 F2	*264R53	1	BLWPCGE72 F2	KIT WITH EMERGENCY POWER FEED 72 INCH F2 CEILING TYPE
BLWP TRS T15 BIT	*2516KU	1	BLWP TRS T15 BIT	T15 with Pin, Torx bit for TRS option
BLWPQMB	*250A2S	1	BLWP Quick Mount Bracket	Quick Mount Bracket for installation to junction boxes without having to remove any parts in the fixture, 4ft fixture only.
RK8BDP 2P U			Disconnect Plug (BDP), 2 Pole, Package of 1	
RK8BDP 3P U			Disconnect Plug (BDP), 3 Pole, Package of 1	
RK8BDP 2P J10			Disconnect Plug (BDP), 2 Pole, Package of 10	
RK8BDP 2P J40			Disconnect Plug (BDP), 2 Pole, Package of 40	

nLight® Control Accessories: Order as separate catalog number. Visit <a href="http://www.acuitybrands.com/products/controls/nlight">www.acuitybrands.com/products/controls/nlight</a> .			
<b>WallPod stations</b>	<b>Model number</b>	<b>Occupancy sensors</b>	<b>Model number</b>
On/Off, Raise/Lower, 2 Pole, CCT change	nPODM 2P DX CCT	Small motion 360°, ceiling (PIR / dual tech)	nCM 9 RJB / nCM PDT 9 RJB
On/Off, CCT Select, Raise/Lower	nPODM 4S DX EDUTW	Large motion 360°, ceiling (PIR / dual tech)	nCM10 RJB / nCM PDT 10 RJB
CCT Select	nPODM 4S EDUTW	Wall switch with raise/lower	nWSX PDT LV DX [color]
<b>Photocell controls</b>	<b>Model number</b>	<b>Cat-5 cable (plenum rated)</b>	<b>Model number</b>
Full range dimming	nCM ADCX RJB	10' cable	CAT5 10FT J1
		30' cable	CAT5 30FT J1
<b>Power Supply</b>			
nLight Power Supply	nPS 80		

## A+ Capable Luminaire

This item is an A+ capable luminaire, which has been designed and tested to provide consistent color appearance and out-of-the-box control compatibility with simple commissioning.

- All configurations of this luminaire meet the Acuity Brands' specification for chromatic consistency
- This luminaire is part of an A+ Certified solution for nLight® control networks when ordered with drivers marked by a **shaded background\***
- This luminaire is part of an A+ Certified solution for nLight control networks, providing advanced control functionality at the luminaire level, when selection includes driver and control options marked by a **shaded background\***

To learn more about A+, visit [www.acuitybrands.com/aplus](http://www.acuitybrands.com/aplus).

\*See ordering tree for details

# BLWP Tunable White Low Profile LED Wraparound

## PRODUCT INFORMATION

Advanced plug-in system with three-circuit capability. Available on industrial and strip products and a variety of architectural products mounted in continuous rows. 1, 2, 3 and 4-lamp fixtures. PLR22 (2-circuit) and PLR33 (3-circuit) crossover harness switches hot circuit serving next fixture in row. Reduces fixture types on job for alternating circuit applications (see example below.)

Easy one-step installation, saves up to 35% on labor costs. Expanded switching flexibility helps save energy.

Rows can be 50% longer with two-circuit systems. Polarized, lock-together nylon connectors prevent miswiring in the field. #12 THHN conductor, rated 600V, 90°C. White neutral wire included. Grounding accomplished by fixture in-row connectors.

CSA certified systems available with up to 2 circuits. G ground required.

Note: Specifications subject to change without notice.



Wiring

# PLR

**Advanced 3-Circuit Plug-In**

### ORDERING INFORMATION

Lead times will vary depending on options selected. Consult with your sales representative.

Series	Number of hot wires		Branch circuits			Ground	
PLR	(blank)	Not required for 22 or 33	<u>Circuits to which ballast is connected</u>		<u>Emergency circuit connected</u>		(blank) No ground in PLR
PLR22	1	Black	(blank)	Not required for 22 or 33	(blank)	No emergency circuit	G Ground. Maximum 2 circuits
PLR33	2	Black and red	A	Black wire	ELA	Emergency circuit wired to black wire	
	3	Black, red and blue	B	Red wire	ELB	Emergency circuit wired to red wire	
			C	Blue wire	ELC	Emergency circuit wired to blue wire	

### Typical Applications

- Multiple-circuit and single-circuit for longer continuous rows
- Multiple-circuit with alternating fixtures on separate circuits, 2-circuit (PLR 22) and 3-circuit (PLR 33)
- Multiple circuit with night-lights located along row as desired

TYPICAL APPLICATIONS										
PLR 3 C	PLR 3 C	PLR 3 C	PLR 3 C	PLR 2 B	PLR 2 B	PLR 2 B	PLR 2 B	PLR 1	PLR 1	PLR 1
(All PLR22)										
Circuit A	Circuit B	Circuit A	Circuit B	Circuit A	Circuit B	Circuit A	Circuit B	Circuit A	Circuit B	Circuit A
(All PLR33)										
Circuit A	Circuit B	Circuit C	Circuit A	Circuit B	Circuit C	Circuit A	Circuit B	Circuit C	Circuit A	Circuit B
PLR 3 A	PLR 3 A	PLR 3 A	PLR 3 C	PLR 3 B	PLR 3 B	PLR 3 B	PLR 3 C	PLR 3 A	PLR 3 A	PLR 3 A

# BLWP Tunable White Low Profile LED Wraparound

Replacement Parts: Order as separate catalog number.					
2' Version Replacement Lens		4' Version Replacement Lens		8' Version Replacement Lens	
*264F5E	DBLWP24 ADP	*264F69	DBLWP48 ADP	*2543CE	DBLWP96 ADP
*264F5F	DBLWP24 SDP	*264F6E	DBLWP48 SDP	*2543CG	DBLWP96 SDP
*264F5H	DBLWP24 ADSM	*264F6F	DBLWP48 ADSM	*2543CJ	DBLWP96 ADSM
*264F5J	DBLWP24 SDSM	*264F6G	DBLWP48 SDSM	*2543CM	DBLWP96 SDSM
*264F5L	DBLWP24 ADPT	*264F6H	DBLWP48 ADPT	*2543CN	DBLWP96 ADPT
*264F5P	DBLWP24 SDPT	*264F6K	DBLWP48 SDPT	*2543CP	DBLWP96 SDPT
*264F5U	DBLWP24 ADSMT	*264F6L	DBLWP48 ADSMT	*2543CR	DBLWP96 ADSMT
*264F5W	DBLWP24 SDSMT	*264F6N	DBLWP48 SDSMT	*2543CS	DBLWP96 SDSMT
*264F66	DBLWP24 PDSM	*264F6W	DBLWP48 PDSM	*2543CW	DBLWP96 PDSM
*264F67	DBLWP24 PDSMT	*264F6X	DBLWP48 PDSMT	*2543CX	DBLWP96 PDSMT

## Tunable White Wall Pods



nPODM 2P DX CCT



nPODM 4S DX EDUTW



nPODM 4S EDUTW

### Typical nLight network layout with power supply, sensor and wallpod.

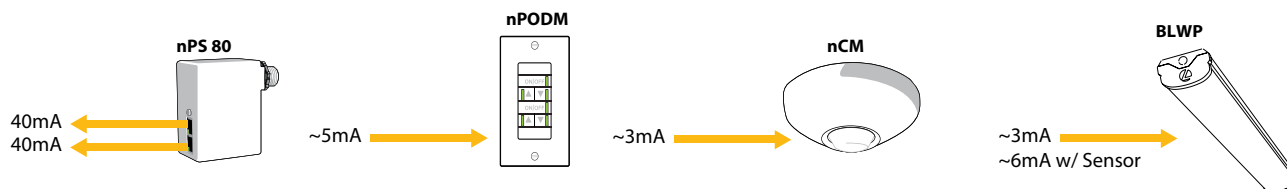
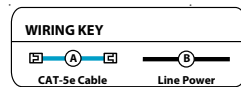
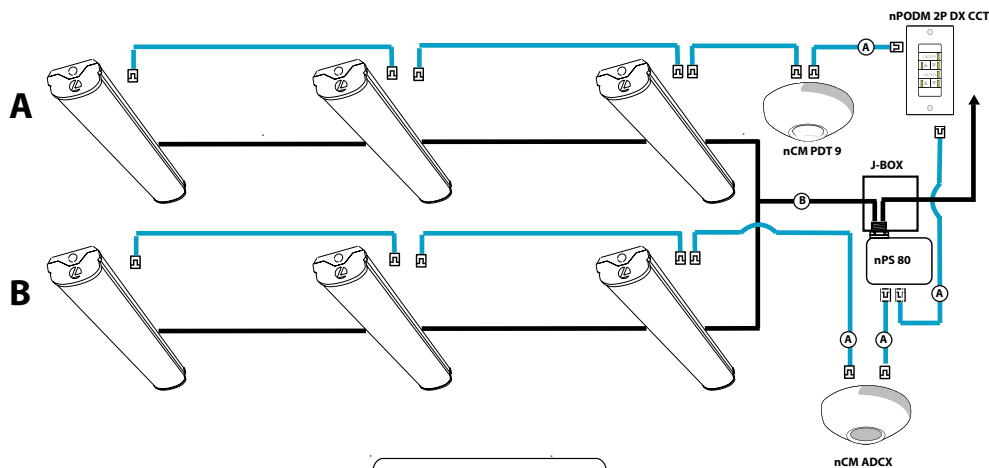

# BLWP Tunable White Low Profile LED Wraparound

Sensor Options				
Option	Automatic Dimming Photocell	Occupancy Sensing		nLight Wired Networking
		PIR	PDT	
NES7		X		X
NES7ADCX	X	X		X
NESPDT7			X	X
NESPDT7ADCX	X		X	X

\*Requires network to be present for sensors to operate

## nLight Wired Networking

The nES 7 is ideal for small rooms without obstructions or areas with primarily walking motion. Ideal areas include hallways, corridors, storage rooms, and breakrooms. Additionally, the NES7ADCX includes an integrated photocell, which enables daylight harvesting controls.

For areas like restrooms, private offices, open offices, conference rooms or any space with obstructions, the nES PDT 7 dual technology sensor is recommended. The nES PDT 7 utilizes both PIR (passive infrared) and Microphonics technologies to detect occupancy. Additionally, the NESPDT7ADCX includes an integrated photocell, which enables daylight harvesting controls which is ideal for areas where windows are present.

## Sequence of Operation

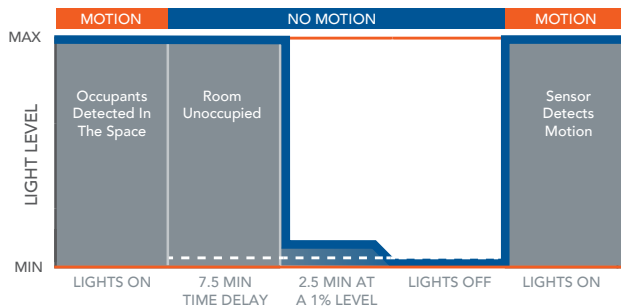

\*The presetting on the automatic dimming photocell is 5fc.

## Sensor Coverage Pattern Mini 360° Lens

- Recommended for walking motion detection from mounting heights between 8 ft (2.44 m) and 20 ft (6.10 m)
- Initial detection of walking motion along sensor axes at distances of 2x the mounting height up to 15 ft (4.57 m) and 1.75x up to 20 ft (6.10 m).
- Provides 12 ft (3.66 m) radial detection of small motion when mounted at 9 ft (2.74 m)
- Initial detection will occur earlier when walking across sensor's field of view than when walking directly at sensor

## 9 FT Mounting

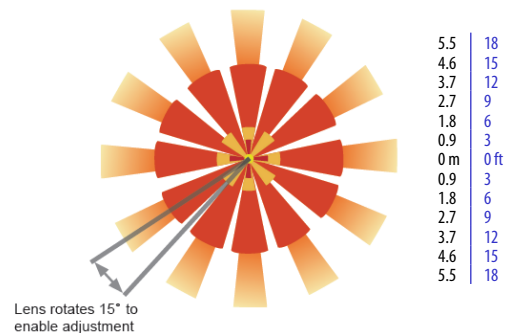

# BLWP Tunable White Low Profile LED Wraparound

## MOUNTING INFORMATION

For unit or row installation; surface or suspend mounting.

### Suspension Methods:

#### Aircraft Cable Suspension

Order one BLWPCG\_, BLWPCGF\_, or BLWPCGE\_ required for each suspension point.  
F1 for use with most T-bar and screw slot grid ceiling applications. Designed for on-grid and off-grid installations.

F2 for use with recessed or surface-mount horizontal J-box applications.

See Accessories page on page 3 for part numbers configurations.



#### Stem Suspension

Individual installation — Two single-stem hangers required.

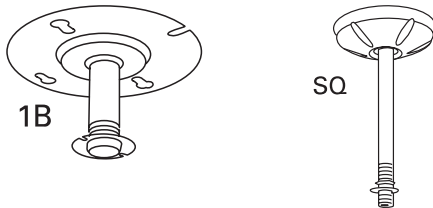

Note: 2' configurations with emergency option cannot be stem mounted.

### Accessory Images

#### (QMB) Quick Mount Bracket

Quick Mount Bracket allows easy installation to junction boxes without having to remove any parts in the fixture.

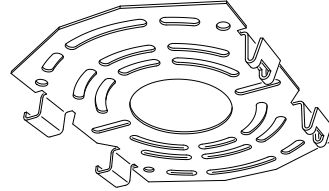

Note: 2' configurations not available with QMB accessory.

#### BLWPCR - continuous row mount bracket

Order one (1) BLWPCR bracket per fixture for continuous row applications. Order one hanger(Aircraft Cable Suspension Kit or Stem Suspension Kit) per fixture plus one per joiner required.

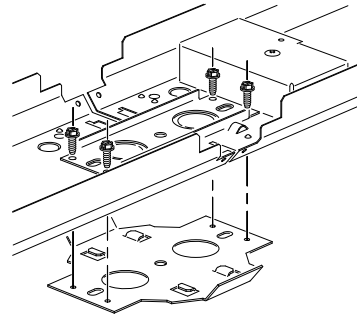

## DIMENSIONS

All dimensions are inches (centimeters) unless otherwise noted.

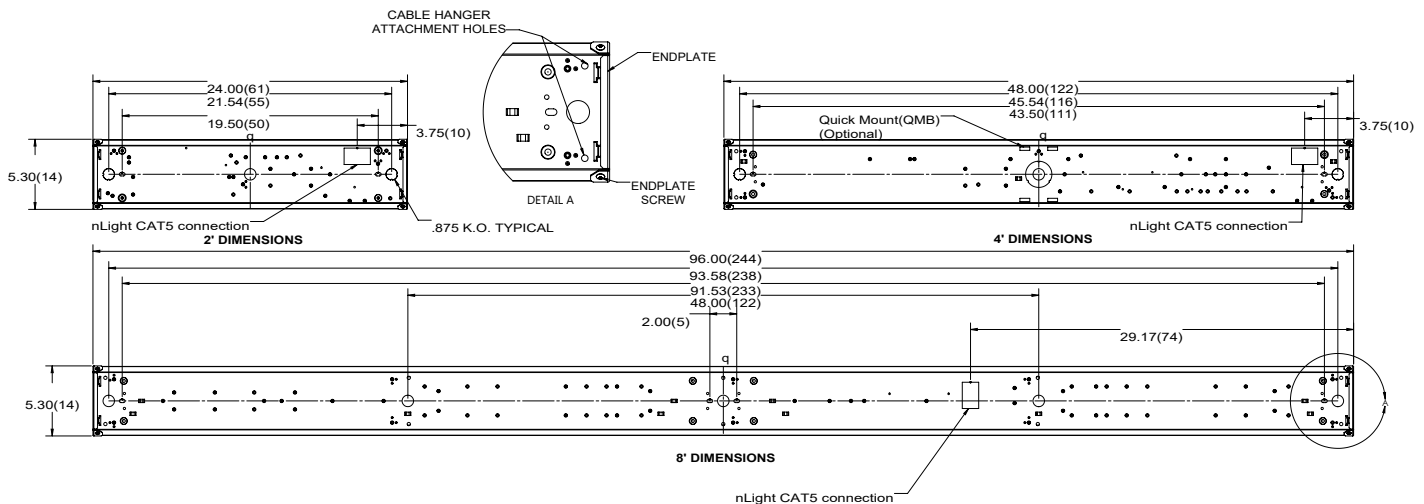

# BLWP Tunable White Low Profile LED Wraparound

## PHOTOMETRICS

**BLWP4 TUWH PROR 40L ADP NLT - 3000K 80CRI**, 3755 delivered lumens, test no. ISF 183669, tested in accordance to IESNA LM-79.

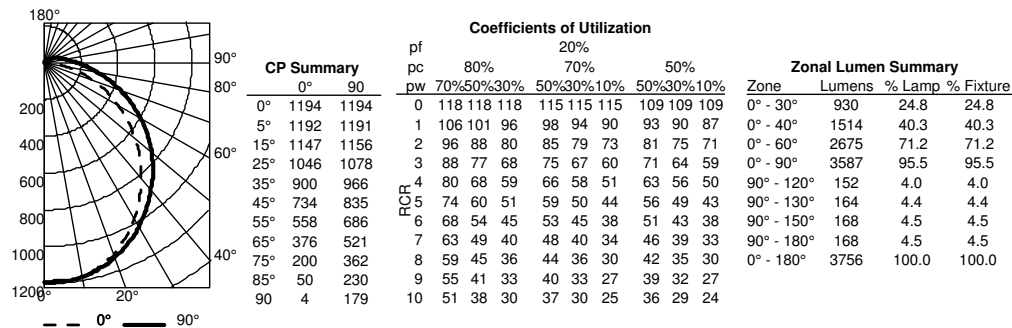

**BLWP4 TUWH PROR 40L ADP NLT - 4000K 80CRI**, 3436 delivered lumens, test no. ISF 183670, tested in accordance to IESNA LM-79.

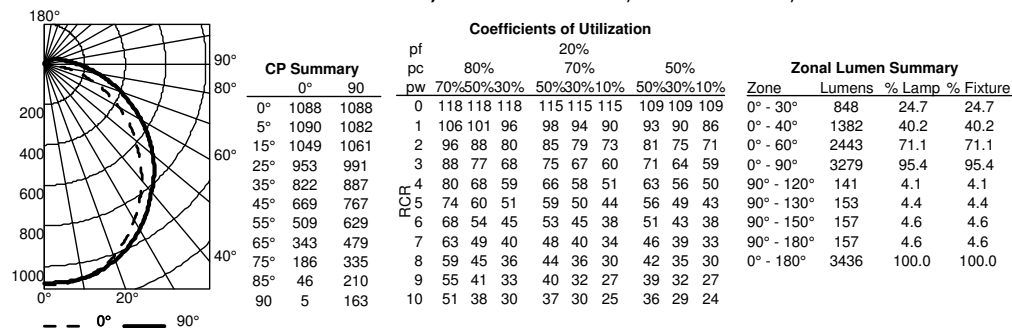

**BLWP4 TUWH PROR 40L ADP NLT - 5000K 80CRI**, 3762 delivered lumens, test no. ISF 183671, tested in accordance to IESNA LM-79.

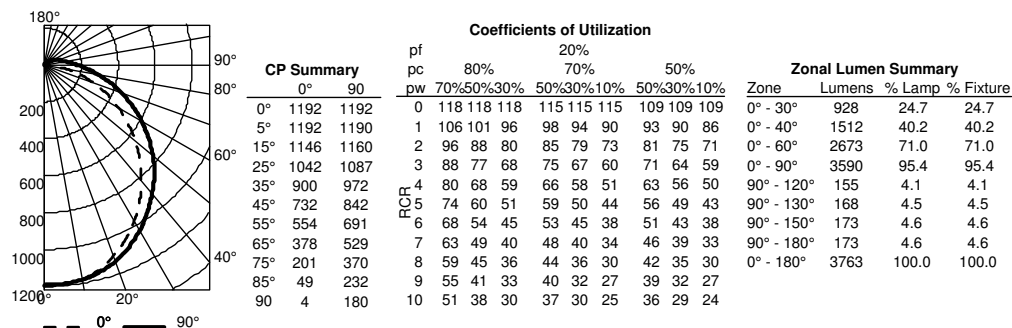



# BLWP Tunable White Low Profile LED Wraparound

## LUMEN OUTPUT

Fixture size	Lumen package	BLWP TUWH RHYR LUMEN OUTPUT PER CCT LENS: ADP CRI:80								BLWP TUWH PROR LUMEN OUTPUT PER CCT LENS: ADP CRI:80					
		2700K	3000K	3500K	4000K	4500K	5000K	5700K	6500K	3000K	3500K	4000K	4500K	5000K	
BLWP2	800	1054	1056	1060	1062	1062	1062	1059	1052		1098	1044	1018	1021	1053
	2000	1990	1988	1989	1989	1992	1993	1998	2004		2061	1969	1934	1951	2023
	3300	3215	3216	3224	3234	3248	3261	3279	3299		3340	3282	3269	3290	3348
	4000	4302	4257	4200	4167	4157	4171	4229	4352		3982	3967	3977	4004	4050
BLWP4	1500	1583	1581	1581	1579	1581	1581	1585	1588		1519	1442	1410	1424	1479
	2000	2065	2060	2057	2055	2058	2063	2074	2091		2036	1941	1905	1923	1996
	3000	2970	2967	2967	2970	2978	2987	3002	3024		3044	2964	2939	2960	3029
	4000	3888	3890	3899	3914	3932	3950	3979	4014		3962	3933	3938	3966	4019
	4800	4933	4933	4938	4950	4968	4994	5042	5113		4655	4691	4728	4762	4792
	6000	5924	5967	6029	6079	6117	6143	6161	6152		5686	5627	5621	5665	5762
BLWP8	4000	4131	4065	3980	3921	3892	3892	3942	4068		4186	3904	3790	3839	4051
	6000	6143	6031	5883	5786	5743	5752	5855	6102		6206	5884	5754	5815	6065
	8000	8037	7910	7742	7635	7590	7612	7755	8079		8102	7822	7710	7775	8014
	10000	9966	9882	9770	9705	9688	9729	9880	10184		10054	9945	9912	9980	10144
	14000	13519	13528	13546	13567	13591	13618	13662	13719		14104	14028	13998	14015	14078

# BLWP Tunable White Low Profile LED Wraparound

## INPUT WATTS

Fixture size	Lumen package	BLWP TUWH RHYR POWER OUTPUT LENS: ADP CRI:80								BLWP TUWH PROR POWER OUTPUT LENS: ADP CRI:80					
		2700K	3000K	3500K	4000K	4500K	5000K	5700K	6500K	3000K	3500K	4000K	4500K	5000K	
BLWP2	800	9.70	9.70	9.70	9.68	9.76	9.60	9.50	9.36		9.48	9.11	8.89	8.83	8.91
	2000	17.70	17.43	17.04	16.74	16.68	16.43	16.44	16.66		17.09	15.92	15.32	15.31	15.88
	3300	30.25	29.30	28.00	27.05	26.61	26.28	26.64	27.92		29.19	26.30	24.93	25.11	26.81
	4000	38.23	36.40	33.92	32.15	31.10	30.76	31.48	34.02		36.57	32.56	30.67	30.97	33.40
BLWP4	1500	13.44	13.32	13.15	13.01	13.03	12.83	12.78	12.79		12.44	11.77	11.41	11.37	11.64
	2000	17.50	17.22	16.83	16.54	16.48	16.25	16.29	16.56		16.54	15.42	14.84	14.83	15.37
	3000	26.12	25.41	24.42	23.69	23.37	23.06	23.28	24.16		25.48	23.12	21.98	22.11	23.47
	4000	36.20	34.82	32.93	31.57	30.87	30.50	31.07	33.00		35.01	31.19	29.40	29.69	32.02
	4800	44.92	42.87	40.10	38.12	36.93	36.54	37.33	40.13		43.53	38.29	35.84	36.22	39.39
	6000	55.48	52.97	49.56	47.11	45.61	45.08	45.95	49.25		52.90	45.70	42.40	42.99	47.49
BLWP8	4000	31.76	30.58	28.97	27.80	27.19	26.85	27.28	28.86		31.25	27.86	26.26	26.50	28.53
	6000	50.30	47.58	43.92	41.34	39.82	39.45	40.71	44.76		48.85	42.34	39.35	39.86	43.89
	8000	70.35	65.75	59.64	55.42	52.79	52.49	54.78	61.93		68.20	57.64	52.89	53.85	60.59
	10000	91.49	84.98	76.40	70.55	66.81	66.68	70.14	80.64		89.28	74.44	67.91	69.45	79.24
	14000	127.09	118.96	108.18	100.86	96.08	96.62	101.89	116.23		124.47	104.95	96.46	99.00	112.57

## LUMENS PER WATT (LPW)

Fixture size	Lumen package	BLWP TUWH RHYR LPW LENS: ADP CRI:80								BLWP TUWH PROR LPW LENS: ADP CRI:80					
		2700K	3000K	3500K	4000K	4500K	5000K	5700K	6500K	3000K	3500K	4000K	4500K	5000K	
BLWP2	800	108.65	108.87	109.26	109.68	108.90	110.65	111.43	112.44		115.83	114.55	114.48	115.71	118.20
	2000	112.42	114.07	116.70	118.80	119.43	121.33	121.55	120.30		120.60	123.72	126.28	127.45	127.38
	3300	106.28	109.75	115.14	119.57	122.02	124.08	123.06	118.17		114.43	124.78	131.13	131.03	124.89
	4000	112.53	116.95	123.84	129.61	133.69	135.61	134.35	127.92		108.89	121.84	129.66	129.31	121.26
BLWP4	1500	117.78	118.68	120.20	121.39	121.37	123.27	124.07	124.17		122.11	122.55	123.62	125.23	127.11
	2000	117.99	119.62	122.18	124.25	124.87	126.96	127.31	126.24		123.10	125.91	128.35	129.70	129.89
	3000	113.70	116.77	121.52	125.39	127.40	129.55	128.97	125.17		119.47	128.24	133.70	133.90	129.08
	4000	107.40	111.71	118.42	123.99	127.38	129.52	128.04	121.63		113.17	126.11	133.93	133.57	125.51
	4800	109.82	115.05	123.14	129.85	134.53	136.68	135.08	127.41		106.94	122.51	131.92	131.48	121.66
	6000	106.78	112.64	121.65	129.04	134.10	136.27	134.07	124.91		107.49	123.14	132.56	131.76	121.32
BLWP8	4000	130.06	132.93	137.38	141.07	143.17	144.99	144.50	140.98		133.95	140.12	144.31	144.91	141.99
	6000	122.12	126.75	133.96	139.95	144.23	145.79	143.82	136.31		127.04	138.96	146.24	145.88	138.19
	8000	114.24	120.30	129.81	137.76	143.77	145.02	141.57	130.46		118.80	135.71	145.77	144.38	132.26
	10000	108.93	116.28	127.89	137.57	145.02	145.90	140.86	126.30		112.61	133.59	145.97	143.70	128.02
	14000	106.37	113.72	125.21	134.50	141.45	140.94	134.08	118.04		113.31	133.66	145.11	141.56	125.06