



D-Series Size 2 LED Area Luminaire



d#series

Specifications

EPA:	1.06 ft ² (0.10 m ²)
Length:	40.59" (103.1 cm)
Width:	16.76" (42.6 cm)
Height H1:	8.11" (20.6 cm)
Height H2:	3.96" (10.1 cm)
Weight:	46 lbs (20.9 kg)

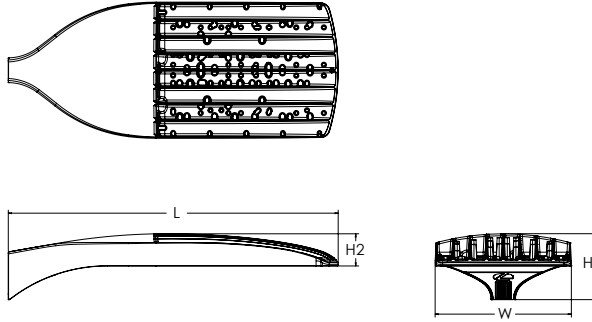

Catalog
Number

Notes

Type

Hit the Tab key or mouse over the page to see all interactive elements.

Introduction

The modern styling of the D-Series features a highly refined aesthetic that blends seamlessly with its environment. The D-Series offers the benefits of the latest in LED technology into a high performance, high efficacy, long-life luminaire.

The outstanding photometric performance results in sites with excellent uniformity, greater pole spacing and lower power density. D-Series outstanding photometry aids in reducing the number of poles required in area lighting applications with typical energy savings of up to 80% vs. 1000W HID and expected service life of over 100,000 hours.

Ordering Information

EXAMPLE: DSX2 LED P7 40K 70CRI T3M MVOLT SPA NLTAIR2 PIRHN DDBXD

DSX2 LED	Series	LEDs	Color temperature ²	Color Rendering Index ²	Distribution	Voltage	Mounting	
DSX2 LED	Forward optics	P1 P5	30K 3000K	70CRI	AFR Automotive front row	T5M Type V medium	MVOLT (120V-277V) ⁴ HVOLT (347V-480V) ^{5,6} XVOLT (277V - 480V) ^{7,8}	Shipped included SPA Square pole mounting (#8 drilling) RPA Round pole mounting (#8 drilling) SPA5 Square pole mounting #5 drilling ⁹ RPA5 Round pole mounting #5 drilling ⁹ SPA8N Square narrow pole mounting #8 drilling WBA Wall bracket ¹⁰ MA Mast arm adapter (mounts on 2 3/8" OD horizontal tenon)
		P2 P6	40K 4000K	70CRI	T1S Type I short	T5LG Type V low glare		
		P3 P7	50K 5000K	70CRI	T2M Type II medium	T5W Type V wide		
		P4 P8	(this section 80CRI only, extended lead times apply)		T3M Type III medium	BLC3 Type III backlight control ³		
		P10 ¹ P13 ¹	27K 2700K	80CRI	T3LG Type III low glare ³	BLC4 Type IV backlight control ³		
		P11 ¹ P14 ¹	30K 3000K	80CRI	T4M Type IV medium	LCCO Left corner cutoff ³		
		P12 ¹	35K 3500K	80CRI	T4LG Type IV low glare ³	RCCO Right corner cutoff ³		
			40K 4000K	80CRI	TFTM Forward throw medium			
		50K 5000K	80CRI					

Control options	Other options	Finish (required)
Shipped installed NLTAIR2 PIRHN nLight AIR gen 2 enabled with bi-level motion / ambient senso, 8-40' mounting height, ambient sensor enabled at 2fc. ^{11, 12, 20, 21} PIR High/low, motion/ambient sensor, 8-40' mounting height, ambient sensor enabled at 2fc. ^{13, 20, 21} PER NEMA twist-lock receptacle only (controls ordered separate) ¹⁴ PERS Five-pin receptacle only (controls ordered separate) ^{14, 21}	PER7 Seven-pin receptacle only (controls ordered separate) ^{14, 21} FAO Field adjustable output ^{15, 21} BL30 Bi-level switched dimming, 30% ^{16, 21} BL50 Bi-level switched dimming, 50% ^{16, 21} DMG 0-10v dimming wires pulled outside fixture (for use with an external control, ordered separately) ¹⁷ DS Dual switching ^{18, 19, 21}	Shipped installed SPD20KV 20KV surge protection HS Houseside shield (black finish standard) ²² L90 Left rotated optics ¹ R90 Right rotated optics ¹ CCE Coastal Construction ²³ HA 50°C ambient operation ²⁴ Shipped separately EGSR External Glare Shield (reversible, field install required, matches housing finish) BSDB Bird Spikes (field install required)
		DDBXD Dark Bronze DBLXD Black DNAXD Natural Aluminum DWHXD White DDBTXD Textured dark bronze DBLTXD Textured black DNATXD Textured natural aluminum DWHGXD Textured white



Ordering Information

Accessories

Ordered and shipped separately.

DLL127F 1.5 JU	Photocell - SSL twist-lock (120-277V) ²⁵
DLL347F 1.5 CUL JU	Photocell - SSL twist-lock (347V) ²⁵
DLL480F 1.5 CUL JU	Photocell - SSL twist-lock (480V) ²⁵
DSHORT SBK	Shorting cap ²⁵
DSX2HS P#	House-side shield (enter package number 1-13 in place of #)
DSXRPA (FINISH)	Round pole adapter (#8 drilling, specify finish)
DSXSPA5 (FINISH)	Square pole adapter #5 drilling (specify finish)
DSXRPAS (FINISH)	Round pole adapter #5 drilling (specify finish)
DSX1EGSR (FINISH)	External glare shield (specify finish)
DSX2B5DB (FINISH)	Bird spike deterrent bracket (specify finish)

NOTES

- Rotated optics available with packages P10, P11, P12, P13 and P14. Must be combined with option L90 or R90.
- 30K, 40K, and 50K available in 70CRI and 80CRI. 27K and 35K only available with 80CRI. Contact Technical Support for other possible combinations.
- T3LG, T4LG, BLC3, BLC4, LCCO, RCCO not available with option HS.
- HVOLT driver operates on any line voltage from 120-277V (50/60 Hz).
- HVOLT driver operates on any line voltage from 347-480V (50/60 Hz).
- HVOLT not available with package P10 when combined with option NLTAIR2 PIRHN or option PIR.
- XVOLT operates with any voltage between 277V and 480V (50/60 Hz).
- XVOLT not available in package P10.
- SPA5 and RPA5 for use with #5 drilling only (Not for use with #8 drilling).
- WBA cannot be combined with Type 5 distributions plus photocell (PER).
- NLTAIR2 and PIRHN must be ordered together. For more information on nLight AIR2 visit this [link](#).
- NLTAIR2 PIRHN not available with other controls including PIR, PER, PER5, PER7, FAO, BL30, BL50, DMG and DS. NLTAIR2 PIRHN not available with P10 using HVOLT. NLTAIR2 PIRHN not available with P10 using XVOLT.
- PIR not available with NLTAIR2 PIRHN, PER, PER5, PER7, FAO BL30, BL50, DMG and DS. PIR not available with P10 using HVOLT. PIR not available with P10 using XVOLT.
- PER/PER5/PER7 not available with NLTAIR2 PIRHN, PIR, BL30, BL50, FAO, DMG and DS. Photocell ordered and shipped as a separate line item from Acuity Brands Controls. See accessories. Shorting Cap included.
- FAO not available with other dimming control options NLTAIR2 PIRHN, PIR, PER5, PER7, BL30, BL50, DMG and DS.
- BL30 and BL50 are not available with NLTAIR2 PIRHN, PIR, PER, PER5, PER7, FAO, DMG and DS.
- DMG not available with NLTAIR2 PIRHN, PIR, PER, PER5, PER7, BL30, BL50, FAO and DS.
- DS not available with NLTAIR2 PIRHN, PIR, PER, PER5, PER7, BL30, BL50, FAO and DMG.
- DS requires (2) separately switched circuits. DS provides 50/50 fixture operation via (2) different sets of leads on P1, P2, P3, P4, P5 (2 drivers). Note: Provides 60/40 operation using (2) different sets of leads on P6, P7, P8, P9, P10, P11, P12, P13, P14 (3 drivers).
- Reference Motion Sensor Default Settings table on page 4 to see functionality.
- Reference Controls Options table on page 4.
- HS not available with T3LG, T4LG, BLC3, BLC4, LCCO and RCCO distribution. Also available as a separate accessory; see Accessories information.
- CCE option not available with option B5 and EGSR. Contact Technical Support for availability.
- Option HA not available with performance packages P5, P6, P7, P8, P13 and P14.
- 25 Reference luminaire to be specified with PER, PER5 or PER7 option. See Controls Table on page 4.

Shield Accessories



External Glare Shield (EGSR)

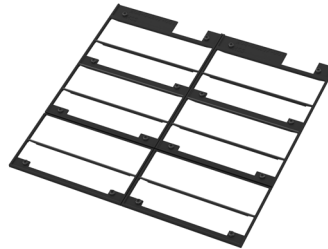

House Side Shield (HS)

Drilling

HANDHOLE ORIENTATION

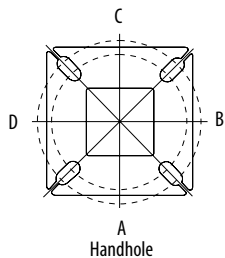

Handhole

Template #8

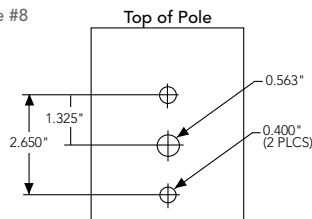

Tenon Mounting Slipfitter

Tenon O.D.	Mounting	Single Unit	2 @ 180	2 @ 90	3 @ 90	3 @ 120	4 @ 90
2-3/8"	RPA	AS3-5 190	AS3-5 280	AS3-5 290	AS3-5 390	AS3-5 320	AS3-5 490
2-7/8"	RPA	AST25-190	AST25-280	AST25-290	AST25-390	AST25-320	AST25-490
4"	RPA	AST35-190	AST35-280	AST35-290	AST35-390	AST35-320	AST35-490

Mounting Option	Drilling Template	Single	2 @ 180	2 @ 90	3 @ 90	3 @ 120	4 @ 90
Head Location		Side B	Side B & D	Side B & C	Side B, C & D	Round Pole Only	Side A, B, C & D
Drill Nomenclature	#8	DM19AS	DM28AS	DM29AS	DM39AS	DM32AS	DM49AS
Minimum Acceptable Outside Pole Dimension							
SPA	#8	3.5"	3.5"	3.5"	3.5"	3"	3.5"
RPA	#8	3"	3"	3"	3"	3"	3"
SPA5	#5	3"	3"	3"	3"	3"	3"
RPA5	#5	3"	3"	3"	3"	3"	3"
SPA8N	#8	3"	3"	3"	3"	3"	3"

DSX2 Area Luminaire - EPA

*Includes luminaire and integral mounting arm. Other tenons, arms, brackets or other accessories are not included in this EPA data.

Fixture Quantity & Mounting Configuration	Single DM19	2 @ 180 DM28	2 @ 90 DM29	3 @ 90 DM39	3 @ 120 DM32	4 @ 90 DM49
Mounting Type						
DSX2 with SPA	1.06	2.12	1.84	2.32	---	2.33
DSX2 with SPA5, SPA8N	1.07	2.14	1.90	2.43	---	2.44
DSX2 with RPA, RPA5	1.07	2.14	1.90	2.43	2.31	2.44
DSX2 with MA	1.20	2.40	2.12	3.00	2.92	3.00

Photometric Diagrams

To see complete photometric reports or download .ies files for this product, visit Lithonia Lighting's [homepage](#).

Isofootcandle plots for the DSX2 LED P8 40K 70CRI. Distances are in units of mounting height (40').

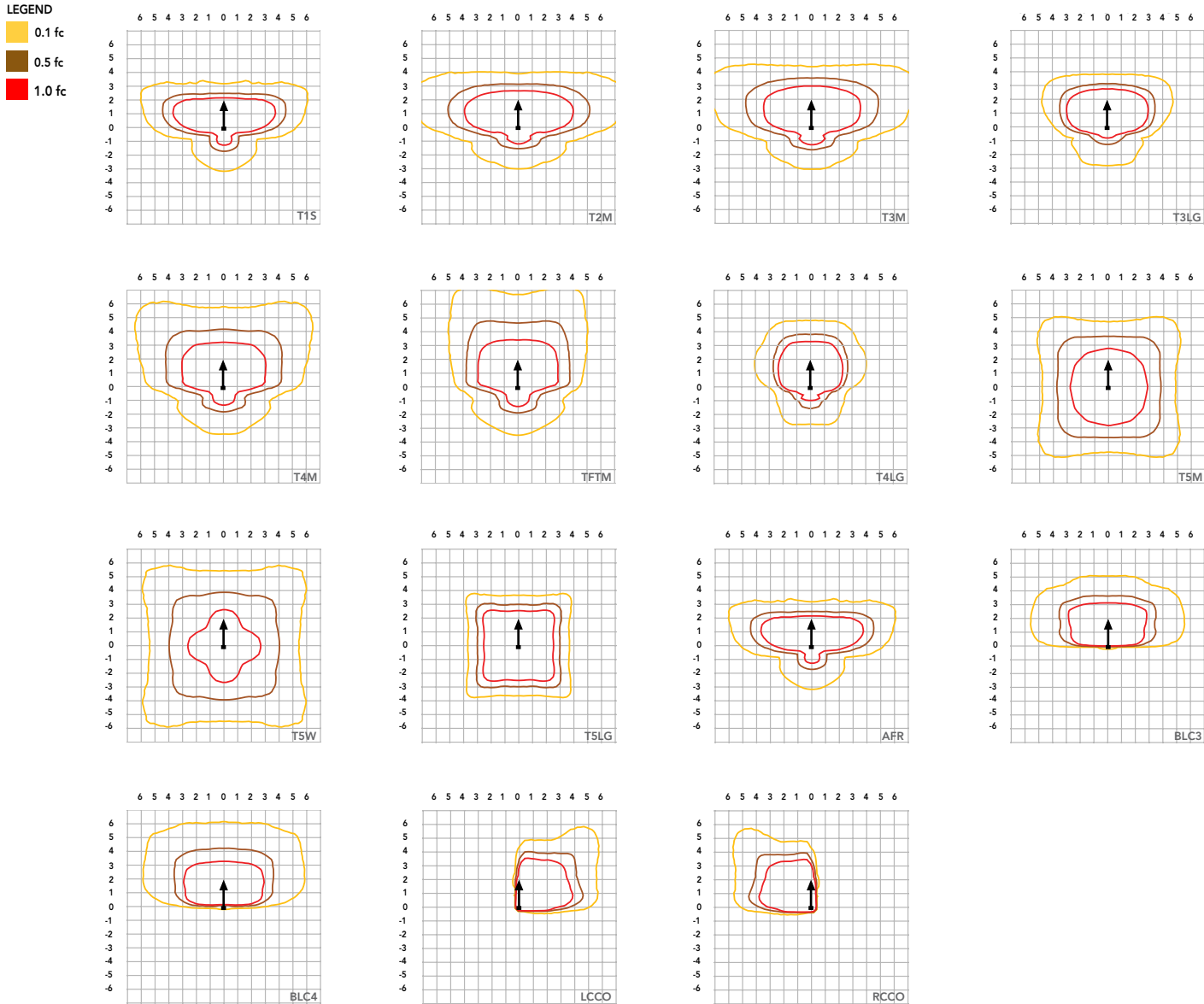

Performance Data

Lumen Ambient Temperature (LAT) Multipliers

Use these factors to determine relative lumen output for average ambient temperatures from 0-40°C (32-104°F).

Ambient		Lumen Multiplier
0°C	32°F	1.04
5°C	41°F	1.03
10°C	50°F	1.03
15°C	50°F	1.02
20°C	68°F	1.01
25°C	77°F	1.00
30°C	86°F	0.99
35°C	95°F	0.98
40°C	104°F	0.97

Projected LED Lumen Maintenance

Data references the extrapolated performance projections for the platforms noted in a **25°C ambient**, based on 10,000 hours of LED testing (tested per IESNA LM-80-08 and projected per IESNA TM-21-11).

To calculate LLF, use the lumen maintenance factor that corresponds to the desired number of operating hours below. For other lumen maintenance values, contact factory.

Operating Hours	Lumen Maintenance Factor
0	1.00
25,000	0.95
50,000	0.90
100,000	0.82

FAO Dimming Settings

FAO Position	% Wattage	% Lumen Output
8	100%	100%
7	93%	95%
6	80%	85%
5	66%	73%
4	54%	61%
3	41%	49%
2	29%	36%
1	15%	20%

*Note: Calculated values are based on original performance package data. When calculating new values for given FAO position, use published values for each package based on input watts and lumens by optic type.

Electrical Load

	Performance Package	LED Count	Drive Current (mA)	Wattage	Current (A)					
					120V	208V	240V	277V	347V	480V
Forward Optics (Non-Rotated)	P1	80	530	135	1.12	0.65	0.56	0.49	0.39	0.28
	P2	80	700	181	1.49	0.86	0.75	0.65	0.52	0.37
	P3	80	850	222	1.83	1.05	0.91	0.79	0.63	0.46
	P4	80	1050	277	2.27	1.31	1.14	0.98	0.79	0.57
	P5	80	1250	333	2.72	1.57	1.36	1.18	0.94	0.68
	P6	100	1050	345	2.85	1.64	1.42	1.23	0.98	0.71
	P7	100	1250	414	3.41	1.97	1.70	1.48	1.18	0.85
	P8	100	1400	466	3.85	2.22	1.93	1.67	1.33	0.96
Rotated Optics (Requires L90 or R90)	P10	90	530	152	1.27	0.73	0.63	0.55	0.44	0.32
	P11	90	700	203	1.69	0.97	0.84	0.73	0.58	0.42
	P12	90	850	249	2.06	1.19	1.03	0.89	0.71	0.52
	P13	90	1200	358	2.95	1.70	1.47	1.28	1.02	0.74
	P14	90	1400	421	3.46	2.00	1.73	1.50	1.20	0.87

LED Color Temperature / Color Rendering Multipliers

	70 CRI		80CRI		90CRI	
	Lumen Multiplier	Availability	Lumen Multiplier	Availability	Lumen Multiplier	Availability
5000K	102%	Standard	92%	Extended lead-time	71%	(see note)
4000K	100%	Standard	92%	Extended lead-time	67%	(see note)
3500K	100%	(see note)	90%	Extended lead-time	63%	(see note)
3000K	96%	Standard	87%	Extended lead-time	61%	(see note)
2700K	94%	(see note)	85%	Extended lead-time	57%	(see note)

Note: Some LED types are available as per special request. Contact Technical Support for more information.

Motion Sensor Default Settings

Option	Unoccupied Dimmed Level	High Level (when occupied)	Photocell Operation	Dwell Time	Ramp-up Time	Dimming Fade Rate
PIR	30%	100%	Enabled @ 2FC	7.5 min	3 sec	5 min
PIRHN	30%	100%	Enabled @ 2FC	7.5 min	3 sec	5 min

Controls Options

Nomenclature	Description	Functionality	Primary control device	Notes
FAO	Field adjustable output device installed inside the luminaire; wired to the driver dimming leads.	Allows the luminaire to be manually dimmed, effectively trimming the light output.	FAO device	Cannot be used with other controls options that need the 0-10V leads
DS (not available on DSX0)	Drivers wired independently for 50/50 luminaire operation	The luminaire is wired to two separate circuits, allowing for 50/50 operation.	Independently wired drivers	Requires two separately switched circuits. Consider nLight AIR as a more cost effective alternative.
PERS or PER7	Twist-lock photocell receptacle	Compatible with standard twist-lock photocells for dusk to dawn operation, or advanced control nodes that provide 0-10V dimming signals.	Twist-lock photocells such as DLL Elite or advanced control nodes such as ROAM.	Pins 4 & 5 to dimming leads on driver, Pins 6 & 7 are capped inside luminaire. Cannot be used with other controls options that need the 0-10V leads.
PIR	Motion sensor with integral photocell. Sensor suitable for 8' to 40' mounting height.	Luminaires dim when no occupancy is detected.	Acuity Controls rSBG	Cannot be used with other controls options that need the 0-10V leads.
NLTAIR2 PIRHN	nLight AIR enabled luminaire for motion sensing, photocell and wireless communication.	Motion and ambient light sensing with group response. Scheduled dimming with motion sensor over-ride when wirelessly connected to the nLight Eclipse.	nLight Air rSBG	nLight AIR sensors can be programmed and commissioned from the ground using the CIAIRity Pro app. Cannot be used with other controls options that need the 0-10V leads.
BL30 or BL50	Integrated bi-level device that allows a second control circuit to switch all light engines to either 30% or 50% light output	BLC device provides input to 0-10V dimming leads on all drivers providing either 100% or dimmed (30% or 50%) control by a secondary circuit	BLC UVOLT1	BLC device is powered off the 0-10V dimming leads, thus can be used with any input voltage from 120 to 480V

Performance Data

Lumen Output

Lumen values are from photometric tests performed in accordance with IESNA LM-79-08. Data is considered to be representative of configurations shown within the tolerances described within LM-79. Contact factory for performance data on any configurations not shown here.

Forward Optics																							
Performance Package	System Watts	LED Count	Drive Current (mA)	Distribution Type	30K					40K					50K								
					(3000K, 70 CRI)					(4000K, 70 CRI)					(5000K, 70 CRI)								
					Lumens	B	U	G	LPW	Lumens	B	U	G	LPW	Lumens	B	U	G	LPW				
P1	135W	80	530	T1S	19,946	2	0	3	148	20,787	2	0	3	155	21,192	2	0	3	158				
				T2M	18,477	3	0	4	137	19,256	3	0	4	143	19,632	3	0	4	146				
				T3M	18,691	3	0	5	139	19,480	3	0	5	145	19,859	3	0	5	148				
				T3LG	16,696	2	0	2	124	17,400	2	0	2	129	17,740	2	0	2	132				
				T4M	18,970	3	0	5	141	19,770	3	0	5	147	20,155	3	0	5	150				
				T4LG	17,253	2	0	2	128	17,981	2	0	2	134	18,331	2	0	2	136				
				TFTM	19,101	3	0	5	142	19,907	3	0	5	148	20,295	3	0	5	151				
				T5M	19,517	5	0	3	145	20,341	5	0	3	151	20,737	5	0	3	154				
				T5W	19,834	5	0	3	147	20,670	5	0	3	154	21,073	5	0	3	157				
				T5LG	19,574	4	0	2	146	20,400	4	0	2	152	20,797	4	0	2	155				
				BLC3	13,595	0	0	3	101	14,169	0	0	3	105	14,445	0	0	3	107				
				BLC4	14,042	0	0	4	104	14,634	0	0	4	109	14,919	0	0	4	111				
				RCCO	13,718	1	0	3	102	14,297	1	0	3	106	14,576	1	0	3	108				
				LCCO	13,718	1	0	3	102	14,297	1	0	3	106	14,576	1	0	3	108				
				AFR	19,946	2	0	3	148	20,787	2	0	3	155	21,192	2	0	3	158				
				P2	179W	80	700	T1S	25,520	3	0	3	142	26,597	3	0	3	148	27,116	3	0	3	151
								T2M	23,641	3	0	5	132	24,638	3	0	5	137	25,118	3	0	5	140
T3M	23,915	3	0					5	133	24,924	3	0	5	139	25,410	3	0	5	142				
T3LG	21,363	3	0					3	119	22,264	3	0	3	124	22,698	3	0	3	127				
T4M	24,272	3	0					5	135	25,296	3	0	5	141	25,789	3	0	5	144				
T4LG	22,075	3	0					3	123	23,006	3	0	3	128	23,455	3	0	3	131				
TFTM	24,440	3	0					5	136	25,471	3	0	5	142	25,967	3	0	5	145				
T5M	24,972	5	0					3	139	26,026	5	0	3	145	26,533	5	0	4	148				
T5W	25,377	5	0					4	142	26,448	5	0	4	148	26,963	5	0	4	150				
T5LG	25,045	4	0					2	140	26,101	4	0	2	146	26,610	4	0	2	148				
BLC3	17,395	0	0					4	97	18,129	0	0	4	101	18,482	0	0	4	103				
BLC4	17,966	0	0					4	100	18,724	0	0	5	104	19,089	0	0	5	107				
RCCO	17,552	1	0					4	98	18,293	1	0	4	102	18,649	1	0	4	104				
LCCO	17,552	1	0					4	98	18,293	1	0	4	102	18,649	1	0	4	104				
AFR	25,520	3	0					3	142	26,597	3	0	3	148	27,116	3	0	3	151				
P3	219W	80	850					T1S	30,127	3	0	4	137	31,398	3	0	4	143	32,010	3	0	4	146
								T2M	27,908	3	0	5	127	29,085	3	0	5	133	29,652	3	0	5	135
				T3M	28,232	3	0	5	129	29,423	3	0	5	134	29,996	3	0	5	137				
				T3LG	25,218	3	0	3	115	26,282	3	0	3	120	26,794	3	0	3	122				
				T4M	28,652	3	0	5	131	29,861	3	0	5	136	30,443	3	0	5	139				
				T4LG	26,059	3	0	3	119	27,159	3	0	3	124	27,688	3	0	3	126				
				TFTM	28,851	3	0	5	132	30,068	3	0	5	137	30,654	3	0	5	140				
				T5M	29,479	5	0	4	134	30,723	5	0	4	140	31,322	5	0	4	143				
				T5W	29,957	5	0	4	137	31,221	5	0	4	142	31,830	5	0	4	145				
				T5LG	29,565	4	0	2	135	30,812	5	0	2	140	31,413	5	0	2	143				
				BLC3	20,535	0	0	4	94	21,401	0	0	4	98	21,818	0	0	4	99				
				BLC4	21,209	0	0	5	97	22,104	0	0	5	101	22,534	0	0	5	103				
				RCCO	20,720	1	0	4	94	21,594	1	0	4	98	22,015	1	0	4	100				
				LCCO	20,720	1	0	4	94	21,594	1	0	4	98	22,015	1	0	4	100				
				AFR	30,127	3	0	4	137	31,398	3	0	4	143	32,010	3	0	4	146				
				P4	273W	80	1050	T1S	35,879	3	0	4	132	37,392	3	0	4	137	38,121	3	0	4	140
								T2M	33,236	3	0	5	122	34,638	3	0	5	127	35,313	3	0	5	130
T3M	33,622	3	0					5	123	35,040	3	0	5	129	35,723	3	0	5	131				
T3LG	30,033	3	0					4	110	31,300	3	0	4	115	31,910	3	0	4	117				
T4M	34,123	3	0					5	125	35,562	3	0	5	130	36,255	3	0	5	133				
T4LG	31,035	3	0					4	114	32,344	3	0	4	119	32,974	3	0	4	121				
TFTM	34,359	3	0					5	126	35,808	3	0	5	131	36,506	3	0	5	134				
T5M	35,108	5	0					4	129	36,589	5	0	4	134	37,302	5	0	4	137				
T5W	35,677	5	0					4	131	37,182	5	0	5	136	37,907	5	0	5	139				
T5LG	35,209	5	0					3	129	36,695	5	0	3	135	37,410	5	0	3	137				
BLC3	24,456	0	0					4	90	25,487	0	0	4	93	25,984	0	0	5	95				
BLC4	25,258	0	0					5	93	26,324	0	0	5	97	26,837	0	0	5	98				
RCCO	24,676	1	0					4	91	25,717	1	0	4	94	26,218	1	0	4	96				
LCCO	24,676	1	0					4	91	25,717	1	0	4	94	26,218	1	0	4	96				
AFR	35,879	3	0					4	132	37,392	3	0	4	137	38,121	3	0	4	140				

Performance Data

Lumen Output

Lumen values are from photometric tests performed in accordance with IESNA LM-79-08. Data is considered to be representative of configurations shown within the tolerances described within LM-79. Contact factory for performance data on any configurations not shown here.

Forward Optics																							
Performance Package	System Watts	LED Count	Drive Current (mA)	Distribution Type	30K					40K					50K								
					(3000K, 70 CRI)					(4000K, 70 CRI)					(5000K, 70 CRI)								
					Lumens	B	U	G	LPW	Lumens	B	U	G	LPW	Lumens	B	U	G	LPW				
P5	327W	80	1250	T1S	41,149	3	0	4	126	42,885	3	0	4	131	43,721	3	0	4	134				
				T2M	38,118	4	0	5	117	39,727	4	0	5	122	40,501	4	0	5	124				
				T3M	38,561	3	0	5	118	40,187	3	0	5	123	40,971	3	0	5	125				
				T3LG	34,445	3	0	4	105	35,898	3	0	4	110	36,598	3	0	4	112				
				T4M	39,135	3	0	5	120	40,786	3	0	5	125	41,581	3	0	5	127				
				T4LG	35,594	3	0	4	109	37,095	3	0	4	114	37,818	3	0	4	116				
				TFTM	39,406	3	0	5	121	41,069	3	0	5	126	41,869	3	0	5	128				
				T5M	40,265	5	0	4	123	41,964	5	0	4	128	42,782	5	0	5	131				
				T5W	40,918	5	0	5	125	42,644	5	0	5	131	43,475	5	0	5	133				
				T5LG	40,382	5	0	3	124	42,085	5	0	3	129	42,906	5	0	3	131				
				BLC3	28,048	0	0	5	86	29,231	0	0	5	90	29,801	0	0	5	91				
				BLC4	28,969	0	0	5	89	30,191	0	0	5	92	30,779	0	0	5	94				
				RCCO	28,301	2	0	5	87	29,495	2	0	5	90	30,070	2	0	5	92				
				LCCO	28,301	2	0	5	87	29,495	2	0	5	90	30,070	2	0	5	92				
				AFR	41,149	3	0	4	126	42,885	3	0	4	131	43,721	3	0	4	134				
				P6	342W	100	1050	T1S	45,968	3	0	4	135	47,907	3	0	5	140	48,841	3	0	5	143
								T2M	42,582	4	0	5	125	44,379	4	0	5	130	45,244	4	0	5	132
T3M	43,076	4	0					5	126	44,894	4	0	5	131	45,769	4	0	5	134				
T3LG	38,479	3	0					4	113	40,102	3	0	4	117	40,884	3	0	4	120				
T4M	43,719	4	0					5	128	45,563	4	0	5	133	46,451	4	0	5	136				
T4LG	39,762	3	0					4	116	41,439	3	0	4	121	42,247	3	0	4	124				
TFTM	44,021	3	0					5	129	45,878	4	0	5	134	46,772	4	0	5	137				
T5M	44,980	5	0					5	132	46,878	5	0	5	137	47,792	5	0	5	140				
T5W	45,710	5	0					5	134	47,638	5	0	5	139	48,566	5	0	5	142				
T5LG	45,111	5	0					3	132	47,014	5	0	3	138	47,930	5	0	3	140				
BLC3	31,333	0	0					5	92	32,655	0	0	5	96	33,291	0	0	5	97				
BLC4	32,361	0	0					5	95	33,726	0	0	5	99	34,384	0	0	5	101				
RCCO	31,615	2	0					5	93	32,949	2	0	5	96	33,591	2	0	5	98				
LCCO	31,615	2	0					5	93	32,949	2	0	5	96	33,591	2	0	5	98				
AFR	45,968	3	0					4	135	47,907	3	0	5	140	48,841	3	0	5	143				
P7	409W	100	1250					T1S	52,692	3	0	5	129	54,915	3	0	5	134	55,986	3	0	5	137
								T2M	48,811	4	0	5	119	50,871	4	0	5	124	51,862	4	0	5	127
				T3M	49,378	4	0	5	121	51,461	4	0	5	126	52,464	4	0	5	128				
				T3LG	44,107	3	0	4	108	45,968	3	0	4	112	46,864	3	0	5	115				
				T4M	50,114	4	0	5	122	52,228	4	0	5	128	53,246	4	0	5	130				
				T4LG	45,579	3	0	4	111	47,501	3	0	4	116	48,427	3	0	4	118				
				TFTM	50,460	4	0	5	123	52,589	4	0	5	129	53,614	4	0	5	131				
				T5M	51,560	5	0	5	126	53,735	5	0	5	131	54,783	5	0	5	134				
				T5W	52,396	5	0	5	128	54,607	5	0	5	133	55,671	5	0	5	136				
				T5LG	51,710	5	0	4	126	53,891	5	0	4	132	54,941	5	0	4	134				
				BLC3	35,916	1	0	5	88	37,431	1	0	5	91	38,161	1	0	5	93				
				BLC4	37,095	0	0	5	91	38,660	0	0	5	94	39,413	0	0	5	96				
				RCCO	36,240	2	0	5	89	37,769	2	0	5	92	38,505	2	0	5	94				
				LCCO	36,240	2	0	5	89	37,769	2	0	5	92	38,505	2	0	5	94				
				AFR	52,692	3	0	5	129	54,915	3	0	5	134	55,986	3	0	5	137				
				P8	462W	100	1400	T1S	57,662	3	0	5	125	60,094	4	0	5	130	61,266	4	0	5	132
								T2M	53,415	4	0	5	116	55,668	4	0	5	120	56,753	4	0	5	123
T3M	54,034	4	0					5	117	56,314	4	0	5	122	57,412	4	0	5	124				
T3LG	48,267	3	0					5	104	50,304	3	0	5	109	51,284	4	0	5	111				
T4M	54,840	4	0					5	119	57,154	4	0	5	124	58,268	4	0	5	126				
T4LG	49,877	3	0					5	108	51,981	3	0	5	112	52,994	3	0	5	115				
TFTM	55,219	4	0					5	119	57,549	4	0	5	124	58,671	4	0	5	127				
T5M	56,423	5	0					5	122	58,803	5	0	5	127	59,949	5	0	5	130				
T5W	57,338	5	0					5	124	59,757	5	0	5	129	60,921	5	0	5	132				
T5LG	56,586	5	0					4	122	58,974	5	0	4	128	60,123	5	0	4	130				
BLC3	39,303	1	0					5	85	40,962	1	0	5	89	41,760	1	0	5	90				
BLC4	40,593	0	0					5	88	42,306	0	0	5	91	43,130	0	0	5	93				
RCCO	39,658	2	0					5	86	41,331	2	0	5	89	42,137	2	0	5	91				
LCCO	39,658	2	0					5	86	41,331	2	0	5	89	42,137	2	0	5	91				
AFR	57,662	3	0					5	125	60,094	4	0	5	130	61,266	4	0	5	132				

Performance Data

Lumen Output

Lumen values are from photometric tests performed in accordance with IESNA LM-79-08. Data is considered to be representative of configurations shown within the tolerances described within LM-79. Contact factory for performance data on any configurations not shown here.

Rotated Optics																							
Performance Package	System Watts	LED Count	Drive Current (mA)	Distribution Type	30K					40K					50K								
					(3000K, 70 CRI)					(4000K, 70 CRI)					(5000K, 70 CRI)								
					Lumens	B	U	G	LPW	Lumens	B	U	G	LPW	Lumens	B	U	G	LPW				
P10	152W	90	530	T1S	22,798	4	0	4	150	23,760	4	0	4	156	24,223	4	0	4	159				
				T2M	21,119	5	0	5	139	22,010	5	0	5	145	22,439	5	0	5	148				
				T3M	21,361	5	0	5	141	22,262	5	0	5	147	22,696	5	0	5	149				
				T3LG	19,084	4	0	4	126	19,889	4	0	4	131	20,277	4	0	4	133				
				T4M	21,679	5	0	5	143	22,594	5	0	5	149	23,034	5	0	5	152				
				T4LG	19,717	4	0	4	130	20,549	4	0	4	135	20,950	4	0	4	138				
				TFTM	21,833	5	0	5	144	22,754	5	0	5	150	23,197	5	0	5	153				
				T5M	22,305	5	0	3	147	23,246	5	0	3	153	23,699	5	0	3	156				
				T5W	22,667	5	0	3	149	23,623	5	0	4	155	24,084	5	0	4	158				
				T5LG	22,370	4	0	2	147	23,314	4	0	2	153	23,768	4	0	2	156				
				BLC3	15,539	4	0	4	102	16,194	4	0	4	107	16,510	4	0	4	109				
				BLC4	16,048	4	0	4	106	16,725	4	0	4	110	17,051	4	0	4	112				
				RCCO	15,679	1	0	3	103	16,340	1	0	3	108	16,659	1	0	3	110				
				LCCO	15,679	1	0	3	103	16,340	1	0	3	108	16,659	1	0	3	110				
				AFR	22,798	4	0	4	150	23,760	4	0	4	156	24,223	4	0	4	159				
				P11	203W	90	700	T1S	29,222	4	0	4	144	30,455	4	0	4	150	31,048	4	0	4	153
								T2M	27,070	5	0	5	134	28,212	5	0	5	139	28,762	5	0	5	142
T3M	27,380	5	0					5	135	28,535	5	0	5	141	29,091	5	0	5	144				
T3LG	24,462	4	0					4	121	25,493	4	0	4	126	25,990	4	0	4	128				
T4M	27,788	5	0					5	137	28,960	5	0	5	143	29,525	5	0	5	146				
T4LG	25,273	4	0					4	125	26,339	4	0	4	130	26,853	4	0	4	133				
TFTM	27,985	5	0					5	138	29,165	5	0	5	144	29,734	5	0	5	147				
T5M	28,591	5	0					4	141	29,797	5	0	4	147	30,377	5	0	4	150				
T5W	29,054	5	0					4	143	30,280	5	0	4	149	30,870	5	0	4	152				
T5LG	28,673	4	0					2	142	29,883	4	0	2	148	30,465	5	0	2	150				
BLC3	19,917	4	0					4	98	20,757	4	0	4	102	21,162	4	0	4	104				
BLC4	20,570	5	0					5	102	21,437	5	0	5	106	21,855	5	0	5	108				
RCCO	20,097	1	0					4	99	20,945	1	0	4	103	21,353	1	0	4	105				
LCCO	20,097	1	0					4	99	20,945	1	0	4	103	21,353	1	0	4	105				
AFR	29,222	4	0					4	144	30,455	4	0	4	150	31,048	4	0	4	153				
P12	248W	90	850					T1S	34,526	5	0	5	139	35,983	5	0	5	145	36,684	5	0	5	148
								T2M	31,984	5	0	5	129	33,333	5	0	5	135	33,983	5	0	5	137
				T3M	32,350	5	0	5	131	33,715	5	0	5	136	34,372	5	0	5	139				
				T3LG	28,902	4	0	4	117	30,121	4	0	4	122	30,708	4	0	4	124				
				T4M	32,832	5	0	5	133	34,217	5	0	5	138	34,884	5	0	5	141				
				T4LG	29,861	4	0	4	121	31,120	4	0	4	126	31,727	5	0	4	128				
				TFTM	33,064	5	0	5	134	34,459	5	0	5	139	35,131	5	0	5	142				
				T5M	33,780	5	0	4	136	35,205	5	0	4	142	35,891	5	0	4	145				
				T5W	34,327	5	0	4	139	35,776	5	0	4	145	36,473	5	0	4	147				
				T5LG	33,878	5	0	3	137	35,307	5	0	3	143	35,995	5	0	3	145				
				BLC3	23,532	5	0	5	95	24,525	5	0	5	99	25,003	5	0	5	101				
				BLC4	24,303	5	0	5	98	25,328	5	0	5	102	25,822	5	0	5	104				
				RCCO	23,745	1	0	4	96	24,747	1	0	4	100	25,229	1	0	4	102				
				LCCO	23,745	1	0	4	96	24,747	1	0	4	100	25,229	1	0	4	102				
				AFR	34,526	5	0	5	139	35,983	5	0	5	145	36,684	5	0	5	148				

Performance Data

Lumen Output

Lumen values are from photometric tests performed in accordance with IESNA LM-79-08. Data is considered to be representative of configurations shown within the tolerances described within LM-79. Contact factory for performance data on any configurations not shown here.

Rotated Optics																			
Performance Package	System Watts	LED Count	Drive Current (mA)	Distribution Type	30K					40K					50K				
					(3000K, 70 CRI)					(4000K, 70 CRI)					(5000K, 70 CRI)				
					Lumens	B	U	G	LPW	Lumens	B	U	G	LPW	Lumens	B	U	G	LPW
P13	354W	90	1200	T1S	45,748	5	0	5	129	47,678	5	0	5	135	48,608	5	0	5	137
				T2M	42,380	5	0	5	120	44,168	5	0	5	125	45,029	5	0	5	127
				T3M	42,865	5	0	5	121	44,673	5	0	5	126	45,544	5	0	5	129
				T3LG	38,296	5	0	5	108	39,911	5	0	5	113	40,689	5	0	5	115
				T4M	43,503	5	0	5	123	45,339	5	0	5	128	46,222	5	0	5	131
				T4LG	39,566	5	0	5	112	41,235	5	0	5	117	42,039	5	0	5	119
				TFTM	43,811	5	0	5	124	45,659	5	0	5	129	46,549	5	0	5	132
				T5M	44,760	5	0	5	126	46,648	5	0	5	132	47,557	5	0	5	134
				T5W	45,485	5	0	5	129	47,404	5	0	5	134	48,328	5	0	5	137
				T5LG	44,889	5	0	3	127	46,783	5	0	3	132	47,695	5	0	3	135
				BLC3	31,181	5	0	5	88	32,496	5	0	5	92	33,130	5	0	5	94
				BLC4	32,202	5	0	5	91	33,561	5	0	5	95	34,215	5	0	5	97
				RCCO	31,463	2	0	5	89	32,790	2	0	5	93	33,429	2	0	5	94
				LCCO	31,463	2	0	5	89	32,790	2	0	5	93	33,429	2	0	5	94
				AFR	45,748	5	0	5	129	47,678	5	0	5	135	48,608	5	0	5	137
				P14	415W	90	1400	T1S	51,272	5	0	5	123	53,435	5	0	5	129	54,476
T2M	47,497	5	0					5	114	49,500	5	0	5	119	50,465	5	0	5	121
T3M	48,040	5	0					5	116	50,067	5	0	5	121	51,043	5	0	5	123
T3LG	42,919	5	0					5	103	44,730	5	0	5	108	45,602	5	0	5	110
T4M	48,756	5	0					5	117	50,813	5	0	5	122	51,803	5	0	5	125
T4LG	44,343	5	0					5	107	46,214	5	0	5	111	47,115	5	0	5	113
TFTM	49,101	5	0					5	118	51,172	5	0	5	123	52,169	5	0	5	126
T5M	50,164	5	0					5	121	52,280	5	0	5	126	53,299	5	0	5	128
T5W	50,977	5	0					5	123	53,127	5	0	5	128	54,163	5	0	5	130
T5LG	50,309	5	0					4	121	52,432	5	0	4	126	53,453	5	0	4	129
BLC3	34,945	5	0					5	84	36,420	5	0	5	88	37,130	5	0	5	89
BLC4	36,090	5	0					5	87	37,613	5	0	5	91	38,346	5	0	5	92
RCCO	35,261	2	0					5	85	36,749	2	0	5	88	37,465	2	0	5	90
LCCO	35,261	2	0					5	85	36,749	2	0	5	88	37,465	2	0	5	90
AFR	51,272	5	0					5	123	53,435	5	0	5	129	54,476	5	0	5	131

Dimensions

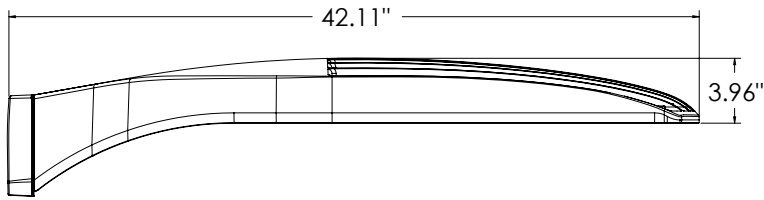

DSX2 with RPA, RPA5, SPA5, SPA8N mount
Weight: 48 lbs

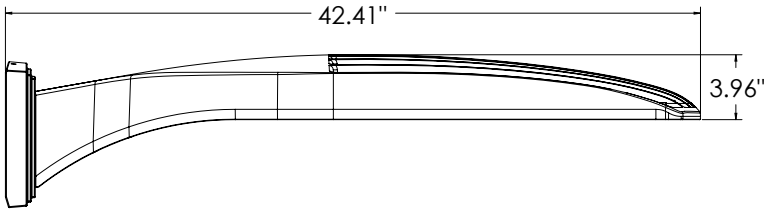
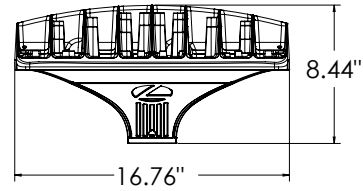

DSX2 with WBA mount
Weight: 50 lbs

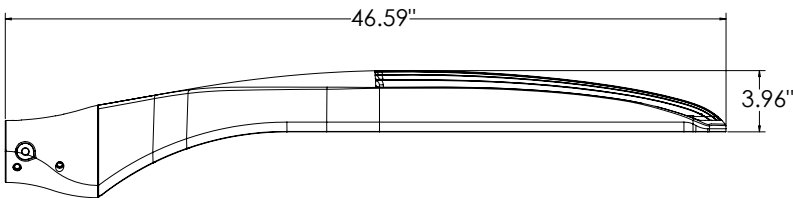
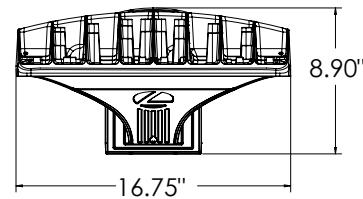

DSX2 with MA mount
Weight: 50 lbs

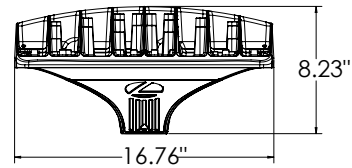

SPA (STANDARD ARM)

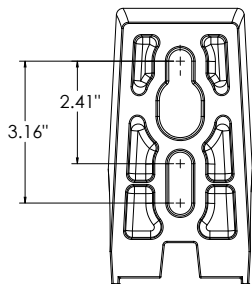

RPA

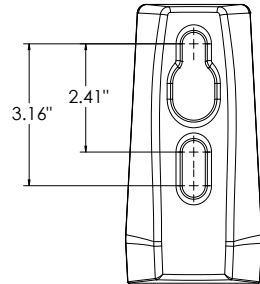

SPA5

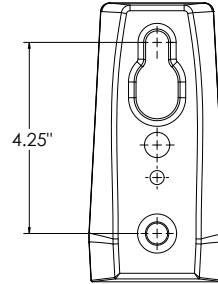

RPA5

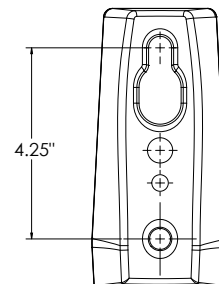

SPA8N

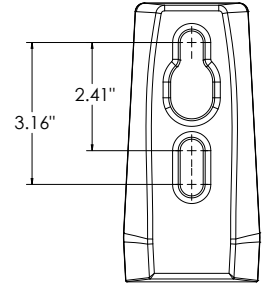

nLight Sensor Coverage Pattern

NLTAIR2 PIRHN

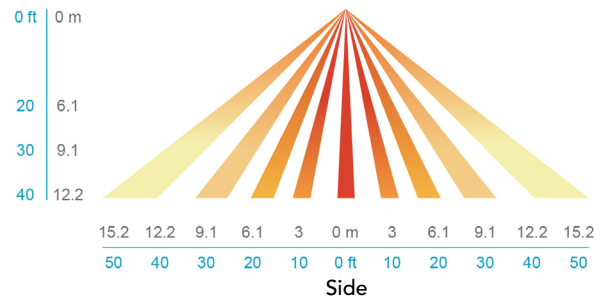
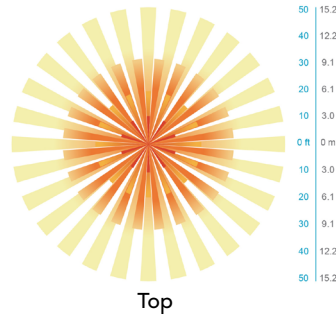
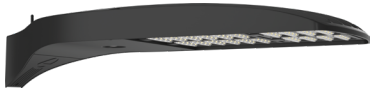

FEATURES & SPECIFICATIONS

INTENDED USE

The sleek design of the D-Series Area Size 2 reflects the embedded high performance LED technology. It is ideal for applications like car dealerships and large parking lots adjacent to malls, transit stations, grocery stores, home centers, and other big-box retailers.

CONSTRUCTION

Single-piece die-cast aluminum housing has integral heat sink fins to optimize thermal management through conductive and convective cooling. Modular design allows for ease of maintenance and future light engine upgrades. The LED drivers are mounted in direct contact with the casting to promote low operating temperature and long life. Housing driver compartment is completely sealed against moisture and environmental contaminants (IP66). Vibration rated per ANSI C136.31 for 1.5G. Low EPA (1.06 ft²) for optimized pole wind loading.

FINISH

Exterior parts are protected by a zinc-infused Super Durable TGIC thermoset powder coat finish that provides superior resistance to corrosion and weathering. A tightly controlled multi-stage process ensures a minimum 3 mils thickness for a finish that can withstand extreme climate changes without cracking or peeling. Available in both textured and non-textured finishes.

Coastal Construction (CCE)

Optional corrosion resistant construction is engineered with added corrosion protection in materials and/or pre-treatment of base material under super durable paint. Provides additional corrosion protection for applications near coastal areas. Finish is salt spray tested to over 5,000 hours per ASTM B117 with scribe rating of 10. Additional lead-times may apply.

OPTICS

Precision-molded proprietary silicone lenses are engineered for superior area lighting distribution, uniformity, and pole spacing. Light engines are available in 3000 K, 4000 K, or 5000 K (70 CRI) configurations. 80CRI configurations are also available. The D-Series Size 2 has zero uplight and qualifies as a Nighttime Friendly™ product, meaning it is consistent with the LEED® and Green Globes™ criteria for eliminating wasteful uplight.

ELECTRICAL

Light engine configurations consist of high-efficacy LEDs mounted to metal-core circuit boards to maximize heat dissipation and promote long life (up to L82/100,000 hrs at 25°C). Class 1 electronic drivers are designed to have a power factor >90%, THD <20%, and an expected life of 100,000 hours with <1% failure rate. Easily-serviceable 10kV surge protection device meets a minimum Category C Low operation (per ANSI/IEEE C62.41.2).

INSTALLATION

Integral mounting arm allows for fast mounting using Lithonia standard #8 drilling and accommodates pole drilling's from 2.41 to 3.12" on center. The standard "SPA" option for square poles and the "RPA" option for round poles use the #8 drilling. For #5 pole drillings, use SPA5 or RPA5. Additional mountings are available including a wall bracket (WBA) and mast arm (MA) option that allows luminaire attachment to a 2 3/8" horizontal mast arm.

STANDARD CONTROLS

The DSX2 LED area luminaire has a number of control options. DSX Size 2, comes standard with 0-10V dimming drivers. Dusk to dawn controls can be utilized via optional NEMA twist-lock photocell receptacles. Integrated motion sensor with on-board photocells feature field-adjustable programming and are suitable for mounting heights up to 40 feet. Control option BL features a bi-level device that allows a second control circuit to switch all light engines to either 30% or 50% light output.

nLIGHT AIR CONTROLS

The DSX2 LED area luminaire is also available with nLight® AIR for the ultimate in wireless control. This powerful controls platform provides out-of-the-box basic motion sensing and photocontrol functionality and is suitable for mounting heights up to 40 feet. Once commissioned using a smartphone and the easy-to-use CLAIRITY app, nLight AIR equipped luminaires can be grouped, resulting in motion sensor and photocell group response without the need for additional equipment. Scheduled dimming with motion sensor over-ride can be achieved when used with the nLight Eclipse. Additional information about nLight Air can be found [here](#).

LISTINGS

UL listed to meet U.S. and Canadian standards. UL Listed for wet locations. Light engines are IP66 rated; luminaire is IP66 rated. Rated for -40°C minimum ambient.

DesignLights Consortium® (DLC) Premium qualified product and DLC qualified product. Not all versions of this product may be DLC Premium qualified or DLC qualified. Please check the DLC Qualified Products List at www.designlights.org/QPL to confirm which versions are qualified.

International Dark-Sky Association (IDA) Fixture Seal of Approval (FSA) is available for all products on this page utilizing 3000K color temperature only.

WARRANTY

5-year limited warranty. This is the only warranty provided and no other statements in this specification sheet create any warranty of any kind. All other express and implied warranties are disclaimed. Complete warranty terms located at: www.acuitybrands.com/support/warranty/terms-and-conditions

Note: Actual performance may differ as a result of end-user environment and application. All values are design or typical values, measured under laboratory conditions at 25 °C. Specifications subject to change without notice.