

Type:
Job:

Fixture Options:

Ordered Separately from Fixture
See page 2

Approvals:

Fixture Catalog number:

Fixture and Finish

Mounting Options:

Ordered Separately from Fixture
See pages 3-4,

Date:
Page: 1 of 4

Specifications

Lamp Housing: Die-cast low copper aluminum, stainless steel fasteners and stainless steel set screw lock for aiming pivot.

Aiming: Aimable 358° vertically, horizontal aiming controlled by installation on mounting device.

Ravenna Yoke: Die-cast low copper aluminum, stainless steel fasteners and 1/2" NPSM brass nipple mount.

Lens: Tempered glass, 1/8" nominal thickness.

Gasketing: Silicone gaskets used throughout.

Transformer: Remote low voltage transformer required.

Wiring: 6' No. 18-2 12 volt cable with spade connectors for low voltage cable system connection.

Driver/Optical System: 3 LED emitters configured in a triangle array comprised together as a module. Each LED is encapsulated under a precision optical prism to produce a narrow flood pattern. The -40c driver is within the module and operates on 12V AC or DC current, 10 watt, 0.83 amp.

Finish: Each luminaire receives a fade and abrasion resistant, electrostatically applied, thermally cured, triglycidal isocyanurate (TGIC) polyester powdercoat finish. Standard colors include (BL) Black, (DB) Dark Bronze, Verde Green (GR).

Certification: UL Listed to U.S. and Canadian safety standards for wet locations.

ORDERING INFORMATION

Fixture	Finish
<input type="checkbox"/> KLVL171BL	Black
<input type="checkbox"/> KLVL171DB	Dark Bronze
<input type="checkbox"/> KLVL171GR	Verde Green

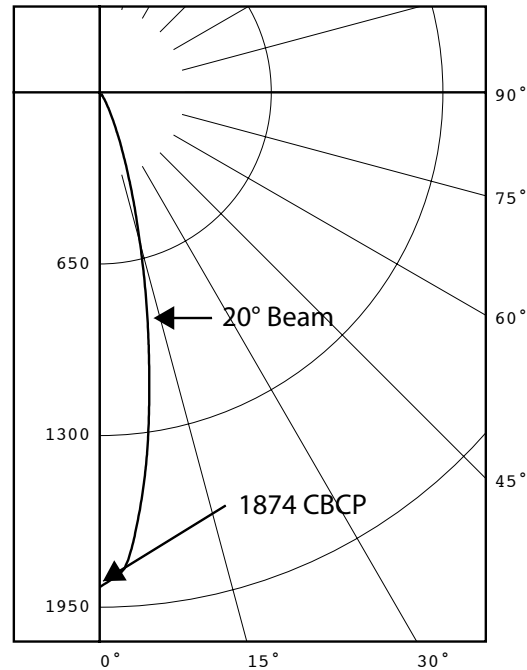

Catalog Number: KLVL171
 Report Number: k103894
 Voltage: 12 Watts: 10 Amps: 0.83
 Lumens: 394 CBCP: 1874 Beam: 20°
 CCT: 3000K Efficacy: 39.4 Lm/W

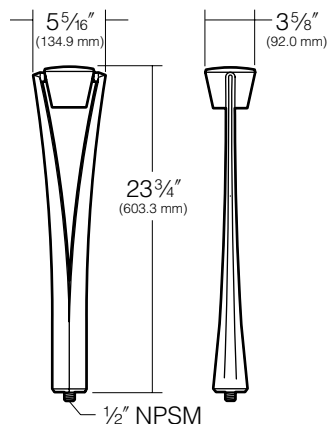

U.S. PATENT D407,842

KIM LIGHTING RESERVES THE RIGHT TO CHANGE SPECIFICATIONS WITHOUT NOTICE.

Type:



Job:

Page: 2 of 4



Fixture Options

Ordered Separately from Fixture

<p>Lens Accessories Cat. No. (See right) <input type="checkbox"/> No Option</p>	<p>HL - Hex Cell Louver: Constructed of hex cell aluminum louvers providing 45° cutoff, mounted in a circular frame, finished in baked high-heat flat black. Can be used in combination with colored lenses. Inserts behind lens.</p> <p>Cat. No. <input type="checkbox"/> HL Hex Cell Louver</p> 
	<p>PL - Prismatic Lens: Softens lamp distribution and flattens beam spread. Best with flood lamps. Replaces standard lens. Cannot be used in combination with HL louver.</p> <p>Cat. No. <input type="checkbox"/> PL Prismatic Lens</p> 
	<p>SL - Spread Lens: Creates an oval beam pattern, more narrow in one beam axis. Best with spot lamps. Replaces standard lens. Cannot be used in combination with HL louver.</p> <p>Cat. No. <input type="checkbox"/> SL Spread Lens</p> 
<p>Transformer Options</p>	<p>See "12-15 Volt Variable Transformers" on kimlighting.com - Product Specifications - Landscape 12 Volt-120Volt section.</p>

Type:

Job:



Mounting Options

Ordered Separately from Fixture

Landscape Light Post by Engineered Products Co.

Cat. No.

EP17

No Option

PVC fixture molded in black with 1/2" NPT mount is corrosion free and UV resistant. Replaces EMT, conduit connectors and weatherproof boxes. 100% shatter resistant against denting and cracking. Angled bottom to eliminate cable congestion.
 17 1/2" post length

CAUTION: The Ravenna Highlighter tray may be too heavy for the EP17. Any slight impact could damage the cap.

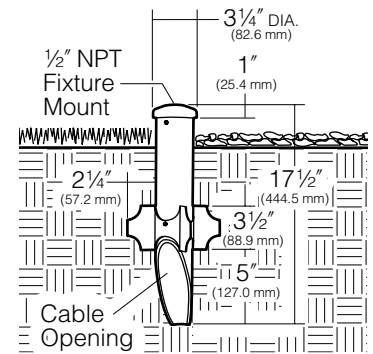

Low Voltage Spear Mount

Cat. No.

Finish

KLV400BL

Black

KLV400DB

Dark Bronze

KLV400GR

Verde Green

No Option

Die-cast low copper aluminum with 1/2" NPSM fixture mount. Stainless steel set screw locks fixture into mount. Cable slot allows easy fixture mounting before or after installation in ground. Super TGIC powder coat paint over clear anodizing and titanated zirconium conversion coating.

NOTE: The KLV400 must be installed in concrete.&

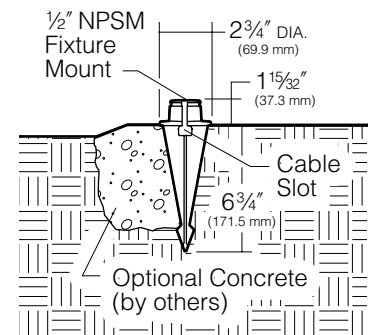

Architectural Junction Box

Cat. No.

Finish

JB1/BL

Black

JB1/DB

Dark Bronze

JB1/GR

Verde Green

No Option

Die-cast aluminum with 1/2" NPSM fixture mount. Internal set screw provided for locking position. Two 1/2" NPSM in bottom, 17 cu in. internal volume. Super TGIC powder coat paint over clear anodizing and titanated zirconium conversion coating.

Application Notes

- Elevates Accent Lights above ground cover to prevent foliage from blocking the light.
- Elevates Path Lights above ground cover to achieve a greater light throw.

CAUTION: Junction box must be installed high enough to avoid contact with soil or standing water.

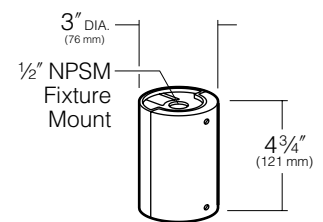

Type:

Job:

Page: 4 of 4



Mounting Options

Ordered Separately from Fixture

Brass In-grade Architectural Junction Box

Cat. No.

- JBR-2
- JBR-3
- JBR-21
- JBR-24
- No Option

Die-cast brass with 1/2" NPSM fixture mount and die-cast cover. Internal set screw provided for locking position. 18 cu in. internal volume.

- JBR-2** (2) 1/2" NPT in bottom
- JBR-3** (2) 3/4" NPT in bottom
- JBR-21** (2) 1/2" NPT in sides, (2) 1/2" NPT in bottom
- JBR-24** (4) 1/2" NPT in sides, (2) 1/2" NPT in bottom

All side taps provided with plugs.

25 Year Limited Warranty:

Solid brass junction boxes are warranted for 25 years, from date of sale, against manufacturing defects and failure due to corrosion.

Application Notes

- Creates a flush-mounted appearance.
- May be cast in concrete for increased stability.

CAUTION: Fixture stem and swivel must not contact soil or standing water. Provide drainage away from junction box.

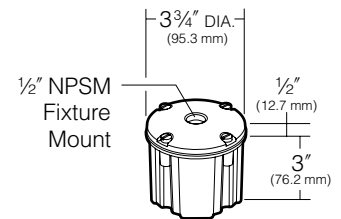

Composite In-Grade Architectural Junction Box

Cat. No.

- JBR-4
- JBR-5
- No Option

Composite box with 1/2" NPSM fixture mount and composite cover. 19 cu in. internal volume.

- JBR-4** (2) 3/4" NPT knockouts in bottom.
(4) 3/4" NPT knockouts on sides.
- JBR-5** Same as above but with brass cover.

CAUTION: Fixture stem and swivel must not contact soil or standing water. Provide drainage away from J-Box.

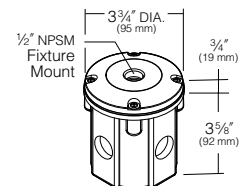

Stanchion Mount

Cat. No.

Finish

- SM18/BL Black
- SM18/DB Dark Bronze
- SM18/GR Verde Green
- No Option

3" O.D. by .188" wall cast aluminum with 1/2" NPSM fixture mount and hand hole with flush cover. Internal set screw fixture lock accessible through hand hole. Internal ground lug supplied with installed lead. Super TGIC powder coat paint over clear anodizing and titanated zirconium conversion coating.

