

Type: Job: Fixture Catalog number: <hr/> Fixture and Finish	Fixture Options: <hr/> Ordered Separately from Fixture See page 2 Mounting Options: <hr/> Ordered Separately from Fixture See pages 3-5	Approvals: Date: Page: 1 of 5
---	--	--

Specifications

Housing and Shield: Die-cast low copper aluminum.

Swivel: Die-cast aluminum with locking teeth and 1/2" solid brass NPT mount. Provides horizontal rotation independent of the threaded mount. Swivel locked by 1/4-20 stainless set screw. Clear anodized prior to powder coating for added corrosion resistance.

Lens: Convex clear tempered glass with silicone gasket.

Socket: Porcelain medium base.

Wiring: No. 18AWM rated 105°C.

Finish: Super TGIC thermoset polyester powder coat paint, 2.5 mil nominal thickness, applied over a titanated zirconium conversion coating; 2500 hour salt spray test endurance rating. Standard colors are Black (**BL**), Dark Bronze (**DB**), and Verde Green (**GR**).

Certification: UL Listed to U.S. and Canadian safety standards for wet locations.

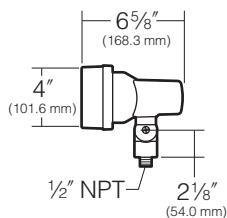

ORDERING INFORMATION

Fixture	Finish
<input type="checkbox"/> EL205BL	Black
<input type="checkbox"/> EL205DB	Dark Bronze
<input type="checkbox"/> EL205GR	Verde Green
Wattage / Lamp	
50W	
PAR20	
Halogen	
50W	
R20	
Incandescent	



KIM LIGHTING RESERVES THE RIGHT TO CHANGE SPECIFICATIONS WITHOUT NOTICE.

Type:

Job:

Page: 2 of 5



Fixture Options

Ordered Separately from Fixture

Type:

Job:

Page: 3 of 5



Mounting Options

Ordered Separately from Fixture

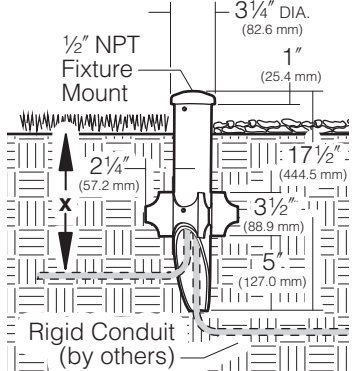
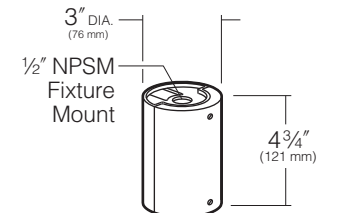
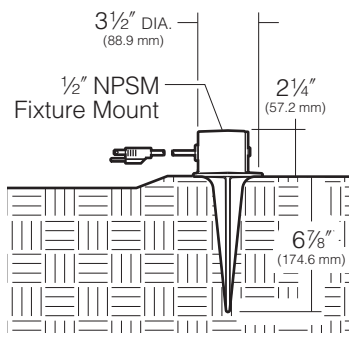
<p>Landscape Light Post by Engineered Products Co.</p> <p>Cat. No.</p> <p><input type="checkbox"/> EP17</p> <p><input type="checkbox"/> No Option</p>	<p>PVC fixture molded in black with 1/2" NPT mount is corrosion free and UV resistant. Replaces EMT, conduit connectors and weatherproof boxes. 100% shatter resistant against denting and cracking. Angled bottom to eliminate cable congestion.</p> <p>17 1/2" post length</p> <p>NOTE: EP17 should be used with a UL listed fixture and grounding means (i.e., third wire) suitable for use in wet locations.</p> <p>"x" = required depth of conduit per local codes.</p>	
<p>Architectural Junction Box</p> <p>Cat. No. Finish</p> <p><input type="checkbox"/> JB1/BL Black</p> <p><input type="checkbox"/> JB1/DB Dark Bronze</p> <p><input type="checkbox"/> JB1/GR Verde Green</p> <p><input type="checkbox"/> No Option</p>	<p>Die-cast aluminum with 1/2" NPSM fixture mount. Internal set screw provided for locking position. Two 1/2" NPSM in bottom, 17 cu in. internal volume. Super TGIC powder coat paint over clear anodizing and titanated zirconium conversion coating.</p> <p>NOTE: May also be used to hard mount low voltage fixtures.</p> <p>Application Notes</p> <ul style="list-style-type: none"> • Elevates Accent Lights above ground cover to prevent foliage from blocking the light. • Elevates Path Lights above ground cover to achieve a greater light throw. <p>CAUTION: Junction box must be installed high enough to avoid contact with soil or standing water.</p>	
<p>Portable Spear Mount</p> <p>Cat. No.</p> <p><input type="checkbox"/> J-25N</p> <p><input type="checkbox"/> No Option</p>	<p>Cast iron with 1/2" NPSM fixture mount. Hot dip galvanized finish. 5.5 cu in. splice compartment. (SJTW-A) 3 wire cord and plug.</p> <p>9' cord length</p>	

Type:

Job:

Page: 4 of 5



Mounting Options

Ordered Separately from Fixture

Brass In-grade Architectural Junction Box

Cat. No.

- JBR-2
 JBR-3
 JBR-21
 JBR-24
 No Option

Die-cast brass with 1/2" NPSM fixture mount and die-cast cover. Internal set screw provided for locking position. 18 cu in. internal volume.

JBR-2 (2) 1/2" NPT in bottom

JBR-3 (2) 3/4" NPT in bottom

JBR-21 (2) 1/2" NPT in sides, (2) 1/2" NPT in bottom

JBR-24 (4) 1/2" NPT in sides, (2) 1/2" NPT in bottom

All side taps provided with plugs.

NOTE: May also be used to hard mount low voltage fixtures.

25 Year Limited Warranty:

Solid brass junction boxes are warranted for 25 years, from date of sale, against manufacturing defects and failure due to corrosion.

Application Notes

- Creates a flush-mounted appearance.
- May be cast in concrete for increased stability.

CAUTION: Fixture stem and swivel must not contact soil or standing water. Provide drainage away from junction box.

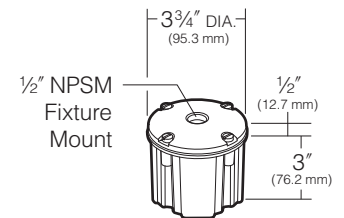

Brass In-grade Staked Junction Box

Cat. No.

- JBR30
 No Option

JBR30

BRASS IN-GRADE STAKED JUNCTION BOX

Die-cast brass with 1/2" NPSM fixture mount and die-cast cover. Internal set screw provided for locking position. 18 cu in. internal volume.

(2) 1/2" NPT in bottom with (2) 19" long brass stakes

NOTE: May also be used to hard mount low voltage fixtures.

Brass In-grade Staked Junction Box with Cord

Cat. No.

- JBR32
 No Option

JBR32

BRASS IN-GRADE STAKED JUNCTION BOX WITH CORD

Die-cast brass with 1/2" NPSM fixture mount and die-cast cover. Internal set screw provided for locking position. 18 cu in. internal volume. (SJTW-A) 3 wire cord and plug.

(2) 19" long brass stakes with 9' cord

25 Year Limited Warranty:

Solid brass junction boxes are warranted for 25 years, from date of sale, against manufacturing defects and failure due to corrosion.

Application Notes

- Creates a flush-mounted appearance.
- May be cast in concrete for increased stability.

CAUTION: Fixture stem and swivel must not contact soil or standing water. Provide drainage away from junction box.

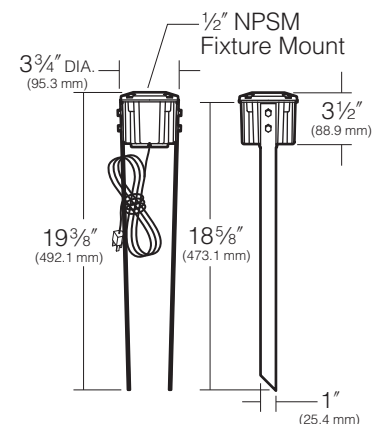

Type:

Job:

Page: 5 of 5



Mounting Options

Ordered Separately from Fixture

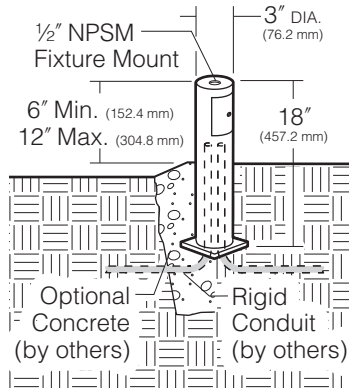
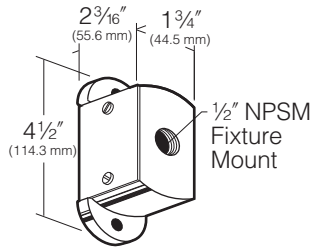
<p>Stanchion Mount</p> <p>Cat. No. Finish</p> <p><input type="checkbox"/> SM18/BL Black</p> <p><input type="checkbox"/> SM18/DB Dark Bronze</p> <p><input type="checkbox"/> SM18/GR Verde Green</p> <p><input type="checkbox"/> No Option</p>	<p>3" O.D. by .188" wall cast aluminum with 1/2" NPSM fixture mount and hand hole with flush cover. Internal set screw fixture lock accessible through hand hole. Internal ground lug supplied with installed lead. Super TGIC powder coat paint over clear anodizing and titanated zirconium conversion coating.</p> <p>NOTE: May also be used to hard mount low voltage fixtures.</p>	
<p>Surface Mount</p> <p>Cat. No. Finish</p> <p><input type="checkbox"/> J-27N/BL Black</p> <p><input type="checkbox"/> J-27N/DB Dark Bronze</p> <p><input type="checkbox"/> J-27N/GR Verde Green</p> <p><input type="checkbox"/> No Option</p>	<p>Cast aluminum with 1/2" NPSM fixture mount. Internal set screw provided for locking position. 5 cu in. internal volume. Super TGIC powder coat paint over clear anodizing and titanated zirconium conversion coating.</p> <p>NOTE: May also be used to hard mount low voltage fixtures.</p>	
<p>Architectural Wall Mount</p> <p>Cat. No. Finish</p> <p><input type="checkbox"/> JW/BL Black</p> <p><input type="checkbox"/> JW/DB Dark Bronze</p> <p><input type="checkbox"/> JW/GR Verde Green</p> <p><input type="checkbox"/> No Option</p>	<p>Die-cast aluminum with 1/2" NPSM fixture mount. Internal set screw provided for locking position. Canopy attaches to stainless steel wall plate for mounting to any standard electrical outlet box. Super TGIC powder coat paint over titanated zirconium conversion coating.</p> <p>NOTE: May also be used to hard mount low voltage fixtures.</p>	