

Features

- 6" Housing
- Ceramic bi-pin socket with aluminum heat shield
- Housing is vertically adjustable to accommodate up to a 2" ceiling thickness
- Steel housing is fully assembled for ease of installation
- 120V to 12V 75VA thermally protected magnetic transformer
- May be dimmed using dimmers specifically designed for magnetic transformers
- Real Nail® 3 bar hangers: telescoping system with pre-installed removable nail for easy repositioning of housing in joist construction • Integral T-bar mounting feature for secure installation in suspended ceilings • Pre-wired junction box with (5) 1/2" and (1) 3/4" knockouts with pryout slots, (4) non-metallic sheathed cable connectors, and ground wire
- UL Listed, C-UL/CSA certified for through-branch wiring, maximum (8) #12 AWG minimum 90° C branch circuit conductors (4 in, 4 out)
- Thermally protected against improper use of insulation
- MR16 lamp wattage ratings based on trim selection below



Description

Non-IC rated low voltage housing • Designed to be installed in non-insulated areas, or where insulation is spaced at least 3" from housing

Listings

UL Listed, C-UL/CSA certified for through-branch wiring and damp locations • Conforms with City of Chicago IP requirements





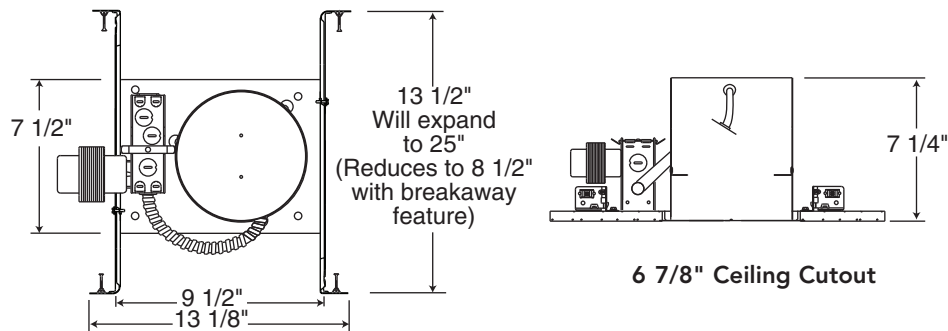

Ordering Information

Catalog Number: **TC45**

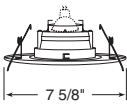
Dimensions

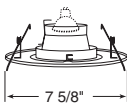

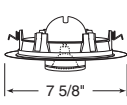
Adjustables

	Catalog # 454B-WH	Description Black Baffle, White Trim	Max. Lamp Rating 75W MR16 Aperture 3 1/2" Adjustment 35° vertical	 Baffle-Downlight/Adjustable
	Catalog # 457C-WH	Description Clear Alzak®, White Trim	Max. Lamp Rating 75W MR16 Aperture 3 1/2" Adjustment 35° vertical	 Cone-Downlight/Adjustable
	Catalog # 458W-WH	Description White Cylinder, White Baffle, White Trim	Max. Lamp Rating 50W MR16 Aperture 5 3/4" Adjustment 50° vertical	 Cylinder Spotlight in Baffle