



J6SLC RGBW

6" Smart Speaker LED Trim Kit

Project:
Fixture Type:
Location:
Contact/Phone:

J6SLC RGBW Series



Dimensions

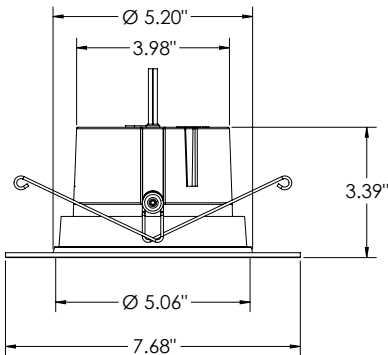

Specifications

Aperture: 5.06"
 Ceiling opening: 5.25"
 Overlap trim: 7.68"
 Height: 3.39"

Performance

Delivered Lumens	800L Nominal at 3000K
LED Color Temperature	Tunable White (2700K to 5000K) + RGB Colors
CRI	90+
Voltage	Dedicated 120 VAC
Dimming	Dimmable to 1% Not for use with Wall Dimmers

Product Features

The Smart Speaker Downlight provides smart home expansion with entertainment Bluetooth audio streaming, fully integrated smart lighting control with expanded RGBW lighting to set the perfect mood or theme for any occasion or activity. Once connected to the smart home platform via Bluetooth or Zigbee, the Smart Speaker LED trims can be controlled either via voice command, time schedules, or with the app. Commission through the SmartThings app or Alexa and Google voice assistant apps. Once installed, controlling the lighting from your mobile device is simple and easy to customize lighting from on/off, fine-tuning the color temperatures (2700K to 5000K) or RGB for full color spectrum options, dimming to set the mood, and grouping to control an entire lighting application at once.

The LED module maintains at least 70% light output for 50,000 hours.

- Direct set-up with or without a hub^{1,2}
- Pairs with smart devices to enable voice control
- Customize lighting to fine-tune the color temperatures (2700K to 5000K) or RGB for full color changing functionality
- Built-in Bluetooth speaker + Auto speaker grouping

Easy installation and serviceability

- See Quick Start Guide for Light Connectivity Options and Speaker Group Creation
- All-in-one design where electronics are integrated into trim replaces the existing lamp and trim
- Trim features quick connect plug for easy electrical connection in seconds
- Torsion springs are pre-installed and designed to fit into most 6" compatible recessed housings

Notes

- 1 For integration with Alexa: an Echo (4th Generation Smart Home Hub), Echo Plus, or Echo Show 10 is required. Integration with older Alexa devices will require an Amazon eero 6 Mesh Wifi system or a SmartThings hub.
- 2 For integration with Google speakers: a SmartThings hub is required when installing 6 or more light fixtures.

Applications

- Retrofit into existing 6" recessed housings or use with quick connect housings for new construction or remodel applications
- Wet rated and air-loc: perfect for showers, bathrooms, outdoor porches, decks, and eaves
- For use with housings installed in IC rated applications (direct contact with insulation)



J6SLC RGBW 6" Smart Speaker LED Trim Kit



ORDERING INFORMATION

6" Smart Speaker RGBW LED Trim Kit

Example: J6SLC RGBW MW M6

Series	Color Temperature	Finish	Options	Packaging
J6SLC 6" Smart Speaker LED RGBW Smooth Trim Kit	RGBW Tunable White (2700K to 5000K) + RGB Colors	MW Matte White	L/SKTWHIP¹ No E26 Adapter (CA only)	M6 Master Pack - Individually Packaged

Notes

1 L/SKTWHIP must be selected for product shipping to California.

Pairs perfectly with Juno housings for a complete downlight solution: Order housings as separate catalog number.

QC6 Series - New Construction Quick Connect LED Housing



QC6R Series - Remodel Quick Connect LED Housing



Bluetooth App



Master Speaker



Max. Range
60' (18m)

Satellite Speakers - from 1 to 12

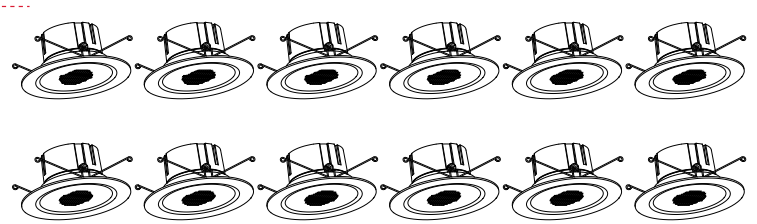



J6SLC RGBW

6" Smart Speaker LED Trim Kit



Specifications/Electrical Data

LED Downlight Retrofit Trim

Aluminum die cast trim with polycarbonate housing in matte white finish

- Pressed-in diffusing lens optimized for concealing the LEDs from direct view in the on and off state
- All-in-one design where LED light engine mounts directly to the trim for ease of installation into existing 6" recessed housings with medium base sockets or quick connect LED housings
- Provided with torsion springs

LED LIGHT ENGINE

LEDs are integrated to one piece high purity aluminum, thermally conductive housing to provide uninterrupted heat transfer to ensure long life of the LED.

- Tunable white color temperatures (2700K to 5000K) or RGB for full color changing functionality
- 90 CRI minimum
- Accommodates 120 volts AC at 60Hz

Optical System

Diffused lens surrounding speaker provides even light distribution for general illumination

- Optimized for wide fixture spacings
- Up to 800 nominal lumens is equivalent to 75W BR30 lamp.

Electrical Connections

High-efficiency driver mounted on the module. 1 x 1 4Ω, 5W loudspeaker

- Trim features quick connect plug installed as standard for installation into Juno quick connect housings with mating connector
- Trim ships with a medium base socket adapter whip for installation into 6" incandescent housings with medium base sockets.

Life

Rated for 50,000 hours at 70% lumen maintenance.

Labels

CSA certified to US and Canadian safety standards

- Suitable for wet location, covered ceiling
- Air-Loc certified in accordance with ASTM E283-2004
- NOM Certified

Testing: All reports are based on published industry procedures; field performance may differ from laboratory performance.

Warranty

3-year limited warranty. This is the only warranty provided and no other statements in this specification sheet create any warranty of any kind. All other express and implied warranties are disclaimed. Complete warranty terms located at: www.acuitybrands.com/support/warranty/terms-and-conditions

Note: Actual performance may differ as a result of end-user environment and application.

All values are design or typical values, measured under laboratory conditions at 25 °C.

Specifications subject to change without notice.

PERFORMANCE DATA

J6SLC	
Input Voltage	120V
Input Power Typical	12.8W (+/-5%)
Power Factor	.9
Frequency	60 Hz
EMI/RFI	FCC Title 47, Part 15 Class B (consumer)
Minimum Starting Temp	-20°C (-4°F) minimum

Note: Actual performance may differ as a result of end-user environment and application. All values are design or typical values, measured under laboratory conditions at 25° C

LIGHTING PERFORMANCE DATA DONNÉES SUR LE RENDEMENT DE L'ÉCLAIRAGE	
Light Appearance (CCT) Aspect de la lumière (CCT)	
2700K soft white blanc doux	
782 lumens 61 lumens per watt	
3000K warm white blanc chaud	
798 lumens 62 lumens per watt	
3500K neutral white blanc neutre	
829 lumens 65 lumens per watt	
4000K cool white blanc froid	
837 lumens 65 lumens per watt	
5000K daylight blanc neutre	
837 lumens 65 lumens per watt	
Watts	12.8
Color Accuracy (CRI) Précision des couleurs (CRI)	90



J6SLC RGBW

6" Smart Speaker LED Trim Kit



PHOTOMETRICS

J6SLC RGBW MW M6 - 2700K Input Watts: 12.8, Delivered Lumens: 782, LPW: 61.1, S/MH: 1.23, Test No: ISF 231045P1

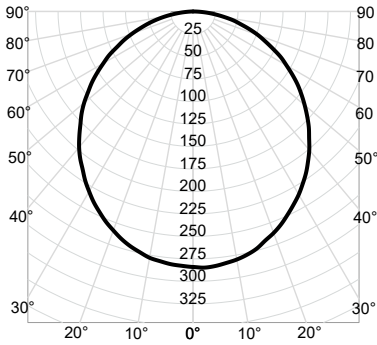

CP Summary	Zonal Lumen Summary				Coefficients of Utilization										Cone of Light			Luminance (cd/sq.m)	
	0°	Zone	Lumens	% Fixture	pw	80%		70%		50%		Mounting Height	Initial FC Center Beam	Beam Diameter	Average Luminance				
						50%	30%	10%	50%	30%	10%					50%	30%	10%	
0°	284	0° - 30°	218	28%	0	119	119	119	116	116	116	111	111	111	6.0	7.9	16.7	0°	21,050
5°	284	0° - 40°	353	45%	1	104	99	96	102	98	94	97	94	91	8.0	4.4	22.2	45°	19,078
15°	273	0° - 60°	615	79%	2	90	84	78	89	82	77	85	80	75	10.0	2.8	27.8	55°	18,350
25°	249	0° - 90°	782	100%	3	79	71	65	78	70	64	75	68	63	12.0	2.0	33.3	65°	17,188
35°	219	90° - 180°	0	0%	4	70	62	55	69	61	54	67	59	54	14.0	1.4	38.9	75°	15,751
45°	182	0° - 180°	782	100%	5	63	54	47	62	53	47	60	52	46				85°	13,607
55°	142				6	57	48	41	56	47	41	54	46	41					
65°	98				7	51	43	36	51	42	36	49	42	36					
75°	55				8	47	38	33	46	38	32	45	38	32					
85°	16				9	43	35	29	43	35	29	41	34	29					
90°	0				10	40	32	27	39	32	27	38	31	26					

Beam Angle: 108.5°
Field Angle: 163.3°

J6SLC RGBW MW M6 - 3000K Input Watts: 12.8, Delivered Lumens: 798, LPW: 62.3, S/MH: 1.23, Test No: ISF 231045P2

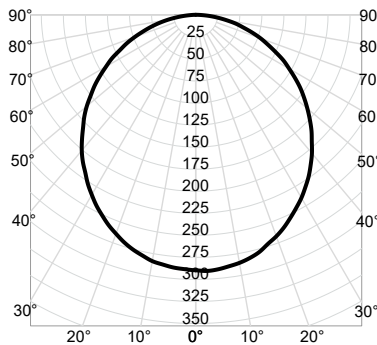

CP Summary	Zonal Lumen Summary				Coefficients of Utilization										Cone of Light			Luminance (cd/sq.m)	
	0°	Zone	Lumens	% Fixture	pw	80%		70%		50%		Mounting Height	Initial FC Center Beam	Beam Diameter	Average Luminance				
						50%	30%	10%	50%	30%	10%					50%	30%	10%	
0°	290	0° - 30°	222	28%	0	119	119	119	116	116	116	111	111	111	6.0	8.0	16.7	0°	21,471
5°	290	0° - 40°	360	45%	1	104	99	96	102	98	94	97	94	91	8.0	4.5	22.2	45°	19,459
15°	278	0° - 60°	628	79%	2	90	84	78	89	82	77	85	80	75	10.0	2.9	27.8	55°	18,717
25°	254	0° - 90°	798	100%	3	79	71	65	78	70	64	75	68	63	12.0	2.0	33.3	65°	17,532
35°	223	90° - 180°	0	0%	4	70	62	55	69	61	54	67	59	54	14.0	1.5	38.9	75°	16,066
45°	186	0° - 180°	798	100%	5	63	54	47	62	53	47	60	52	46				85°	13,879
55°	145				6	57	48	41	56	47	41	54	46	41					
65°	100				7	51	43	36	51	42	36	49	42	36					
75°	56				8	47	38	33	46	38	32	45	38	32					
85°	16				9	43	35	29	43	35	29	41	34	29					
90°	0				10	40	32	27	39	32	27	38	31	26					

Beam Angle: 108.5°
Field Angle: 163.3°

J6SLC RGBW MW M6 - 3500K Input Watts: 12.8, Delivered Lumens: 829, LPW: 64.8, S/MH: 1.23, Test No: ISF 231045P3

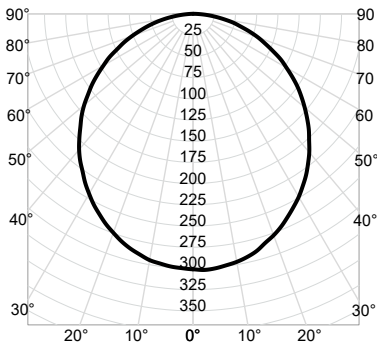

CP Summary	Zonal Lumen Summary				Coefficients of Utilization										Cone of Light			Luminance (cd/sq.m)	
	0°	Zone	Lumens	% Fixture	pw	80%		70%		50%		Mounting Height	Initial FC Center Beam	Beam Diameter	Average Luminance				
						50%	30%	10%	50%	30%	10%					50%	30%	10%	
0°	301	0° - 30°	231	28%	0	119	119	119	116	116	116	111	111	111	6.0	8.4	16.7	0°	22,313
5°	301	0° - 40°	374	45%	1	104	99	96	102	98	94	97	94	91	8.0	4.7	22.2	45°	20,223
15°	289	0° - 60°	652	79%	2	90	84	78	89	82	77	85	80	75	10.0	3.0	27.8	55°	19,451
25°	264	0° - 90°	829	100%	3	79	71	65	78	70	64	75	68	63	12.0	2.1	33.3	65°	18,219
35°	232	90° - 180°	0	0%	4	70	62	55	69	61	54	67	59	54	14.0	1.5	38.9	75°	16,696
45°	193	0° - 180°	829	100%	5	63	54	47	62	53	47	60	52	46				85°	14,424
55°	151				6	57	48	41	56	47	41	54	46	41					
65°	104				7	51	43	36	51	42	36	49	42	36					
75°	58				8	47	38	33	46	38	32	45	38	32					
85°	17				9	43	35	29	43	35	29	41	34	29					
90°	0				10	40	32	27	39	32	27	38	31	26					

Beam Angle: 108.5°
Field Angle: 163.3°



J6SLC RGBW

6" Smart Speaker LED Trim Kit



PHOTOMETRICS

J6SLC RGBW MW M6 - 4000K Input Watts: 12.8, Delivered Lumens: 837, LPW: 65.4, S/MH: 1.23, Test No: ISF 231045P4

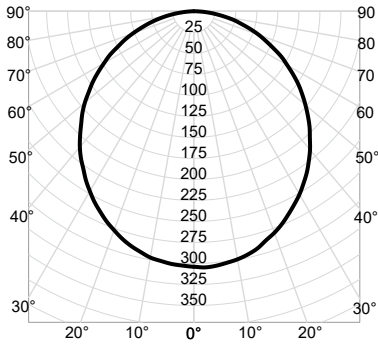

CP Summary		Zonal Lumen Summary				Coefficients of Utilization										Cone of Light			Luminance (cd/sq.m)	
0°	Zone	Lumens	% Fixture	pw	50%	30%	10%	50%	30%	10%	50%	30%	10%	Mounting Height	Initial FC Center Beam	Beam Diameter	Average Luminance			
0°	0° - 30°	233	28%	0	119	119	119	116	116	116	111	111	111	6.0	8.4	16.7	0°	22,524		
5°	0° - 40°	378	45%	1	104	99	96	102	98	94	97	94	91	8.0	4.7	22.2	45°	20,413		
15°	0° - 60°	658	79%	2	90	84	78	89	82	77	85	80	75	10.0	3.0	27.8	55°	19,635		
25°	0° - 90°	837	100%	3	79	71	65	78	70	64	75	68	63	12.0	2.1	33.3	65°	18,391		
35°	90° - 180°	0	0%	4	70	62	55	69	61	54	67	59	54	14.0	1.6	38.9	75°	16,854		
45°	0° - 180°	837	100%	5	63	54	47	62	53	47	60	52	46	Beam Angle: 108.5°			85°	14,560		
55°	152	Field Angle: 163.3°																		
65°	105																			
75°	59																			
85°	17																			
90°	0																			

J6SLC RGBW MW M6 - 5000K Input Watts: 12.8, Delivered Lumens: 837, LPW: 65.4, S/MH: 1.23, Test No: ISF 231045P5

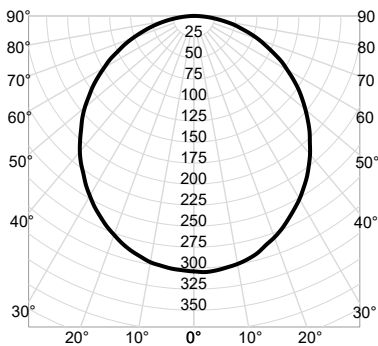

CP Summary		Zonal Lumen Summary				Coefficients of Utilization										Cone of Light			Luminance (cd/sq.m)	
0°	Zone	Lumens	% Fixture	pw	50%	30%	10%	50%	30%	10%	50%	30%	10%	Mounting Height	Initial FC Center Beam	Beam Diameter	Average Luminance			
0°	0° - 30°	233	28%	0	119	119	119	116	116	116	111	111	111	6.0	8.4	16.7	0°	22,524		
5°	0° - 40°	378	45%	1	104	99	96	102	98	94	97	94	91	8.0	4.7	22.2	45°	20,413		
15°	0° - 60°	658	79%	2	90	84	78	89	82	77	85	80	75	10.0	3.0	27.8	55°	19,635		
25°	0° - 90°	837	100%	3	79	71	65	78	70	64	75	68	63	12.0	2.1	33.3	65°	18,391		
35°	90° - 180°	0	0%	4	70	62	55	69	61	54	67	59	54	14.0	1.6	38.9	75°	16,854		
45°	0° - 180°	837	100%	5	63	54	47	62	53	47	60	52	46	Beam Angle: 108.5°			85°	14,560		
55°	152	Field Angle: 163.3°																		
65°	105																			
75°	59																			
85°	17																			
90°	0																			