

# JUNO®

Project: \_\_\_\_\_

Fixture Type: \_\_\_\_\_

Location: \_\_\_\_\_

Contact/Phone: \_\_\_\_\_

## 5" TC 900 LUMEN LED DOWNLIGHT NEW CONSTRUCTION

### TC920LEDG4 RECESSED HOUSING OPEN TRIMS



#### PRODUCT DESCRIPTION

Dedicated LED new construction housing with integral light engine • Shallow housing allows for fit in 2 x 6 construction • TC housing design for use in non-insulated areas • If installed where insulation is present, the insulation must be pulled back 3" from all sides of the TC housing • LED housing is designed to provide 50,000 hours of life and is compatible with many standard Juno trims • 5 year limited warranty on LED components.

#### ENVIRONMENTALLY FRIENDLY, ENERGY EFFICIENT

- No harmful ultraviolet or infrared wavelengths
- No lead or mercury
- Comparable light output to 26W compact fluorescent while consuming only 18W\*

#### PRODUCT SPECIFICATIONS

**LED Light Engine** LED array integrated to one piece high purity aluminum, thermally conductive housing provides uninterrupted heat transfer to ensure long life of the LED • Replaceable light engine mounts directly to housing and incorporates the latest generation, high lumen output LED array • LEDs are binned within a 3-Step MacAdam Ellipse exceeding ENERGY STAR® requirements yielding superior fixture to fixture color uniformity • 2700K, 3000K, 3500K or 4100K color temperatures available • 90 CRI minimum.

**Optical System** Computer-optimized reflector design with high reflectance white finish coupled with a high transmission diffusing lens conceals the LEDs and produces uniform aperture luminance • Deep regression of lens produces a low glare, efficient system that can produce over 900 lumens with select trims (see page 2 for details) using 18W\* • Wide flood distribution shipped as standard with optional optic accessories available and sold separately.

**Aesthetic Trim Selections** Compatible with wide selection of existing Juno trims • Shadow free, knife edge design blends seamlessly into ceiling.

**LED Driver** Universal voltage driver that accommodates input voltage from 120-277 volts AC at 50/60Hz is standard and is dimmable with the use of most 0-10V dimmers • Power factor > 0.9 at 120V input • Optional Lutron Hi-Lume® A-Series driver accommodates 120-277 volts AC at 50/60Hz • Mounted between the j-box and housing for easy access and cool operation • For a list of compatible dimmers, see [JUNOTCLED-DIM](#).

**Emergency Battery Option** Battery factory assembled to housing with remote mounted test switch included • Drives LED array for 90 minutes to meet Life Safety Code (NFPA-LSC), National Electrical Code (NEC) and UL requirements • Provides 50% light output in emergency mode.

**Life** Rated for 50,000 hours at 70% lumen maintenance.

**Labels** ENERGY STAR® Qualified when used with select baffle and cone trims • UL listed for U.S. and Canada through-branch wiring, damp locations • Union made • UL and cUL listed.

**Testing** All reports are based on published industry procedures; field performance may differ from laboratory performance.

Product specifications subject to change without notice.

#### HOUSING FEATURES

**Housing** Designed for use in TC applications (non-insulated) • Aluminum housing • Housing is vertically adjustable to accommodate up to a 2" ceiling thickness.

**Junction Box** Pre-wired junction box provided with (5) 1/2" and (1) 3/4" knockouts and ground wire, UL listed and cUL listed for through-branch wiring, maximum 8 No. 12 AWG 90° C branch circuit conductors (4 in, 4 out) • Junction box provided with removable access plates • Knockouts equipped with pryout slots.

**Mounting Frame** 16-gauge galvanized steel mounting ring equipped with vertically adjustable mounting brackets that accept 1/2" conduit or "C" channels (HB-26 or HB-50), linear flat bars (LB-27) or Real Nail® 3 bar hangers (HB-1).

\*Nominal input wattage @ 120V with standard universal voltage driver under stable operating conditions

#### DIMENSIONS

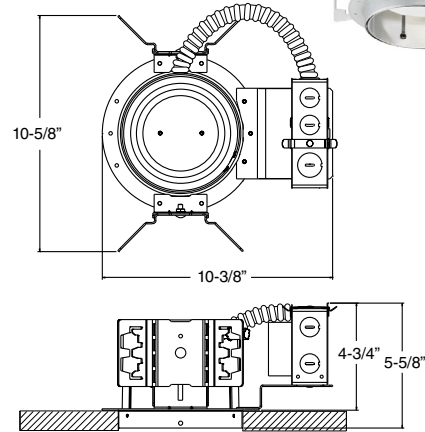

5 5/8" CEILING CUTOUT

#### ELECTRICAL DATA

##### STANDARD UNIVERSAL VOLTAGE DRIVER (-U)

	120V	277V
Input Power	18W (+/-5%)	18W (+/-5%)
Input Current - Max	0.15A	0.07A
Frequency	50/60Hz	50/60Hz
EMI/RFI	FCC Title 47 CFR, Part 15, Class A (Commercial)	FCC Title 47 CFR, Part 15, Class A (Commercial)
Minimum starting temp	-40°C (-40°F)	-40°C (-40°F)

##### UNIVERSAL VOLTAGE DRIVER WITH EMERGENCY OPTION (-UBR)

	120V	277V
Input Power	21.3W (+/-5%)	21.3W (+/-5%)
Input Current - Max	0.33A	0.30A
Frequency	50/60Hz	50/60Hz
EMI/RFI	FCC Title 47 CFR, Part 15, Class A (Commercial)	FCC Title 47 CFR, Part 15, Class A (Commercial)
Minimum starting temp	0°C (32°F)	0°C (32°F)

##### LUTRON HI-LUME® LED DRIVER (-L)

	120V	277V
Input Power	17.8W (+/-5%)	17.8W (+/-5%)
Input Current - Max	0.15A	0.06A
Frequency	50/60Hz	50/60Hz
EMI/RFI	FCC Title 47 CFR, Part 15, Class A (Commercial)	FCC Title 47 CFR, Part 15, Class A (Commercial)
Minimum starting temp	0°C (32°F)	0°C (32°F)

##### LUTRON HI-LUME® LED DRIVER WITH EMERGENCY OPTION (-LBR)

	120V	277V
Input Power	21W (+/-5%)	21W (+/-5%)
Input Current - Max	0.33A	0.29A
Frequency	50/60Hz	50/60Hz
EMI/RFI	FCC Title 47 CFR, Part 15, Class A (Commercial)	FCC Title 47 CFR, Part 15, Class A (Commercial)
Minimum starting temp	0°C (32°F)	0°C (32°F)

# 5" TC 900 LUMEN LED DOWNLIGHT NEW CONSTRUCTION

## TC920LEDG4 RECESSED HOUSING OPEN TRIMS

**ORDERING INFORMATION:** Housing, trim and accessories each ordered separately.

Example: **TC920LEDG4-27K-UBR**













Catalog No.	Color Temp.	Voltage	Options
TC920LEDG4	27K 2700K 3K 3000K 35K 3500K 41K 4100K	U Universal Voltage 120-277V (0-10V dimming) L Lutron Hi-Lume 3-wire Dimming Ecosystem® Compatible	BR Emergency Battery Back-up w/ Remote Switch CP Chicago Plenum Chicago Plenum is not available with emergency option

Example: **HB-26**

**Accessories**

Cat. #	Description	Cat. #	Description
HB-1	Two 13 1/2" - 25" Real Nail® 3 bar hangers	LEDOPTICG3-M	Medium Flood Optic (50°)
HB-26	Two 26" C-channel bar hangers	LEDOPTICG3-N	Narrow Flood Optic (37°)
HB-50	Two 50" C-channel bar hangers	LEDOPTICG3-S	Spot Optic (10°)
LB-27	Two 27" linear bar hangers	TR5-ABZ	Trim Ring - Classic Age Bronze
		TR5-BL	Trim Ring - Black
		TR5-SC	Trim Ring - Satin Chrome
		TR5-WH	Trim Ring - White

Example: **205W-WH**

Trim/Description	
	<b>205W-W</b> White Baffle
	<b>205B-WH1</b> Black Baffle
	<b>205B-SC1</b> Black Baffle
	<b>205B-ABZ1</b> Black Baffle
	<b>204C-WH</b> Cone in Clear Alzak®
	<b>204G-WH</b> Cone in Gold Alzak®
	<b>204B-WH1</b> Cone in Black Alzak®
	<b>204PT-SC</b> Cone in Pewter Alzak®
	<b>204W-WH</b> Cone in Gloss White
	<b>204HZ-WH</b> Cone in Haze
	<b>204WHZ-WH</b> Cone in Wheat Haze
	<b>204WHZ-ABZ</b> Cone in Wheat Haze

<sup>1</sup>Not ENERGY STAR® Qualified.

Trim Size: 6 1/4" O.D.

Trim Finish: ABZ - Classic Aged Bronze, SC - Satin Chrome, WH - White. Alzak is a registered trademark of Alcoa Corp.

Note: In Canada when insulation is present, Type IC fixtures must be used.

**PHOTOMETRIC REPORT**

Test Report #: PT02141404R  
Catalog No: TC920LEDG4-35K-U  
with 205W-WH White Baffle Trim and Standard Wide Flood Optic

Luminaire Spacing Criterion: 1.10  
Luminaire LPW: 58

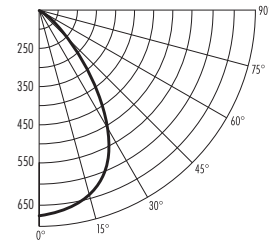

**CANDLEPOWER DISTRIBUTION (Candelas)**

Degrees Vertical	0°
0	685
5	681
15	648
25	556
35	371
45	161
55	90
65	52
75	31
85	6
90	0

Multiplier: 27K - 0.93  
3K - 0.99  
41K - 1.01

**AVERAGE INITIAL FOOTCANDLES**

Multiple Units (Square Array, 60"x60' room)  
Ceiling 80% Wall 50% Floor 20%

Spacing	RCR1	RCR3	RCR5
4.0'	70	57	48
5.0'	44	36	30
6.0'	31	25	21
7.0'	25	20	17
8.0'	20	16	14
9.0'	15	12	10
10.0'	11	9	8

**ZONAL LUMEN SUMMARY**

Zone	Lumens	%Lamp	%Fixture
0-30°	501	N/A	48.6
0-40°	729	N/A	70.7
0-60°	939	N/A	91.1
0-90°	1031	N/A	100.0

**INITIAL FOOTCANDLES (One Unit, 17.8W, 72° Beam)**

Distance to Illuminated Plane (Feet)	Footcandles Beam Center	Beam Diameter
4	42.8	5.8'
6	19.0	8.7'
8	10.7	11.6'
10	6.9	17.4'

**LUMINANCE (Average cd/m²)**

Degrees	Average 0° Luminance
45	21580
55	14842
65	11575
75	11228
85	7037

**PHOTOMETRIC REPORT**

Test Report #: LTL25981R  
Catalog No: TC920LEDG4-35K-U  
with 204C-WH Clear Alzak® Trim and Standard Wide Flood Optic

Luminaire Spacing Criterion: 1.26  
Luminaire LPW: 65

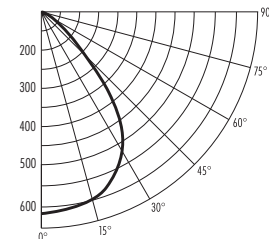

**CANDLEPOWER DISTRIBUTION (Candelas)**

Degrees Vertical	0°
0	628
5	624
15	602
25	567
35	465
45	252
55	130
65	62
75	11
85	0
90	0

Multiplier: 27K - 0.93  
3K - 0.99  
41K - 1.01

**AVERAGE INITIAL FOOTCANDLES**

Multiple Units (Square Array, 60"x60' room)  
Ceiling 80% Wall 50% Floor 20%

Spacing	RCR1	RCR3	RCR5
4.0'	79	64	53
5.0'	50	41	34
6.0'	35	29	24
7.0'	28	23	19
8.0'	22	18	15
9.0'	17	14	12
10.0'	13	10	9

**ZONAL LUMEN SUMMARY**

Zone	Lumens	%Lamp	%Fixture
0-30°	490	N/A	42.0
0-40°	775	N/A	66.4
0-60°	1090	N/A	93.3
0-90°	1168	N/A	100.0

**INITIAL FOOTCANDLES (One Unit, 17.8W, 83.8° Beam)**

Distance to Illuminated Plane (Feet)	Footcandles Beam Center	Beam Diameter
4	39.2	7.2'
6	17.4	10.8'
8	9.8	14.4'
10	6.3	17.9'

**LUMINANCE (Average cd/m²)**

Degrees	Average 0° Luminance
45	34695
55	22020
65	14303
75	4119
85	0

Fixtures tested to IES recommended standard for solid state lighting per LM-79-08. Photometric performance on a single unit represents a baseline of performance for the fixture. Results may vary in the field.

