



5" SHALLOW UNIVERSAL IC HOUSING

INCANDESCENT LAMPS

IC25W

Project: _____

Fixture Type: _____

Location: _____

Contact/Phone: _____

PRODUCT DESCRIPTION

IC Air-Loc® Housing • Energy efficient, sealed housing • Can be completely covered with insulation • When used with Air-Loc Gasket (see accessories), stops infiltration and exfiltration of air, reducing heating and cooling costs • Trims shown with Air-Loc symbol **Air-Loc** do not require a gasket.

PRODUCT SPECIFICATIONS

Lamp Lamp ratings based on trim selected—see reverse.

Socket Medium base porcelain with nickel-plated copper screw shell • Floating socket with spring attaches to trim for installation.

Trims Trim selection shown on reverse.

Labels UL/cUL listed for through-branch wiring, damp locations and IP • Product thermally protected against improper use of lamps • Union made AFL-CIO • UL and cUL Listed • Trim No. 212 is wet location approved for covered ceiling applications • Trims 275 and 276 are wet location approved for covered ceiling applications, **when used with outdoor rated PAR lamps.**

Testing All reports are based on published industry procedures; field performance may differ from laboratory performance.

Product specifications subject to change without notice.

INSTALLATION

Real Nail® 3 Bar Hangers Telescoping, patented Real Nail® 3 system permits quick placement of housing anywhere within 24" O.C. joists or suspended ceilings • Integral T-bar mounting feature secures housing in suspended ceiling grid – no accessory clips required • 24" expansion stop allows quick placement of fixture in standard grid spacing • Bars scored in two locations for fast, clean breaking, allowing housing installation in tight applications • Bars captive to mounting frame • Edge-mounted for extra strength • Captive bugle-headed ring shank nail for quick one-step installation and easy removal with claw hammer for fixture relocation • May be installed either perpendicular or parallel to junction box • Quick-Loc slot (location identified on the mounting frame) and oversized locking set screw lock fixture in position • Bar hanger foot contoured to align to bottom of construction joist • Alternate mounting holes included.

Junction Box Pre-wired junction box provided with (5) ½" and (1) ¾" knockouts, (4) Non-metallic sheathed cable connectors and ground wire, UL/cUL Listed for through branch wiring, maximum 8 No. 12 AWG 90° C branch circuit conductors (4 in, 4 out) • Junction box provided with removable access plates • Knockouts equipped with pryout slots • Supplied with **push-in electrical connectors** for fast installation.

Mounting Frame 22-gauge die-formed galvanized steel mounting frame • Rough-in section (junction box, mounting frame, housing and bar hangers) fully assembled for ease of installation • Sight lines embossed on mounting frame to allow for easy viewing when aligning fixtures.

Housing IC housing, .032" aluminum sealed for Air-Loc Compliance • Housing is vertically adjustable to accommodate up to a 1" ceiling thickness.

PRODUCT CODES

Catalog Number	Input Voltage	Lamp Rating (max.)
IC25W	120V	R20/PAR20/BR30/PAR30/PAR30L (See reverse for max. trim rating)

REV-11/09

DIMENSIONS

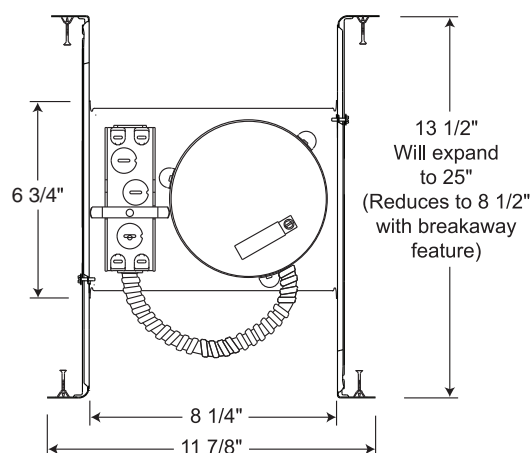
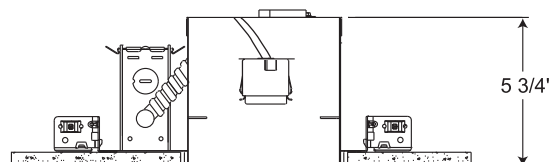

5 5/8" CEILING CUTOUT

ACCESSORIES

Catalog No.	Description
ALG5	Air-Loc Gasket











To order, specify catalog number.

5" SHALLOW UNIVERSAL IC HOUSING

INCANDESCENT LAMPS

IC25W

TRIMS/LAMPS

	Cat. No.	Description	Max. Lamp Rating
	 275B-WH ◆◆ 275W-WH ◆◆	Shallow Baffle - Black Shallow Baffle - White	50W BR30, 50W PAR30, 50W PAR30L
	 276B-WH ◆◆ 276C-WH ◆◆ 276HZ-WH ◆◆ 276WHZ-WH ◆◆ 276W-WH ◆◆	Shallow Cone - Black Alzak® Shallow Cone - Clear Alzak® Shallow Cone - Haze Shallow Cone - Wheat Haze Shallow Cone - White	50W BR30, 50W PAR30, 50W PAR30L
	 208B-WH 208W-WH	Eyeball with Black Baffle Eyeball with White Baffle	50W PAR20/R20
	 529-WH 529-SC 529-ABZ	PAR30 Eyeball	50W PAR30
	 209-WH	Gimbal Ring with Flat Trim	35W PAR30
	 688B-WH 688W-WH	Gimbal Ring with Black Baffle Gimbal Ring with White Baffle	35W PAR30
	 689C-WH 689G-WH	Gimbal Ring in Clear Cone Gimbal Ring in Gold Cone	35W PAR30
	 212-WH ◆ 212-SC ◆ 212-ABZ ◆	Frosted Lens with Clear Center	35W PAR30

Trim Size: 6¼" O.D. (except Cat No. 529 - 6½" O.D.)

Trim Finish: ABZ - Classic Aged Bronze, SC - Satin Chrome, WH - White.

Alzak is a registered trademark of Alcoa Corp.

Note: In Canada when insulation is present, Type IC fixtures must be used.

 JUNO IC housings meet IECC Energy Code requirements per ASTM E283.
Air-Loc® rated trims are pre-gasketed for minimum air leakage with IC housings.

◆ UL Listed for use in wet location.

◆◆ UL Listed for use in wet location with outdoor rated lamp.