



# 5" SHALLOW UNIVERSAL IC HOUSING

INCANDESCENT LAMPS

**IC25S**

Project: \_\_\_\_\_

Fixture Type: \_\_\_\_\_

Location: \_\_\_\_\_

Contact/Phone: \_\_\_\_\_

## PRODUCT DESCRIPTION

IC Air-Loc® Housing • Energy efficient, sealed housing • Can be completely covered with insulation • When used with Air-Loc Gasket (see accessories), stops infiltration and exfiltration of air, reducing heating and cooling costs • Trims shown with Air-Loc symbol  do not require a gasket.

## PRODUCT SPECIFICATIONS

**Lamp** Lamp ratings based on trim selected—see reverse.

**Socket** Medium base porcelain with nickel-plated copper screw shell • Floating socket with spring attaches to trim for installation.

**Trims** Trim selection shown on reverse.

**Labels** UL/cUL listed for through-branch wiring, damp locations and IP • Product thermally protected against improper use of lamps • Union made AFL-CIO • UL and cUL Listed • Trim No. 212 is wet location approved for covered ceiling applications • Trims 275 and 276 are wet location approved for covered ceiling applications, **when used with outdoor rated PAR lamps.**

**Testing** All reports are based on published industry procedures; field performance may differ from laboratory performance.

Product specifications subject to change without notice.

## INSTALLATION

**Real Nail® Bar Hangers** Telescoping Real Nail® system permits quick placement of housing anywhere within 24" O.C. joists, or suspended ceilings • Bars scored in two locations for fast clean breaking allowing housing installation in tight applications

- Edge-mounted for extra strength and captive to mounting frame
- Features Real Nail captive nail system for quick one-step installation
- May be installed either perpendicular or parallel to junction box
- Quick-Loc slot (location identified on the mounting frame) and oversized locking set screw lock fixture in position.

**Junction Box** Pre-wired junction box provided with (5) ½" and (1) ¾" knockouts, (4) Non-metallic sheathed cable connectors and ground wire, UL/cUL Listed for through branch wiring, maximum 8 No. 12 AWG 90° C branch circuit conductors (4 in, 4 out)

- Junction box provided with removable access plates
- Knockouts equipped with pryout slots.

**Mounting Frame** 22-gauge die-formed galvanized steel mounting frame • Rough-in section (junction box, mounting frame, housing and bar hangers) fully assembled for ease of installation

- Sight lines embossed on mounting frame to allow for easy viewing when aligning fixtures.

**Housing** IC housing, .032" aluminum sealed for Air-Loc Compliance • Housing is vertically adjustable to accommodate up to a 1" ceiling thickness.

## DIMENSIONS

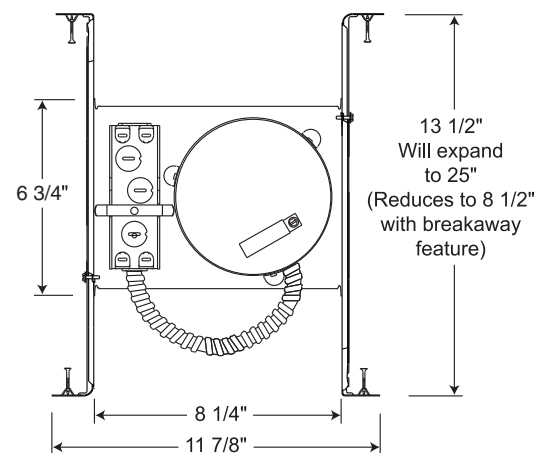
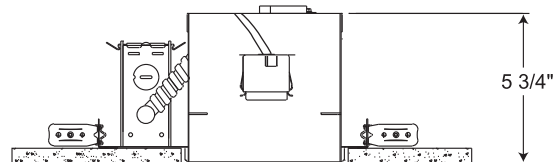

5 5/8" CEILING CUTOUT

## ACCESSORIES

Catalog No.	Description
<b>G2405</b>	T-Bar Clips (Set of 4)
<b>ALG5</b>	Air-Loc Gasket

To order, specify catalog number.

## PRODUCT CODES











Catalog Number	Input Voltage	Lamp Rating (max.)
<b>IC25S</b>	120V	R20/PAR20/BR30/PAR30/PAR30L (See reverse for max. trim rating)

# 5" SHALLOW UNIVERSAL IC HOUSING

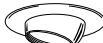
## INCANDESCENT LAMPS

### IC25S

#### TRIMS/LAMPS

	Cat. No.	Description	Max. Lamp Rating
	 <b>275B-WH ♦♦</b> <b>275W-WH ♦♦</b>	Shallow Baffle - Black Shallow Baffle - White	50W BR30, 50W PAR30, 50W PAR30L
	 <b>276B-WH ♦♦</b> <b>276C-WH ♦♦</b> <b>276HZ-WH ♦♦</b> <b>276WHZ-WH ♦♦</b> <b>276W-WH ♦♦</b>	Shallow Cone - Black Alzak® Shallow Cone - Clear Alzak® Shallow Cone - Haze Shallow Cone - Wheat Haze Shallow Cone - White	50W BR30, 50W PAR30, 50W PAR30L
	 <b>208B-WH</b> <b>208W-WH</b>	Eyeball with Black Baffle Eyeball with White Baffle	50W PAR20/R20
	 <b>529-WH</b> <b>529-SC</b> <b>529-ABZ</b>	PAR30 Eyeball	50W PAR30
	 <b>209-WH</b>	Gimbal Ring with Flat Trim	35W PAR30
	 <b>688B-WH</b> <b>688W-WH</b>	Gimbal Ring with Black Baffle Gimbal Ring with White Baffle	35W PAR30
	 <b>689C-WH</b> <b>689G-WH</b>	Gimbal Ring in Clear Cone Gimbal Ring in Gold Cone	35W PAR30
	 <b>212-WH ♦</b> <b>212-SC ♦</b> <b>212-ABZ ♦</b>	Frosted Lens with Clear Center	35W PAR30

Trim Size: 6¼" O.D. (except Cat No. 529 - 6½" O.D.)

Trim Finish: ABZ - Classic Aged Bronze, SC - Satin Chrome, WH - White.

Alzak is a registered trademark of Alcoa Corp.

Note: In Canada when insulation is present, Type IC fixtures must be used.

 JUNO IC housings meet IECC Energy Code requirements per ASTM E283.  
Air-Loc® rated trims are pre-gasketed for minimum air leakage with IC housings.

♦ UL Listed for use in wet location.

♦♦ UL Listed for use in wet location with outdoor rated lamp.