



Project: _____

Fixture Type: _____

Location: _____

Contact/Phone: _____

4" VERTICAL IC COMPACT FLUORESCENT REMODEL HOUSING

18W COMPACT FLUORESCENT LAMP

ICPL418RE



DIMENSIONS

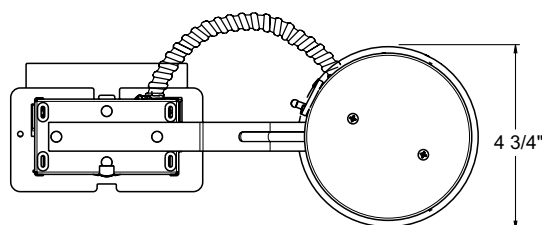
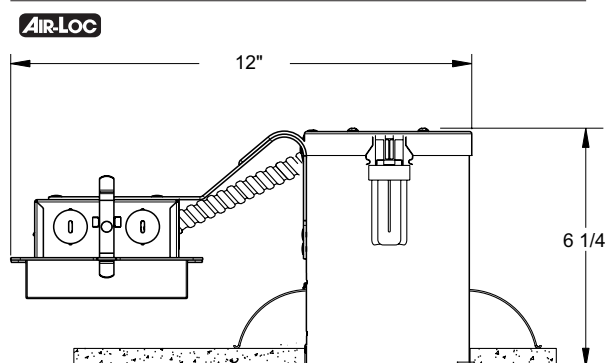

4 3/8" CEILING CUTOUT

PRODUCT DESCRIPTION

ICPL Energy Star, Air-Loc® sealed remodel housing • Can be completely covered with insulation • When used with supplied ALG kit, stops infiltration and exfiltration of air, reducing heating and air cooling costs • 2 year warranty.

PRODUCT SPECIFICATIONS

Lamp One 18W Triple Tube (4-pin) CFL lamp.

Socket Fixed mounted socket attaches to top of housing.

Ballast 120V HPF Rapid Start Electronic with end-of-life lamp protection • UL listed/CSA certified.

Trims Trim selection shown on reverse.

Labels Energy Star qualified • UL listed for damp locations
 • Meets Washington State Air Tight Requirements, IECC
 • Complies with FCC Part 18 consumer use limits • Product mechanically protected against improper use of lamps • Union made • UL and C-UL Listed • Complies with California's Title 24 energy code • Trims 12, 4101 and 4102 are wet location approved for covered ceiling applications.

Testing All reports are based on published industry procedures; field performance may differ from laboratory performance.

Product specifications subject to change without notice.

INSTALLATION

Junction Box Pre-wired junction box UL and C-UL Listed • Junction box provided with removable access plate, (5) 1/2" knockouts, (4) Non-metallic sheathed cable connectors and ground wire • Knockouts equipped with pryout slots.

Housing .032" aluminum housing • Remodel springs accommodate up to 1 1/8" ceiling thickness.

PRODUCT CODES































Catalog Number	Input Voltage	Lamp Rating (max.)
ICPL418RE	120V	18W Triple Tube (4-pin) CFL

4" VERTICAL IC COMPACT FLUORESCENT REMODEL HOUSING

18W COMPACT FLUORESCENT LAMP

ICPL418RE

TRIMS/LAMPS

	Cat. No.	Description	Max. Lamp Rating		Cat. No.	Description	Max. Lamp Rating
	13-WH	2" Pinhole with Integral Shield	18W Triple Tube (4-pin) CFL lamp		4101-WH ♦	Beveled Dome Shower	18W Triple Tube
	148-WH	Black Baffle	18W Triple Tube (4-pin) CFL lamp		4101-SC ♦	Beveled Dome Shower	18W Triple Tube
	148-SC	Black Baffle			4101-ABZ ♦	Beveled Dome Shower	(4-pin) CFL lamp
	148-ABZ	Black Baffle			4102-WH ♦	Beveled Shower	18W Triple Tube
	148-BL	Black Baffle			4102-SC ♦	Beveled Shower	(4-pin) CFL lamp
	14W-WH	White Baffle		4102-ABZ ♦	Beveled Shower		
	17CL-WH	Cone - Clear Low Iridescent Alzak®	18W Triple Tube (4-pin) CFL lamp		4103FROST-WH	Beveled Cylinder	18W Triple Tube
	17G-WH	Cone - Gold Alzak®			4103FROST-SC	Beveled Cylinder	(4-pin) CFL lamp
	17B-WH	Cone - Black Alzak®			4104HZ-SC	Beveled Cone	18W Triple Tube
	17PT-SC	Cone - Pewter Alzak®			4104WHZ-ABZ	Beveled Cone	(4-pin) CFL lamp
	17W-WH	Cone - Glass White			4150MESH-SC	Cylinder	18W Triple Tube
	17HZ-WH	Cone - Haze					(4-pin) CFL lamp
	17WHZ-WH	Cone - Wheat Haze					
	17WHZ-ABZ	Cone - Wheat Haze					
	12W-WH ♦	Shower Trim, frosted perimeter lens	18W Triple Tube				
	12W-SC ♦	Shower Trim, frosted perimeter lens	(4-pin) CFL lamp				
	12W-ABZ ♦	Shower Trim, frosted perimeter lens					

Trim Size: 5" O.D.

Trim Finish: ABZ - Classic Aged Bronze, BL -Black, SC - Satin Chrome, WH - White.
Alzak is a registered trademark of Alcoa Corp.

Note: In Canada when insulation is present, Type IC fixtures must be used.

 JUNO IC housings meet IECC Energy Code requirements per ASTM E283.
Air-Loc® rated trims are pre-gasketed for minimum air leakage with IC housings.

♦ UL Listed for use in wet location.