

JUNO**2" IC 600 AND 1000 LUMENS
LED ROUND DOWNLIGHT CONE**

Project: _____

Fixture Type: _____

Location: _____

Contact/Phone: _____

**GEN2****PRODUCT DESCRIPTION**

2 inch aperture recessed downlight is IC rated for insulated or non-insulated applications • Luminaire produces up to 1000 lumens and is available with optical distributions approximating that of 75W MR16 halogen lamps • Low profile form factor allows luminaire to fit in 2 x 6 construction • Designed to provide 50,000 hours of life • 5 year limited warranty on LED Components.

ENVIRONMENTALLY FRIENDLY, ENERGY EFFICIENT

- No harmful ultraviolet or infrared wavelengths
- No lead or mercury, RoHS compliant
- Comparable light output up to a 75W MR16 halogen lamp

PRODUCT SPECIFICATIONS

LED Light Engine Exceptional fixture to fixture color consistency within a 3-step MacAdam ellipse • 2700K, 3000K, 3500K, and 4100K color temperatures are available with 80 CRI or 90 CRI minimum.

Modular Optics Available with field interchangeable optics in 18° Spot, 24° Narrow Flood, or 40° Flood distributions.

Aesthetic Trim Trim features die cast beveled knife edge trim ring for clean ceiling interface available in white, black, satin nickel, or brushed bronze • Spun aluminum reflectors are available in clear, haze, wheat haze, black and white finishes.

LED Driver Choice of dedicated 120 volt driver or universal voltage driver that accommodates input voltages from 120-277 volts AC at 50/60Hz • Power factor > 0.9 • Dedicated 120 volt driver (120) is dimmable with the use of most incandescent, magnetic low voltage and electronic low voltage dimmers • Universal voltage driver (MVOLT) is dimmable with the use of most 0-10V protocol dimmers • For a list of compatible dimmers, see [JUNO2ING2-DIM](#).

Life Rated for 50,000 hours at 70% lumen maintenance.

Labels ENERGY STAR® Qualified • 90CRI fixtures are certified to the high efficacy requirements of California T24 • Meets energy code Air Leakage requirements per ASTM E283 • UL and cUL listed for wet locations.

Junction Box Includes (2) ½" knock-outs equipped with pryout slots • Push-in electrical connectors for field connections.

Mounting Remodel style plaster frame installs from below the ceiling and accommodates ceiling thicknesses from ½" to 1" • For thicker ceilings up to 1 ½", order 2-JCTA150 • New Construction mounting frame, 2-NCMF, is also available with Patented (US Patent D552,969) Real Nail 3® telescoping bar hangers to position fixture and locate wiring prior to ceiling installation • Recommend a minimum of 5.5" cavity depth to install properly • Flexible supply is recommended and non-flexible supply requires top access.

Product specifications subject to change without notice.

ENGINEERING DATA (600L)

	Dedicated 120V (120)	Universal Voltage (MVOLT)	
Voltage	120	120	277
Input Power	7.5 (±5%)	7.2	7.5 (±5%)
Input Current	.06	.06	.03
Frequency	50/60Hz	50/60Hz	
Power Factor	>0.9	>0.9	>0.9

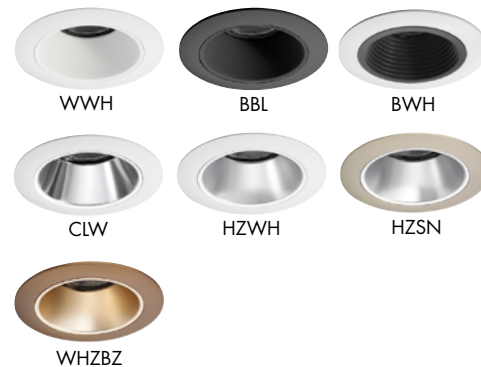
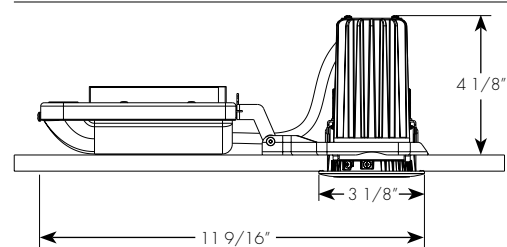
**Downlight Cone Finishes****DIMENSIONS**

2 5/8" CEILING CUTOUT
2" APERTURE

ENGINEERING DATA (1000L)

	Dedicated 120V (120)	Universal Voltage (MVOLT)	
Voltage	120	120	277
Input Power	11.5 (±5%)	10.9	11.4 (±5%)
Input Current	.10	.09	.04
Frequency	50/60Hz	50/60Hz	
Power Factor	>0.9	>0.9	>0.9

2" IC 600 AND 1000 LUMENS LED ROUND DOWNLIGHT CONE

GEN2

ORDERING INFORMATION: DRIVER AND TRIM EACH ORDERED SEPARATELY

DRIVER:

Example: **2LEDDRVG2-10-120**

Series	Gen	Lumens	Drivers
2LEDDRV	G2	6 600 Lumens 10 1000 Lumens	120 Dedicated 120V Only (Forward Phase + ELVDimmable)

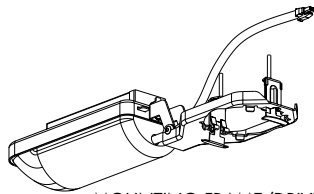

MOUNTING FRAME/DRIVER ASSEMBLY

MVOLT Universal Voltage 120-277V (0-10V Dimmable)

Note: Driver assembly only intended for use with Gen2 LED trim modules. Not backward compatible with previous generation.

TRIM:

Example: **2LEDTG2C-827S-HZWH**

Series	Gen	Trim Type	CRI	CCT	Beam Optics	Finish
2LEDT	G2	C Downlight Cone	8 80CRI 9 90CRI	27 2700K 30 3000K 35 3500K 41 4100K	S 18° Spot N 24° Narrow Flood F 40° Flood	WWH White Cone, White Trim Ring BBL Black Cone, Black Trim Ring BWH Black Cone, White Trim Ring CLW Clear Cone, White Trim Ring HZWH Haze Cone, White Trim Ring HZSN Haze Cone, Satin Nickel Trim Ring WHZBZ* Wheat Haze Cone, Bronze Trim Ring

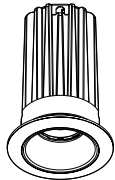

TRIM/LED ASSEMBLY

*When ordering WHZBZ finish, remove dash between trim type and CRI.
Ordering example: 2LEDTG2C827S-WHZBZ

ACCESSORIES

Catalog No.	Description
2-NCMF	New Construction Mounting Frame with Real Nail® 3 bar hangers
2-JCTA150	Thick Ceiling adapter for 1" - 1½" thick ceiling
LEDOPTIC2-S	18° Spot Optic
LEDOPTIC2-N	24° Narrow Flood Optic
LEDOPTIC2-F	40° Flood Optic

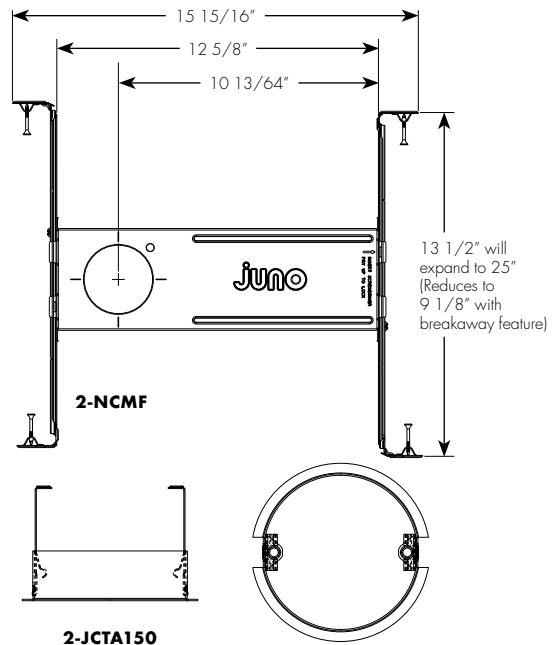

2" IC 600 AND 1000 LUMENS LED ROUND DOWNLIGHT BAFFLE GEN2

PHOTOMETRIC REPORT

Test Report#: PTO7162131
Catalog No: 2LEDTG2C-835S-CLW (600L)
80CRI, 3500K LED, Clear Cone
with Spot Optic
Luminaire Spacing Criteria: 0.34
Luminaire LPW: 103

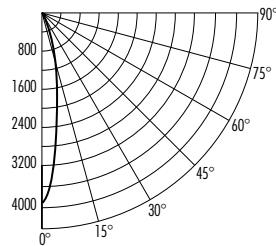

CANDLEPOWER DISTRIBUTION (Candelas)

Degrees Vertical	0°
0	3972
5	3449
15	1007
25	318
35	53
45	12
55	2
65	0
75	0
85	0
90	0

AVERAGE INITIAL FOOTCANDLES Multiple Units (Square Array, 60'x60' room)

Reflectances: Ceiling 80%, Wall 50%, Floor 20%

Spacing	RCR1	RCR3	RCR5
4'	55	50	46
5'	35	32	29
6'	24	22	20
7'	20	18	17
8'	16	14	13
9'	12	11	10
10'	9	8	7

ZONAL LUMEN SUMMARY

Zone	Lumens	%Lamp	%Fixture
0-30°	718	N/A	92.8
0-40°	762	N/A	98.5
0-60°	774	N/A	100.0
0-90°	774	N/A	100.0

INITIAL FOOTCANDLES (One Unit, 7.5W, 19.6° Beam)

Distance to Illuminated Plane (Feet)	Footcandles Beam Center	Beam Diameter
4'	248.3	1.4
6'	110.3	2.1
8'	62.1	2.8
10'	39.7	3.5
12'	27.6	4.1

LUMINANCE (Average cd/m²)

Degrees	Average Luminance
45°	6383
55°	1455
65°	0
75°	0
85°	0

PHOTOMETRIC REPORT

Test Report#: PTO7162136
Catalog No: 2LEDTG2C-835N-CLW (600L)
80CRI, 3500K LED, Clear Cone
with Narrow Flood Optic
Luminaire Spacing Criteria: 0.42
Luminaire LPW: 100

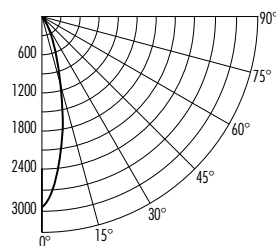

CANDLEPOWER DISTRIBUTION (Candelas)

Degrees Vertical	0°
0	2963
5	2681
15	1032
25	344
35	64
45	11
55	3
65	0
75	0
85	0
90	0

AVERAGE INITIAL FOOTCANDLES Multiple Units (Square Array, 60'x60' room)

Reflectances: Ceiling 80%, Wall 50%, Floor 20%

Spacing	RCR1	RCR3	RCR5
4'	53	48	43
5'	34	30	28
6'	23	21	19
7'	19	17	16
8'	15	14	12
9'	11	10	9
10'	8	8	7

ZONAL LUMEN SUMMARY

Zone	Lumens	%Lamp	%Fixture
0-30°	686	N/A	91.8
0-40°	735	N/A	98.3
0-60°	747	N/A	100.0
0-90°	747	N/A	100.0

INITIAL FOOTCANDLES (One Unit, 7.5W, 24.3° Beam)

Distance to Illuminated Plane (Feet)	Footcandles Beam Center	Beam Diameter
4'	185.2	1.7
6'	82.3	2.6
8'	46.3	3.4
10'	29.6	4.3
12'	20.6	5.2

LUMINANCE (Average cd/m²)

Degrees	Average Luminance
45°	5900
55°	1785
65°	0
75°	0
85°	0

PHOTOMETRIC REPORT

Test Report#: PTO7162141
Catalog No: 2LEDTG2C-835F-CLW (600L)
80CRI, 3500K LED, Clear Cone
with Flood Optic
Luminaire Spacing Criteria: 0.58
Luminaire LPW: 103

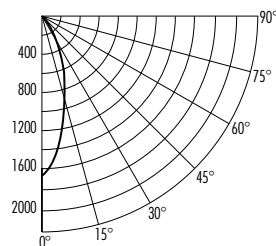

CANDLEPOWER DISTRIBUTION (Candelas)

Degrees Vertical	0°
0	1669
5	1524
15	968
25	519
35	167
45	21
55	3
65	0
75	0
85	0
90	0

AVERAGE INITIAL FOOTCANDLES Multiple Units (Square Array, 60'x60' room)

Reflectances: Ceiling 80%, Wall 50%, Floor 20%

Spacing	RCR1	RCR3	RCR5
4'	54	48	43
5'	35	31	28
6'	24	21	19
7'	20	17	15
8'	15	14	12
9'	12	10	9
10'	9	8	7

ZONAL LUMEN SUMMARY

Zone	Lumens	%Lamp	%Fixture
0-30°	644	N/A	83.1
0-40°	752	N/A	97.1
0-60°	775	N/A	100.0
0-90°	775	N/A	100.0

INITIAL FOOTCANDLES (One Unit, 7.5W, 35.7° Beam)

Distance to Illuminated Plane (Feet)	Footcandles Beam Center	Beam Diameter
4'	104.3	2.6
6'	46.4	3.9
8'	26.1	5.2
10'	16.7	6.4
12'	11.6	7.7

LUMINANCE (Average cd/m²)

Degrees	Average Luminance
45°	11157
55°	1785
65°	0
75°	0
85°	0

Fixtures tested to IES recommended standard for solid state lighting per LM-79-08. Photometric performance on a single unit represents a baseline of performance for the fixture. Results may vary in the field.

Multiplier:	80 CRI	90 CRI
	827 = .94	927 = .83
	830 = .97	930 = .86
	835 = 1.00	935 = .88
	841 = 1.03	940 = .90



2" IC 600 AND 1000 LUMENS LED ROUND DOWNLIGHT BAFFLE GEN2

PHOTOMETRIC REPORT

Test Report#: PTO7162131R
Catalog No: 2LEDTG2C-835S-CLW (1000L)
80CRI, 3500K LED, Clear Cone
with Spot Optic
Luminaire Spacing Criteria: 0.34
Luminaire LPW: 102

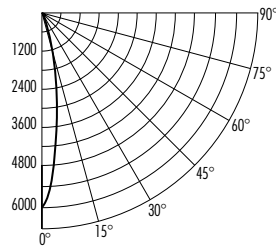

CANDLEPOWER DISTRIBUTION (Candelas)

Degrees Vertical	0°
0	5997
5	5209
15	1520
25	481
35	80
45	18
55	3
65	0
75	0
85	0
90	0

AVERAGE INITIAL FOOTCANDLES Multiple Units (Square Array, 60'x60' room)

Reflectances: Ceiling 80%, Wall 50%, Floor 20%

Spacing	RCR1	RCR3	RCR5
4'	83	75	69
5'	53	48	44
6'	37	33	31
7'	30	27	25
8'	23	21	20
9'	18	16	15
10'	13	12	11

ZONAL LUMEN SUMMARY

Zone	Lumens	%Lamp	%Fixture
0-30°	1085	N/A	92.8
0-40°	1151	N/A	98.5
0-60°	1168	N/A	100.0
0-90°	1169	N/A	100.0

INITIAL FOOTCANDLES (One Unit, 11.5W, 19.6° Beam)

Distance to Illuminated Plane (Feet)	Footcandles Beam Center	Beam Diameter
4'	374.8	1.4
6'	166.6	2.1
8'	93.7	2.8
10'	60.0	3.5
12'	41.6	4.1

LUMINANCE (Average cd/m²)

Degrees	Average Luminance
45°	9638
55°	2197
65°	0
75°	0
85°	0

PHOTOMETRIC REPORT

Test Report#: PTO7162136R
Catalog No: 2LEDTG2C-835N-CLW (1000L)
80CRI, 3500K LED, Clear Cone
with Narrow Flood Optic
Luminaire Spacing Criteria: 0.42
Luminaire LPW: 99

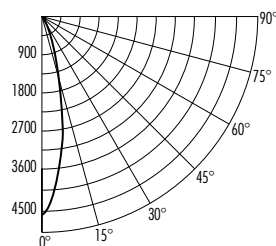

CANDLEPOWER DISTRIBUTION (Candelas)

Degrees Vertical	0°
0	4533
5	4102
15	1579
25	526
35	98
45	17
55	4
65	0
75	0
85	0
90	0

AVERAGE INITIAL FOOTCANDLES Multiple Units (Square Array, 60'x60' room)

Reflectances: Ceiling 80%, Wall 50%, Floor 20%

Spacing	RCR1	RCR3	RCR5
4'	81	73	66
5'	52	47	43
6'	36	32	30
7'	29	26	24
8'	23	21	19
9'	18	16	14
10'	13	12	11

ZONAL LUMEN SUMMARY

Zone	Lumens	%Lamp	%Fixture
0-30°	1049	N/A	91.8
0-40°	1124	N/A	98.3
0-60°	1143	N/A	100.0
0-90°	1143	N/A	100.0

INITIAL FOOTCANDLES (One Unit, 11.5W, 24.3° Beam)

Distance to Illuminated Plane (Feet)	Footcandles Beam Center	Beam Diameter
4'	283.3	1.7
6'	125.9	2.6
8'	70.8	3.4
10'	45.3	4.3
12'	31.5	5.2

LUMINANCE (Average cd/m²)

Degrees	Average Luminance
45°	9027
55°	2732
65°	0
75°	0
85°	0

PHOTOMETRIC REPORT

Test Report#: PTO7162141R
Catalog No: 2LEDTG2C-835F-CLW (1000L)
80CRI, 3500K LED, Clear Cone
with Flood Optic
Luminaire Spacing Criteria: 0.58
Luminaire LPW: 104

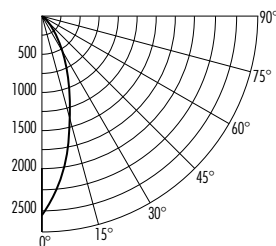

CANDLEPOWER DISTRIBUTION (Candelas)

Degrees Vertical	0°
0	2571
5	2346
15	1490
25	799
35	256
45	32
55	4
65	0
75	0
85	0
90	0

AVERAGE INITIAL FOOTCANDLES Multiple Units (Square Array, 60'x60' room)

Reflectances: Ceiling 80%, Wall 50%, Floor 20%

Spacing	RCR1	RCR3	RCR5
4'	84	74	66
5'	53	47	42
6'	37	33	29
7'	30	27	24
8'	24	21	19
9'	18	16	14
10'	13	12	11

ZONAL LUMEN SUMMARY

Zone	Lumens	%Lamp	%Fixture
0-30°	991	N/A	83.1
0-40°	1159	N/A	97.1
0-60°	1193	N/A	100.0
0-90°	1193	N/A	100.0

INITIAL FOOTCANDLES (One Unit, 11.5W, 35.7° Beam)

Distance to Illuminated Plane (Feet)	Footcandles Beam Center	Beam Diameter
4'	160.7	2.6
6'	71.4	3.9
8'	40.2	5.2
10'	25.7	6.4
12'	17.9	7.7

LUMINANCE (Average cd/m²)

Degrees	Average Luminance
45°	17182
55°	2750
65°	0
75°	0
85°	0

Fixtures tested to IES recommended standard for solid state lighting per LM-79-08. Photometric performance on a single unit represents a baseline of performance for the fixture. Results may vary in the field.

Multiplier:	80 CRI	90 CRI
	827 = .94	927 = .83
	830 = .97	930 = .86
	835 = 1.00	935 = .88
	841 = 1.03	940 = .90